



**UNION INTERNATIONALE
MOTONAUTIQUE**

**CIRCUIT
RULES**

2007

2006 CIRCUIT WORLD CHAMPIONS

Formula 1



GILLMAN Scott - USA

Formula 2000



JELF Colin - Great Britain

Formula 500



HAVAS Attila - Austria

Formula 4



ERIKSON Christoffer - Finland

O 350



KIEPE-KIPGE Eriks - Latvia

SST 45



MENDENA Jose - USA

SST 120



VOISIN Vince - USA

O 175



TENNELL Buddy - USA

S 550



RYBARCZYK Lechoslaw - Poland

OSY 400



ONGARI Andrea - Italy

F 1000



DEL PIN Roberto - Italy

O 125



COLOMBI Luigi - Italy

O 700



HAVAS Attila - Austria

O 250



POLITI Michelangelo - Italy

T 550



LABEDZKI Adam - Poland

Unlimited Hydroplane



THEORET Jean - Canada

2006 CIRCUIT WORLD CHAMPIONS

P 750 INFLATABLE



LINDEQUE Stefan - South Africa BRINK Philip - South Africa

PR 550



CARANDO Claudia - Italy CARANDO Stefania - Italy

APBA GRAND PRIX HYDROPLANE



LUPTON Warwick - New Zealand

APBA 2.5 L MODIFIED HYDROPLANE



ECHOLS Dustin - USA

2006 CIRCUIT ENDURANCE WORLD CHAMPIONS

CLASS 1



DRON Cyrille - France

RUFFIN Alexandre - France

TALENT Frederic - France

CLASS 2



BOURDIN Tony - France

LEMOINE Sebastien - France

LEMOINE Stephane - France

CLASS 3



MORIN Nelson - France

MORIN Peter - France

2006 RIVER MARATHON WORLD CHAMPIONS

JET BOAT

Class A



RINGER Ryan - USA



KEMP Brett - USA

Class B



BURNS Chad - Canada



BURNS Willie - Canada

Class SP 2500



GARCIA TORRES Virgillio
Mexico



AARON SALCEDO José
Mexico

Class U



WHITESIDE Dale
Canada



MARTLY Dana
Canada

2006 FORMULA FUTURE WORLD CHAMPIONS



Class 1
MUHAMMAD HANIF
bin RAMLI
Malaysia



Class 2
SYAZWAN
bin MOHD NOR
Malaysia



Class 3
FEVOLA Vincenzo
Italy



Class 4
KOMM Tobias
Germany



Class 5
MUHAMMAD AKMAL
bin KAMALUDIN
Malaysia

2006 ENDURANCE PNEUMATICS

CLASS 1



SMIRNOV Yury
Russia



DROZDOV Anatoly
Russia



KRUGOV Alexei
Russia



PAL Eugeny
Russia

CLASS 2



SIDOROV Aleksandr
Latvia



JUFIMEC Andreis
Latvia



AVEROCHKIN Nikolay
Russia



PULIAK Vladimir
Russia

CLASS 3



ANDREEV Boris
Russia



KODRATENKO Vadim
Russia



BORZENKO Eugeny
Russia



BARANOV Yuri
Russia

CLASS 4



VASILJEV Andrey
Russia



KIJATKIN Vladimir
Russia



KOJINOV Alexandr
Russia



KUZNETSOV Sergey
Russia

CLASS 5



OSIPOV Venjamin
Russia



OVCHINNIKOV Andrey
Russia



NOSKOV Aleksey
Estonia



WARTINGER Robert Louis
USA

2006 CIRCUIT EUROPEAN CHAMPIONS



Formula 350
FEIL Janos
Austria



Formula 125
METS Thomas
Estonia



Formula 250
DICKFORS Olle
Sweden



Formula1000
DEL PIN Roberto
Italy



Formula R 1000
GEBERT Reinhard
Germany



O 500
HAVAS Attila
Austria



O 700
HAVAS Attila
Austria



OSY 400
BAZINSKY Miroslav
Slovakia



S 550
RYBARCZYK
Lechoslaw
Poland



T 850
SANDOR Peter
Hungary



T 550
LABEDZKI Adam
Poland



T 400
MANNINEN Juha-Pekka
Finland



JT 250
BROLITIS Arturs
Latvia

2006 FORMULA FUTURE EUROPEAN CHAMPIONS



Class 1
REH Steven
Germany



Class 2
SIEGLE Felix
Germany



Class 3
KASIMOV Georgy
Russia



Class 4
KOMM Tobias
Germany



Class 5
FEDOROV Denis
Russia

GROUP 100

U.I.M. Administration

- 101 **CALENDAR**
 - 101.01 - INSCRIPTION FEE
 - 101.02 - OTHER MEETINGS
 - 101.03 - DEADLINE DATES
 - 101.04 - LATE REQUEST, CHANGE OF DATE AND CANCELLATION
- 102 **COMMISSIONERS**
 - 102.01 - GENERAL
 - 102.02 - FUNCTIONS
 - 102.03 - AFTER THE RACE
 - 102.04 - ACCOMMODATION AND TRAVEL
- 103 **RECOGNISED RACES**
- 104 **NON APPROVED RACES**
- 105 **TITLED INTERNATIONAL EVENTS**
- 106 **INTERNATIONAL CHAMPIONSHIP**
 - 106.01 - GENERAL RULES
 - 106.02 - WATER REGISTRATION
- 107 **WORLD CHAMPIONSHIPS**
- 108 **CONTINENTAL AND WORLD CHAMPIONSHIPS**
 - 108.01 - NUMBER OF CHAMPIONSHIPS
 - 108.02 - EUROPEAN CHAMPIONSHIP SERIES
 - 108.03 - ENTRIES
 - 108.04 - HEATS AND LENGTH
 - 108.05 - REPAIRS AND MEASURING
 - 108.06 - RESULTS
- 109 **ENDURANCE RACES**
 - 109.01 - DEFINITIONS
- 110 **ENDURANCE CHAMPIONSHIP**
 - 110.01 - DEFINITIONS
- 111 **HANDICAP**
- 112 **RULES FOR DRAG RACES**
 - 112.01 - DEFINITIONS

- 120 **RACING LICENCES**
 120.01 - COMPULSORY LICENCE
 120.02 - REGISTRATION
 120.03 - VALIDITY OF LICENCES
 120.04 - COST OF LICENCE
 120.05 - EXAMINATION OF LICENCES
 120.06 - CANCELLATION OF LICENCE
 120.07 - PSEUDONYM
 120.08 - SUPER-LICENCE ENDORSEMENT FOR WORLD FORMULA SERIES
 RACING

GROUP 200

- 200 **ORGANISATION OF THE RACES**
 200.01 - GENERAL
 200.02 - INTERPRETATION OF THE RULES
- 201 **ORGANISING BODIES**
 201.01 - RACE COMMITTEE
 201.02 - INTERNATIONAL OFFICERS LISTS
 201.03 - THE OFFICER OF THE DAY (OOD)
 201.04 - THE DEPUTY OFFICER OF THE DAY
 201.04.01 - THE MEDICAL OFFICER
 201.05 - THE RACE SECRETARY
 201.06 - DUTIES OF THE RACE OFFICIALS
 201.07 - THE TECHNICAL OFFICERS
 201.08 - THE BUOY AND COURSE OFFICERS
 201.09 - THE TIMEKEEPERS AND STARTER
- 202 **ADVANCE-PROGRAMME**
 202.01 - FORWARDING DATE
- 203 **ENTRY**
 203.01 - RATIFICATION
 203.02 - ADMISSION
 203.03 - ENTRY FREE
 203.04 - MINIMUM AGE
 203.041 - MINIMUM AGE INTERNATIONAL
 203.05 - NATIONALITY
 203.051 - PUBLICITY ON THE BOATS
- 204 **RACE INSTRUCTIONS**
- 205 **SAFETY RULES**
 205.01 - ANNUAL MEDICAL EXAMINATION
 205.02 - MEDICAL EXAMINATION AT EVENT
 205.02.01 - MEDICAL EXAMINATION FOR SUPERLICENCE
 205.02.02 - DOPING TEST CONSUMPTION OF ALCOHOL
 205.02.03 - ANTI-DOPING REGULATIONS
 205.03 - MEDICAL EVALUATION SHEET
 205.04 - GENERAL OBJECTIVE EXAMINATION
 205.05 - UNDERWATER TRAINING
 205.06 - LIFE JACKET
 205.07 - PROTECTING HELMET

- 205.08 - SAFETY BOATS
 - 205.08.01 - TOWING BOATS
 - 205.08.02 - FIRST AID STATION
 - 205.09 - INSURANCE
 - 205.10 - TECHNICAL PROTECTION
 - 205.11 - CLOTHING PROTECTION
 - 205.12 - LIFTING OF RACEBOATS
- 206 **DISTINCTIVE MARKS**
- 206.01 - NATIONALITY
 - 206.02 - NUMBERS
 - 206.03 - LOSS OF RACE NUMBER
 - 206.04 - UIM STICKERS

GROUP 300

- 300 **RULES FOR CIRCUIT RACE**
 - 300.01 - DEFINITIONS
- 301 **TIMING**
- 302 **CIRCUIT**
 - 302.02 - RACE CONTROL
- 303 **MARKS OF THE COURSE**
 - 303.01 - DEFINITIONS
- 304 **SIGNALS FROM THE SHORE**
 - 304.01 - CALL SIGNALS
 - 304.02 - FLAG SIGNALS
 - 304.03 - STARTING IN GROUPS
- 305 **STARTING SIGNALS**
- 306 **FLYING START WITH CLOCK, DISCS AND GUN**
 - 306.01 - PLACE OF THE CLOCKS
 - 306.02 - DISCS
 - 306.03 - GUN
 - 306.04 - STARTING LINE
 - 306.05 - SAFETY ZONE
 - 306.06 - BEFORE THE START
 - 306.07 - THE START
 - 306.08 - APPROACHES TO THE STARTING LINE
 - 306.09 - BOAT STARTING BEFORE TIME
- 307 **DEAD ENGINE START FROM A QUAY,
A JETTY OR A BEACH**
- 308 **RACE CANCELLED**
- 309 **RACE POSTPONED**
- 310 **RACE SHORTENED**
- 311 **RACE STOPPED**
 - 311.01 - GENERALITY
 - 311.02 - RACING IN HEATS
 - 311.03 - SINGLE HEAT RACING

- 312 **RULES OF THE ROAD**
 - 312.02 - OVERLAP
 - 312.08 - OVERTAKING
 - 312.11 - PASSING MARKS
 - 312.12 - ALTERING COURSE
- 313 **ROUNDING AND FOULING MARKS**
- 314 **FOULING COMPETING BOATS**
- 315 **MEANS OF PROPULSION**
- 317 **FINISHING A RACE**
 - 317.01 - THE FINISH
- 318 **CLASSIFICATION**
- 319 **DEAD HEAT**
- 320 **POSTING OF THE RESULTS**
- 321 **INSPECTION OF HULLS; ENGINES MOTORS**
- 322 **THE PRIZES**
- 323 **AFTER THE MEETING (REPORTS)**

GROUP 400

- 401 **DEFINITIONS**
- 402 **JUDICIAL BODIES**
 - 402.01 - THE INTERNATIONAL JURY
 - 402.02 - INTERESTED PARTIES
 - 402.03 - THE U.I.M. APPEALS BOARD
- 403 **PROTESTS PROCEDURES**
 - 403.01 - VALIDITY OF PROTESTS
 - 403.02 - PROTEST FEE
 - 403.03 - RIGHT OF PROTEST
 - 403.04 - TIME TO LODGING A PROTEST
 - 403.05 - JUDGEMENT
 - 403.06 - NOTIFICATION OF DECISION
 - 403.07 - AVAILABILITY OF DOCUMENTS
 - 403.08 - RETURN OF FEES
- 404 **HEARING OF THE PROTEST**
 - 404.01 - RIGHT TO A HEARING
 - 404.02 - EVIDENCE
 - 404.03 - THE HEARING PROCEDURE
- 405 **THE APPEALS PROCEDURES**
 - 405.01 - APPEAL BOARD
 - 405.02 - INTERESTED PARTIES
 - 405.03 - RIGHT OF APPEAL
 - 405.04 - NOTICE OF INTENTION TO APPEAL
 - 405.05 - TIME LIMIT
 - 405.06 - LODGING OF AN APPEAL
 - 405.07 - NOTIFICATION OF THE PARTIES OF THE APPEAL
 - 405.08 - TIME LIMIT FOR DECISIONS ON APPEALS
 - 405.09 - APPEAL BOARD DECISIONS
 - 405.10 - COSTS
- 406 **PENALTIES**
 - 406.01 - GENERAL
 - 406.02 - REPRIMAND
 - 406.03 - YELLOW CARD
 - 406.04 - DISQUALIFICATION
 - 406.05 - TEMPORARY SUSPENSION
 - 406.06 - PROLONGED SUSPENSION
 - 406.07 - EXCLUSION

- 407 PRIORITY OF THESE RULES
- 408 POWERBOAT PROTEST FORM
- 409 ACCIDENT REVIEW BOARD

GROUP 500

- 500 SERIES AND CLASSES
 - 500.01 - DEFINITIONS
 - 500.02 - INTERNATIONAL SERIES AND CLASSES
 - 500.03 - RECOGNISED SERIES AND CLASSES
 - 500.04 - ENTRY LEVEL RACING CLASSES
 - 500.10 - FORMULA FUTURE RULES
- 501 MEASUREMENT CERTIFICATE
- 502 INSPECTIONS
- 503 EQUIPMENT - PEOPLE ABOARD - MOTORS
- 504 NOISE REDUCTION
- 505 ENGINE HOMOLOGATION
- 508 FUEL
- 509 REINFORCED COCKPITS
- 510 RACING INBOARDS
- 515 RACING INBOARD - HISTORIC
- 520 RACING OUTBOARDS
- 525 OSY – 400
- 526 OSY R
- 530 SPORTS INBOARDS
- 540 SPORTS OUTBOARDS
- 550 MONOHULL OUTBOARDS
- 560 INFLATABLE BOATS
- 565 RIGID INFLATABLE BOATS
- 570 BOATS WITH DIESEL MOTORS
- 580 TURBO-JETS AND ROCKET PROPELLED BOATS

590 BOATS WITH AERIAL PROPELLER

595 ELECTRIC POWERED BOATS

500 INTERNATIONAL SERIES AND CLASSES

SERIES	CLASSES	HULL	MACHINERY	FUEL
R.510	511	512	513	514
HR.515	516	517	518	519
O.520	521	522	523	524
OSY.525	...	527	528	529
E.530	531	532	533	534
S.550	541	542	543	544
T.550	551	552	553	554
P.560	561	562	563	564
PH.565	566	567	568	569
D.570	571	572	573	574
TR.580	581	582	583	584
A.590	591	592	593	594
EL.595	596	597	598	...

GROUP 600

600 RECORDS AND PERFORMANCES

600.01 - GENERAL

601 CLASSES ELIGIBLE FOR RECORDS

601.01 - QUALIFICATION

602 DEFINITION OF UNITS

602.01 - TIME, DISTANCE AND SPEEDS

602.02 - STATUTE MILE, NAUTICAL MILE AND KILOMETRE

604 THE COURSE

605 CALCULATION OF SPEED

606 MARGIN REQUIRED

607 MOTORS

608 REQUEST TO ORGANISE

609 OFFICIALS

610 SPEED RECORDS

611 DISTANCE RECORDS

612 HOUR RECORDS

613 WORLD COMPETITION RECORDS

614 PERFORMANCE CERTIFICATES

615 HOMOLOGATION OF RECORDS

616 PROTESTS

GROUP 700

- 701 NOISE LEVEL
- 702 EMISSIONS
- 703 RE-FUELLING
- 704 ENVIRONMENTAL

GROUP 800

- 800 CUPS AND TROPHIES
800.01 - INTERNATIONAL CUPS
- 801 ALFRED BUYSSSE CUP
- 802 JOHN WARD TROPHY
- 803 BOUCQUEY TROPHY
- 804 DIETER KONIG MEMORIAL
- 805 JOHN HILL TROPHY

GROUP 900

- 900 RIVER MARATHON RULES
 900.01 - GENERAL
 900.02 - APPLICABLE RULES
 900.03 - RACE COURSE
 900.04 - CREW
 900.05 - EQUIPMENT
 900.06 - TECHNICAL SAFETY REGULATIONS
 900.07 - INSPECTION PROCEDURES
 900.08 - GENERAL RACING RULES
 900.09 - FLAG SIGNALS
 900.10 - STARTING
 900.11 - RACE IN PROGRESS RULES
 900.12 - FINISHING RULES
 900.13 - SUPPORT BOATS
 900.14 - RACE OFFICIALS
 900.15 - INTERNATIONAL RACING CLASSES
- 901 JET SPRINT RULES
 1. GENERAL RULES
 2. BOAT AND SAFETY EQUIPMENT
 3. ROLL CAGE SPECIFICATIONS
 4. INTERNATIONAL JET SPRINT CLASSES
 5. TESTING PROCEDURES
 6. SPORTSMANSHIP AND COMPETITOR CODE OF CONDUCT
 7. EVENT RULES
- 902 ENDURANCE CHAMPIONSHIPS
- 903 RESERVE NUMBER
- 904 HYDRO SPRINT RACING RULES

101 - SPORTS CALENDAR

101.01 - INSCRIPTION FEE

Registration of international races in the annual calendar of the U.I.M. is compulsory and subject to the payment of a fee, the amount of which is fixed annually by the General Assembly.

If two titles are organised at one event, the second calendar fee will be invoiced at 50 %.

If three titles are organised at one event, the second calendar fee will be invoiced at 50 % and the third one at 25 %.

Payment of these fees must be made within three months after the fixing of the international calendar

Permission to organise these meetings is only given by the U.I.M. upon payment of these fees.

No permission is to be granted to National Authorities who are in arrears of payment.

All requests to organise an international championship must be sent to the U.I.M. Secretariat before the time set by the deadline in the rules.

The organisation of an event cannot be granted if the title, the classes to race, the registered race course and the date of the event are not given.

The titled meetings have priority over all other meetings before the closing of the registrations for the sports calendar. However, when the sports calendar is finalised, all the motorboating meetings are on an equal footing.

In order to promote new series and classes, new hulls, motors or engines, new ideas regarding propulsion and new concepts of racing, the Council may, provided the request to organise be accompanied by an amount equal to double the fee of an ordinary meeting, approve the organisation of international contests for such boats, motors or engines, type of propulsion and races of a kind not yet known to the U.I.M. provided such

events do not clash with other U.I.M. titled meetings at the sole discretion of U.I.M.

101.02 - OTHER MEETINGS

It is forbidden to organise national championships for series and classes which are in the programme of a titled meeting taking place the same day.

The calendar of national or local events is not to be submitted to the U.I.M. The interested National Authorities take responsibility for their own calendar.

No U.I.M. national authority in the same continent shall have a race on its calendar of the same class, as a U.I.M. World or Continental Championship on the same date, based upon dates sanctioned at the U.I.M. General Assembly.

101.03 - DEADLINE DATES

- 1 March: Forwarding of requests for international titled events
- 1 April: Allotting of titled events to NA for the following year
- 10 September: Forwarding of dates and venues of titled events by the NAs.
Forwarding of request for ordinary international events, complete with dates and venues.
- November calendar
- Meeting: Drawing-up of the international calendar.
- 15 December: Publishing of the international calendar.

101.04 - LATE REQUEST, CHANGE OF DATE AND CANCELLATION

Titled events

Late request: a late request will be considered only if the title is still vacant or if the title or the event has been cancelled by the NA to whom it was granted or by the U.I.M. If the title is granted, the organiser will pay the normal inscription fee.

Late forwarding of date or venue : the inscription fee will be raised by 50%

Change of date: the inscription fee will be raised by 25 %. The U.I.M. give its assent to the new date. The request for a change of date must be received by the U.I.M. secretariat not less than 90 days before the calendar date. The new date will be approved and announced not less than 30 days after the date on which the request was received.

At less than 90 days before the calendar date, the date cannot be changed. The event will be cancelled or run as an ordinary event, but no part of the calendar fee will be refunded.

Cancellation: if the title or the event is cancelled 90 days or more before the calendar date, 50 % of the inscription fee will be refunded. In a later cancellation there will be no refunding. A cancelled title will be treated like a title not yet requested.

If the titled event is cancelled less than 30 days before the calendar date, the National Authority may not be allowed to organise a titled event the following year.

Ordinary events

Late request: the inscription fee will be raised by 25%.

Change of date: the inscription fee will be raised by 25%.

Cancellation: If the event is cancelled 30 days or more before the calendar date, 50% of the inscription fee will be refunded. In later cancellations there will be no refunding.

102 - U.I.M. COMMISSIONER

102.01 - GENERAL

The presence of a U.I.M. Commissioner is required at any international titled meeting. For F1, two Commissioners are required.

The function of Commissioner must be fulfilled most carefully.

As soon as U.I.M. gets the Commissioner's agreement, the Secretary General of the U.I.M. will send a letter to the National Authority informing them that the Commissioner has been designated for the events referred in the letter.

No commissioner will be appointed to an event organised by his National Authority.

The U.I.M. Commissioner sent to the competitions must come from a Nation near to the organising one and not from different continents.

National Authorities are requested to send yearly to the U.I.M. Secretariat a list of candidate Commissioners with the following data:

- Name, address, telephone, telefax and/or e-mail
- languages spoken
- languages read and understood
- at what times the candidate is at disposal
- knowledge in sports and technical matters.

102.02 - FUNCTIONS

The U.I.M. Commissioner

- assists the local organiser and more particularly the Officer of the Day;
- is a voting member of the international jury;
- approves last minute amendments to the advance-programme;
- ensure that the course is in accordance with the water registration;
- takes part in important decision-making during the race with the Officer of the Day, the Deputy OOD and the 2nd Commissioner, if any;

- takes part in urgent decision-making with the Officer of the Day and the organising promoter, in matters related to the overall organisation.

The U.I.M. Commissioner is entitled to take action with the race organising committee if safety conditions are not met. In some cases, he will even be entitled to request that the event be suspended if safety conditions are not improved.

The legality of the fuel is solely under the judgement of the U.I.M. Commissioner, based on all tests available to him.

GUIDELINES for U.I.M. Commissioners

- The commissioner must always be aware that he is the sole representative of U.I.M.

On the day prior to the first race/practise day, a meeting shall be held between the U.I.M. Commissioner and the race organisers/officials, and the promoter (if any) to review all aspects of the race organisation. Time for the meeting will be at 18.00, unless otherwise agreed.

The commissioner should also ask for

- * programme
- * list of jury members and National Authority delegates
- * list of entries with names and nationalities.

- He must meet the OOD and Jury President.
- He must assist the OOD to resolve all race problems.
- He must be present at any driver's meeting.
- He must check and approve the race course to comply with U.I.M. and the advance regulations.
- During the meeting he must keep close contact with OOD and be satisfied that everything is being done correctly according to U.I.M. rules.
- He must ensure a Jury meeting is held promptly and any penalty is imposed according to U.I.M. rules.

- In case of an accident, he must keep all the information on the progress or otherwise of the injured persons and he must send completed U.I.M. accident report form to U.I.M. as soon as possible.
- The Commissioner is a full member of the Jury.
- After completion of the races, he must receive a copy of all classifications and documents to be transferred to U.I.M.
- He should be present at the Technical Inspection of the winning boat.
- He must survey the weighing of the boats (if applicable).
- He must be present at the prize giving.

102.03 - AFTER THE RACE

After the event, he sends his report to the U.I.M. Secretariat by using the official form, within ten days after the race. The official results of the event must be enclosed with the report.

The reports from Commissioners are to be considered as confidential matter and cannot be used for aims other than U.I.M.'s, not be communicated to the press or otherwise disclosed for any purpose whatsoever.

Should any Commissioner fail to obtain all necessary data and results for transmission to U.I.M., he will note this fact in his report and will urge the organisers to send all required documents by themselves to the Secretariat of U.I.M., as soon as possible.

A copy of the Commissioner's report will be sent, as soon as possible, by the U.I.M. office to the President of Sport/Technical/Safety Commissions, all members of Cominsport and to the NA of the organiser.

102.04 - ACCOMMODATION AND TRAVEL EXPENSES

The National Authority must remind the organisers that the Commissioner must be accommodated in a good hotel for the whole duration of the event and as long as required by the accomplishment of his mission. The costs of such accommodation are borne by the organisers.

Travel expenses must be compensated by the organisers to the Commissioner from his place of residence to the race venue, calculated upon the basis of a return air ticket, economy class.

If the organisers do not offer daily meals and local transportation to the Commissioner, they must pay him/her up to 30 € per day.

No other costs are to be reimbursed to the Commissioner unless expressly agreed between the organisers and the Commissioner.

Reimbursement shall be done by the organisers directly to the Commissioner prior to departure. If the organisers fail to do so, the Commissioner shall invoice the U.I.M. The U.I.M. then sends the organisers' National Authority an equivalent invoice, adding a 10% surcharge. The invoice must be settled to the U.I.M. within 30 days.

103 - RACES RECOGNISED BY THE U.I.M.

The U.I.M. recognises the following events:

- Titled international events
- Ordinary international events
- International cruises
- National events
- Private or club events

104 - NON APPROVED RACES

Races not organised according to U.I.M. rules are not to be recognised and all officials and drivers who take any part in such races are suspended or excluded if offence recurs.

The same applies to motorboating events not approved by National Authorities.

Any driver having competed in a race not approved by the National Authority of that country or forbidden by the National Authority may be suspended for a period to be fixed by the National Authority.

In the case of an international meeting being organised by a non-affiliated club which has not asked permission to organise such a meeting, the National Authority must:

- notify the organising club that the drivers can be suspended.
- notify the drivers that they will be suspended in their own country if they take part in international races not approved by the National Authority; the latter may request U.I.M. to extend this suspension to other countries.

A national race, or a race by "invitation" in which a foreign driver is invited to take part must be entered on the U.I.M. Calendar otherwise it becomes an unauthorised event. Invited drivers entering such unauthorised races, may lose their international licences. Remember that drivers having international licences, are only allowed to enter a meeting outside their country provided their National Authority gives them permission to do so.

105 - TITLED INTERNATIONAL EVENTS

There are five categories of titled event:

- World Championship events
- World Cup events
- Continental Championship events
- Continental Cup events

- Grand Prix events

There can be one World Cup and Continental Cup event per class and per year, provided that a World or Continental Championship is not organised for the class in question.

There can be only one Grand Prix event per country and per year, except when a World Championship series race takes place in that country

Additional classification, title and awards for low emission entrants within all classes S, T, P, PR and F4 titled events. Same classes must race together to qualify for these UIM titles. A minimum number of starters must be 3. The intent is to award UIM titles to only low emission engine competitors, when the results of the classification of a titled event results in more than 50 % low emission engines. Implementation will only be in that class and will only commence one year later. (i.e. + 50 % 2006 then ALL low emission engines in 2008).

No meeting is allowed a title unless authorised to do so by the U.I.M. who draw up the annual list in the official calendar.

Except for Formula Future, if a scheduled UIM titled event takes place with only 5 or less participating boats from less than 2 National Authorities only the event results will stand. It will not be officially recognised by the UIM and therefore not included in the UIM records. The organiser has the discretion to pay any prize and/or travel/start monies. The organizer will receive a credit of 50 % of the calendar fee.

In "O" series classes (125 to 700) organisers are encouraged to hold two or three titled races at one event by reduction of the calendar fees (rule 101.01). The UIM will look favourably to National Authorities organising these races when allocating UIM titles. The UIM still accepts single title events.

U.I.M. aims to protect titled meetings, the Council may refuse to sanction any meeting which takes place at the same time. Such refusal is only notified at the specific request of the National Authority lodging a protest.

106 - INTERNATIONAL CHAMPIONSHIPS, WORLD AND CONTINENTAL CUPS

106.01- GENERAL RULES

World Championships are open to all U.I.M. classes as well as all A.P.B.A. classes. There can be only one World Championship per class, per year. The requests to organise these championship must be sent in due time. The Sports Commission will allocate the Championships.

No exception is to be allowed to the proceeding rule.

U.I.M. has created Formula World Championships for the F1, F2000, F500 and Formula European Championships for F4, and F250, F1000, Formula R 1000, F125 and F350. All to be run as a series.

Classes O125 to O700 UIM World and Continental championships, these events will only be granted permission on a venue within the group of UIM venue listings (from 2007).

MINIMUM criteria for UIM race Course/Venues:

ONLY for allocation of classes "O" up to O700

The following are mandatory:

- 1) Minimum number of boats registered to be raced at one time: 14
- 2) No clock start
- 3) Correct length and width of jetty. Must be very stable to take relevant boats for safe launching.
- 4) Organisation to guarantee:
 - a) Full medical rescue as UIM rules
 - b) Full experienced organisation to UIM rules
 - c) Computerised timing equipment and experienced staff
 - d) Adequately controlled pit area on hard surface
 - e) Adequate toilets and showers (hot)

Other points to be added on experience.

The U.I.M. delivers following requests made by the champions to their National Authorities and transmitted by that National Authority to the U.I.M. Secretariat a "champion's certificate".

The cost of such certificate is fixed annually by the General Assembly and is to be paid by the National Authority to the U.I.M. when the request is made.

A list of champions is issued annually.

The U.I.M. rules and those of the National Authority are applicable for any point not foreseen by these rules.

A non-European may be proclaimed European Champion provided he has had a European licence for more than two years. The same applies for other continents.

A non-European driver can only compete in any UIM European titled event if:

- a) It is a series
- b) He/she competes on equal terms for any start/prize monies and/or event trophies
- c) He will not accumulate points for the Series
- d) His results will be discounted when calculating points to go forward to the final series point count.

Immediately after the Championship, the name of the Champion must be transmitted by fax and/or e-mail to the U.I.M. secretariat.

The entry for the drivers is free of charge.

106.02 - WATER REGISTRATION

Permission to organise an International Meeting is granted ONLY if the race is run on a course approved by the National Authority and registered by the U.I.M.

All the National Authorities MUST approve such courses and send a list (updated every four years) to the U.I.M. Every list must include ALL the following criteria in English:

A PLAN to scale (1:500 ... 1:2 000) with graphic scale representation and geographical north, showing accurately:

- a) The minimum depth of the race course
- b) Position of ALL race buoys
- c) Position of finish line
- d) Position of jetty/beach (if applicable) or start line
- e) Direction of the race course
- f) Other obstructions duly marked
- g) Any other buoys not applicable to the race
- h) Position of control
- i) Entry to water... crane/slipway
- j) Area for pits
- k) Spectator barriers etc. (see drawing)
- l) Position of ambulance and CLEAR access
- m) An ALTERNATIVE race course (if possible) only for use under "Force Majeure" conditions.
- n) Altitude of venues.
- o) Coloured photographs of the surrounding area (banks, sea walls and others)
- p) Tides chart of the relevant race days
- q) Categories to race
- r) Number of boats of each class/category to race

List of all possible Classes allowed to race. List MAXIMUM number of boats allowed to race in each class.

For circuit races, bridges in the circuit should be avoided. If unavoidable, minimum opening clearances must be 50 m width for hydros, 80 m width for other classes and 15 m vertical clearance, except for endurance races.

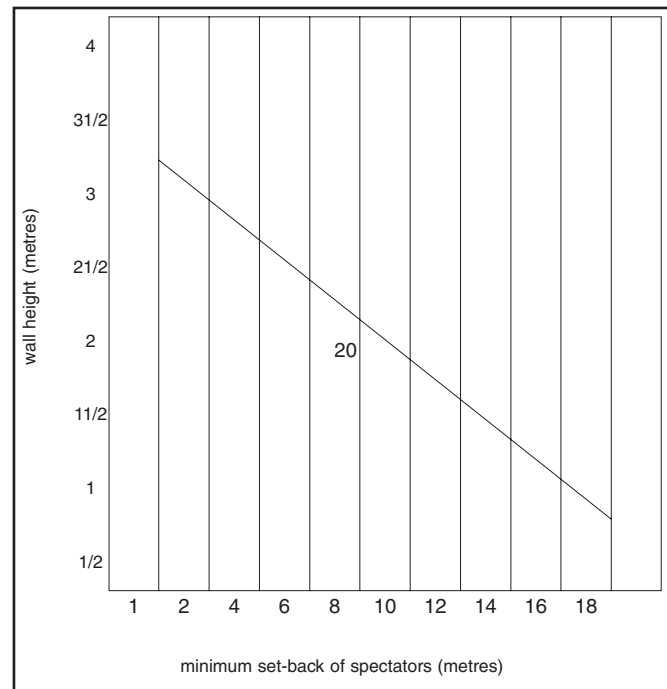

107 - WORLD CHAMPIONSHIP

World Championships, allocated by the U.I.M. Sports Commission are raced under the same rules as the Continental Championships.

To avoid any confusion about the value of the title, there will be no class World Championship when such Championship is organised under the Formula system.

QUESTIONNAIRE FOR WATER REGISTRATION – ARTICLE 106.02

This request will only be considered valid if a plan to scale is added with all details as requested under rule 106.02.

Please provide : A plan in two-fold of the venue with graphic scale – A3 color copy – photographs of the banks and or others of interest by February 28th the latest or 90 days prior to the race.

Please refer also to rules 106.01, 302.01, 307.01, 307.02, 313.03 and those on the blue pages section of the “UIM Circuit Rules” book when applicable.

COUNTRY :

PLACE :

NATURE OF WATER :

TOTAL LENGTH OF CIRCUIT :

NUMBER OF BUOYS :

DESCRIPTION OF TURNING BUOYS :

MINIMUM DEPTH OF CIRCUIT : Jetty *Race course :*

MINIMUM WIDTH OF RACE COURSE :

HEIGHT OF THE BANKS :

ENTRY TO WATER :

PLACE AVAILABLE FOR PUBLIC :

PROTECTION OF PUBLIC :

ALTITUDE OF VENUE :

CATEGORIES TO RACE :

NUMBER OF BOATS TO RACE :

N.A. STAMP

Registered on :

U.I.M. STAMP

Registered for :

Registration n° :

108 - CONTINENTAL AND WORLD CHAMPIONSHIPS

108.01 - NUMBER OF CHAMPIONSHIPS

There can be one championship per year, per class, per continent (except where there is a series) but only in classes approved by the Sports Commission at least 13 months before the applicable year.

The right to organise Continental and World Championships is annually rotated in alphabetical order of the Initials of the English names of the affiliated countries applying.

If a nation declines to organise a championship the next in rotation is taken into consideration.

If a country is allocated a UIM title for a certain year but fails to organise it, this country is considered as having held the championship as far as rotation is concerned.

108.02 - EUROPEAN CHAMPIONSHIP SERIES

European Championships is a series in the following classes:

– O 125 Formula 125 (up to 4 races series)

– O 250 Formula 250 (up to 4 races series)

– O 350 Formula 350 (up to 3 races series)

– FR 1000 Formula R 1000 (up to 4 races series)

– **P750** **P750 Series**

– **OSY 400** **Formula OSY. (up to 3 races series) As from 2008 onwards**

No more than two events of the same series to be held in the same National Authority, unless the full series is not requested.

Each leg of the Championships should be run in accordance to U.I.M. 108 rule.

Classification: In order to obtain a general classification of the European Championship, the first driver classified will be given points as follows: 20/17/15 ... (see F500 - rule 3)

If there any dispute of how the above rule, guidance should be taken from:

- 1) the F500 rules
- 2) the U.I.M. ordinary rules

U.I.M. will provide medals for 1-2-3 in the series at the final race.

Foreign drivers: Those drivers who successfully start in either a qualifying heat & race must receive the following money:

Formula R1000	Euros 100
Formula 250	Euros 160
Formula 125	Euros 160
Formula 350	Euros 160

Formula OSY. Euros 100 As from 2008 onwards

If a driver participates in more than one class at a multi-series event, the organisers has the option of only paying for one entry, if mentioned in the advance program.

108.03 - ENTRIES

Each National Authority may designate drivers according to its own rules.

Entries are to be sent through their National Authority to the organiser, no later than 10 days, before the start of the meeting. Failure to meet this deadline may result in the driver losing any scheduled start money.

108.04 - HEATS AND LENGTH

A championship can only be held during an International meeting. The race must include four heats. Every heat must have a length of:

6 to 8 km for the class OSY 400, OSY R, JT 250, T250, O 125, O 175

12 to 17 km for racing outboards 250cc to 700 cc
for in boards up to 1000cc
for all classes in S.P.T. up to 550 cc

20 to 30 km for racing outboards 850 cc to ∞

20 to 25 km for all other classes

With interval of at least one hour. Between finish of one heat and the start of the following one.

108.05 - REPAIRS AND MEASURING

Repairs are permitted. The substitution of parts (except crankcase) is permitted but must be done under supervision of a technical officer. In those classes where the engine(s) or motor(s) are restricted, such substitution is only to be effected with original parts. Should it be necessary to effect the repairs outside the controlled area, this must be done under supervision of a technical officer.

In multi-heat races a complete engine change is possible: then if it is before time trials no penalty. If after time trials, start low end of jetty. If after first heat or more, all points gained are removed. Start next heat with zero points.

After the race, the first classified boat and engine must be measured by the Technical Officer. A sufficient number of boats must stay in the "parc fermé" until the winner is established.

108.06 - RESULTS

A driver's three best heats are considered for the results.

When through force majeure (bad weather etc.) the heats are reduced in number or length the final positions are a valid race result.

All classes must race separately even if they belong to the same series.

The races for the Championships are not to be combined with races for other cups or trophies bearing another name.

The organising club will present a gold – silver – bronze medal to the top three drivers, unless UIM distributes the medals (to World Championships and to Formula European Championships).

Other prizes may be awarded.

A driver who has entered for a Continental Championship cannot be compelled to enter other races programmed during the meeting.

As soon as the results have been verified, the National Authority forwards these results to the U.I.M. Secretariat.

The results must be printed or typed. The results must include position, name of driver, country, time/laps and points. Additional information such as sponsor, boat may be mentioned.

If a low emission certified engine is raced, the engine manufacturer, complete with engine model number must be mentioned in the full results and on the commissioner's report.

109 - ENDURANCE RACES

109.01 - DEFINITIONS

An endurance trial is raced for at least one hour.

All U.I.M. recognised classes and those admitted by the organising committee are allowed to start together. A separate classification is made for each class, general classification not being allowed.

A general classification of "index of performance" may be included.

The classification is done according to the greatest distance covered by each competitor in his class between the start and the finishing time.

To be classified, the competitors must cross the finishing line and have achieved at least 40 % of the distance covered by the first of the category.

Competitors, still on the course after the finishing time, must finish their lap in order to benefit from the fraction of the distance covered over and above the finishing time.

It is recommended that, for ease of timing, the length of the circuit be calculated in relation to the number of competitors (40 meters per entrant).

The above rules notwithstanding, certain experimental and unclassified boats may take part in endurance trials, but they must be scrutinised by technical officers before being allowed to race. They are not to be considered for prizes or classified.

110 - ENDURANCE CHAMPIONSHIP

110.01 - DEFINITIONS

To be taken into consideration for these championships, a trial must be raced for 3 hours total, raced in 1 or 2 heats of equal duration. In this case, an interval of one hour minimum and a maximum of 24 hours must be allowed between the starts of the heats.

If the trial lasts longer than 3 hours, more than, one driver must be used per boat, each member of the team gets the number of points provided for by the classification of the team. Each driver of the team has to be appointed before the start and no later change will be authorised.

The number of drivers for each team authorised to take part in a trial will be fixed by the Sports Commission in the calendar.

For this championship, 6 trials maximum and 4 trials minimum held in various countries will have to be organised if these figures are not reached, the title will not be granted.

The general classification of a trial will give the drivers the points set out in article 318.01 (1r/400, 2nd/300, etc...). To be classified, a boat must have covered more than 50% of the distance of the winner.

Granting of the title will be made taking into account the best results of each driver, according to the following table:

6 or 5 organised trials: 4 results

4 organised trials: 3 results

In case of a dead-heat for the first place, the best additional classification obtained from the series will be taken into consideration.

Requests for entry are to be sent in conformity with the rules (article 101.03).

Entry fees are the same as those requested for circuit championships.

The advance-programme of endurance championships must show clearly the starting system which will be used.

The boats belonging to class racing outboard unlimited are not allowed to start in races for endurance championship races with class racing outboards 2000 cc.

111 - HANDICAP

Handicapping is only allowed for private or local meetings and for invitation races. Handicaps must be published by the race committee and communicated to all the drivers before the start.

112 - RULES FOR DRAG RACES

112.01 - DEFINITIONS

The word "DRAG RACING", defines a particular kind of racing which originated in the United States and is derived from the slang of American mechanics.

First practised in motor racing, drag racing has now been adopted by motorboat racing enthusiasts.

World records of the different U.I.M. series and classes as well as those of the American Power Boat Association, drag records included, can be homologated by the U.I.M.

The racing regulations of the U.I.M. apply for any point not mentioned in the rules issued annually in the American Power Boat Association Year Book (part. 1 Racing Rules) Year Book, volume 1, Racing Rules).

120 - RACING LICENCES

120.01 - COMPULSORY LICENCE

No one can take part in a U.I.M. race, establish or improve on a U.I.M. record in international class boats, without being in possession of an international licence from his National Authority.

In order to obtain an International licence or Super Licence, following disclaimer must be signed by the licence holder:

"The undersigned... Licensed pilot (licence n), participating to U.I.M. sanctioned events, yields the media rights of any coverage by the promoter taken during the event, to the U.I.M. for further use by press, radio or television. The right however remains the property of the undersigned"

120.02 - REGISTRATION

The National Authority establishes each year a list of people to whom licences have been delivered and this is sent to the U.I.M. Secretariat.

The list must include: the name and surname, the address, the class(es) and whether National or International Licence.

These lists may be sent to other National Authorities.

Licence numbers are given annually by the National Authority to the owners and drivers entered on the list.

Any person wishing to obtain a licence must apply to the National Authority through his club.

The licence is granted by the National Authority and is marked “International” as decided by the National Authority. Licence holders must have a U.I.M. rule book. For international endurance races, titled or not titled, only one example of the UIM rules will be required, one per boat and not per each pilot.

Any National Authority has the right to deliver licences to:

- its nationals
- nationals of another country affiliated to the U.I.M. only with the agreement of the National Authority of that nation.

With the approval of the U.I.M. a National Authority may also deliver licences to persons belonging to a country which is not yet affiliated to the Union.

Drivers are only permitted to hold licences from one National Authority.

A National Authority may refuse to give a licence. Notification of this is sent to all affiliated clubs and to the U.I.M.

120.03 - VALIDITY OF LICENCES

Licences are valid from the 1st of January until the 31 st of December each year, unless local circumstances require other dates, but validity should always be shown on the licence itself, and must be for one year.

A licence is valid in any country affiliated to the Union and entitles the holder to enter or drive in his boat in all competitions organised in any affiliated country, provided he complies with what is stated in the U.I.M. general racing rules.

However, for any event held under special rules, the licence holder must abide by the rules in question.

120.04 - COST OF LICENCE

The cost of the yearly licence is to be fixed by the National Authority.

120.05 - EXAMINATION OF LICENCES

At any meeting, the holder must produce his licence at the request of any official of the meeting.

120.06 - CANCELLATION OF LICENCE

Anybody who takes part in an unauthorised meeting loses his licence.

However, if the unauthorised meeting is held in waters of a country other than the one which has delivered the licence, both National Authorities must agree as to the duration of the suspension. The U.I.M. decides finally in case of dispute.

120.07 - PSEUDONYM

The use of a pseudonym must be requested to the National Authority and the National Authority marks the pseudonym on the licence.

A licence holder, as long as he is listed under a pseudonym, may not take part in any sports event under any other name.

Changing a pseudonym is subject to the same formalities as the adoption of it. Anyone who has chosen a pseudonym may not return to his actual name until the National Authority has agreed and has delivered a new licence.

The driver may only race under his name or the pseudonym written on the licence.

120.08 - SUPER-LICENCE ENDORSEMENT FOR WORLD FORMULA SERIES RACING

120.08.01 The superlicence is required for Formula 1, and F2000.

- 120.08.02** Before being granted a superlicence, drivers must have taken part in 10 circuit races for class S catamarans equipped with an engine of a capacity higher than 750 cc, or in three races for class O boat with an engine of a capacity 500 cc or higher. Updates rules see blue pages.
- 120.08.03** The application for a superlicence must be lodged to the U.I.M. 4 weeks before the date of the meetings in which the driver plans to participate. The super licence fee of 120 € will be doubled if application is after the four week deadline.

Enclosed with the application, there must be:

- the driver's sports résumé, with the results obtained at the qualifying events (120.08.02);
- an immersion certificate (205.05)
- two passport size photos
- a U.I.M. medical certificate providing all the data required by U.I.M. rules;
- the amount of fees fixed by the General Assembly.

A current rule book will be given to the licence holder together with the super licence.

The National Authorities are responsible for the information given. The superlicence application will be examined by the Secretariat of U.I.M., with the assistance of the F1/Formulae Committee. They will be free to decide upon possible waivers.

1. Any new driver must be vetted during practise by the O.O.D., the U.I.M. Commissioner and the drivers representative.
2. A new super-licence is provisional for the first 3 races, and can be withdrawn at any of the first 3 races by a committee composed by the O.O.D., the U.I.M. Commissioner and the drivers representative. The withdrawal cannot be protested or appealed.

Suspension for any circumstances may be made by the Formulae (1) committee.

When a superlicence is withdrawn, a re-application can only take place for the next season.

- 120.08.04** The superlicence is valid for one year (as from the 1st of January or the date of delivery to the 31st of December of the same year). Each year, the National Authorities concerned will have to send to U.I.M., before the end of December, the list of drivers asking to renew their licence. As to new licences, see 120.08.03.
- 120.08.05** In F125, F250, F350, F500, F1000, FR1000, Formula OSY and F4, there is no superlicence but National Authorities will have to send to U.I.M. before the end of February the list of drivers racing in these categories and formulas, with their addresses.
- 120.08.06** The Secretariat of U.I.M. will hold all the information referred to in 120.08.05 as soon as it is received.

200 - RACE ORGANISATION

200.01 - GENERAL

The following bodies have the right to organise any motor-boating event: National Authorities; Affiliated Clubs; Corresponding members of the U.I.M. contracted promoters (with the agreement of the National Authority).

All events have to be sanctioned by the National Authority.

Affiliation to the National Authority implies their acceptance of the national rules and those of the U.I.M.

A club, member or driver who is suspended, is not allowed to take part in any sporting event in his country or in any other country neither as a driver nor as an official, as long as the suspension lasts.

A member or a driver who takes part in any race in a foreign country affiliated to the U.I.M. is ipso facto under the jurisdiction of the National Authority of that country.

A member or a driver belonging to a country which is not affiliated, is to be considered as a national of the country where he takes part in a race.

All clubs, race organisers, officials and drivers are obliged to know the general rules of the U.I.M. as well as the rules related to races or series (local, national or international). Two copies of the present U.I.M. rulebook and up to date amendments must be available at every race.

All races organised by the National Authorities or their clubs are subject to the U.I.M. racing rules. All rules and programmes must mention this.

The general racing rules and the rules related to records are applicable to all the international series.

200.02 - INTERPRETATION OF THE RULES

In case of conflicting rules, those rules concerning series and classes are to prevail over the general rules.

In all cases not foreseen by the International rules or seemingly inaccurately defined, the National Authority, a race committee, race jury or an appeal board, is to judge bearing in mind the intention of the disputed rule.

201 - ORGANISING BODIES

201.01 - RACE COMMITTEE

All races are under control of the organising club who is to nominate:

- An Organising Committee which organises the general and administrative aspects of the meeting;
- A Race Committee which organises and supervises the actual racing and decides whether competitors are eligible or not.

The Race Committee is composed as follows: the Officer of the Day, the Deputy Officer of the day, the Medical Officer, the Race Secretary, the Technical Officers.

The decisions of the Race Committee and the Jury must be based upon the U.I.M. rules, but as no rules can be devised capable of covering every case, the race committee should discourage all attempts to win by means other than fair racing, superior speed and skill.

The organising committee appoints a Committee that verifies all the documents required i.e. Measurement Certificates, Driving Licence, etc. This Committee also verifies whether or not the boats and motors conform to the rules.

No officer, nor member of the Jury, nor member of a National or International Committee or Commission, is allowed to intervene in the judgement of a problem in which he is involved himself or is an interested party.

The following are the Race Officials:

1. The Officer of the Day;
2. The Deputy Officer of the day;

3. The Medical Officer;
4. The Secretary of the Race Committee;
5. The Technical Officers;
6. The Course and Buoy Officers;
7. The Timekeepers;
8. The Lap Scorers;

201.02 - INTERNATIONAL OFFICERS LISTS

- Lists of International Officers of the days and of International Jury Chairman are deposited in the Secretariat of the U.I.M.
- Every year, each National Authority has to transmit the Secretariat its new list of O.O.D. and I.J.C. or the confirmation of the previous year's one not later than September 30th.
- Each National Authority may propose for enrolment in the list of O.O.D. and I.J.C. only those race Officers that have been regularly qualified by said National Authority.
- Requirements for the enrolment of a candidate:
 - a) a personal record (containing personal data, address, telephone, fax, numbers and/or e-mail)
 - b) knowledge of French or English
 - c) not less than a five year experience in the position applied for
- Only people enrolled in the U.I.M. lists are allowed to be appointed to the charges mentioned above and therefore to be appointed by their National Authority to perform such duties in international races valid for U.I.M. titles.

201.03 - THE OFFICER OF THE DAY (OOD)

The Officer of the Day must supervise the organisation of the races on behalf of the Organising Club. He must maintain order on the course, ascertain that all services work properly, ensure that all correspond to the rules and observe the Racing Rules according to the Programme, gather written reports of the Officers and Timekeepers and any other documents that will enable the results to be compiled.

201.04 - THE DEPUTY OFFICER OF THE DAY

The Deputy Officer of the day co-ordinates (together with the Officer of the day) the safety services on shore (fire) as well as on the water (boats, people on board, material). When necessary he stands in for the Officer of the day.

201.04.01 - THE MEDICAL OFFICER

The Medical Officer is responsible for the medical organisation in the racing area, on shore as well as on the water.

In agreement with the Officer of the day and his deputy, he controls the order of the means of emergency such as life-boats, ambulances, mobile reanimation unit, an eventual airborne ambulance and the first aid station.

In case of intervention on the water, he will take command of the rescue operation following stopping of the race by the Officer of the day.

201.05 - THE RACE SECRETARY

The Race Secretary is responsible on behalf of the O.O.D. for the practical side of the meeting and organisation and must satisfy himself that the various officials know their respective duties and that they have all the necessary documents and equipment. He must collect all documents.

201.06 - DUTIES OF THE RACE OFFICIALS

The Race Officials shall perform only the duties with which they are entrusted.

201.07 - THE TECHNICAL OFFICERS

The Technical Officers are to make sure that all drivers have their Measurement Certificates and shall verify that the hull and engine conform to the certificate and rules, and make sure that the drivers carry the homologation sheets of the engines or hulls used.

They check and control safety devices for boats and drivers as provided for in the rules.

Special attention must be paid to the automatic engine shut-off and that the racing number conform with the rules.

They verify the synchronisation of the clock and the camera if used.

After the race, they must do all necessary checks, all infringement must be communicated in writing to the O.O.D.

201.08 - THE BUOY AND COURSE OFFICERS

They must ensure that the drivers conform to the racing rules. Any irregularities must immediately be reported to the O.O.D. by radio, and in writing following the event, the O.O.D. will enforce the rules when needed. Buoy and course officials are allowed to be in boats. If they cannot be in boats inside the circuit, there will be two of them: one at the entrance and one at the exit of each turn.

201.09 - THE TIMEKEEPERS AND STARTER

The Timekeepers will:

- calculate on completion the elapsed time of each drivers;
- establish the finishing order after having made all necessary calculations and establish the average speeds;

- for international races there must be at least two timekeepers. Their results must only be handed to the Officer of the Day;
- the starter signals the start when ordered to do so by the Officer of the Day.

202 - ADVANCE-PROGRAMME

202.01 - FORWARDING DATE

45 days before any international race the organising committee must forward at least one advance-programme to the U.I.M. Secretariat, to the National Authorities and to the invited Clubs and drivers. The advance-program will also be forwarded to the commissioners for recommendations. Any such recommendation should be accomplished at least two weeks prior to the event.

Should the 45 days delay not be complied with, the calendar fee will be double.

The above advance-programme must be written in the language of the organising country and in English and must contain the following information:

- 202.020** the name and the address of the organiser;
- 202.021** the series and classes of boats catered for;
- 202.022** the race or races which will be run;
- 202.023** the venue and the date of the race(s);
- 202.024** the course of each race and plan drawn to scale showing all details as per rule 106.02. Start method, flying start or dead engine start, and maximum numbers of boats on the course.

The spectator areas must be shown and minimum distances between spectator areas and the course marked on the plan. Natural or man-made spectator protection such as fences, docks, etc. shall be noted.

The circuit plan and spectator areas shall be positioned to provide for spectators and drivers safety. Spectators and crews shall not be in the water during the running of a race.

- 202.025** The races are held under the U.I.M. rules;
- 202.026** The special conditions which in accordance with the U.I.M. rules may be added or modified;
- 202.027** Time limit and place to which entries must be sent, and whether written, by fax or by hand;
- 202.028** The amount of the entrance fee, except for Continental or World Championships for which there is no fee;
- 202.029** All information regarding the prizes for each race;
- 202.030** An entry form must be included in the advance programme. Where and when racing instructions can be obtained;
- 202.031** Transport facilities and concessions;
- 202.032** - Terms and conditions of a mandatory insurance for personal and material damage to third parties, competitors included;
- The minimum limit of coverages required;
 - The quality of risks to be covered by the insurance;
 - Whether insurances from other National Authorities are authorised and if they are, in which language they must be drawn up;
 - The amount of insurance fees to be paid on the spot (90€ maximum).
 - If the charge to the drivers for the insurance exceeds 90 euros, the UIM will fine the organising National Authority with twice the amount exceeding 90 euros per driver that they have had to pay the extra insurance.

- UIM will then return only the extra insurance fee to each drivers National Authority.

- 202.033** Minimum age of competitors;
- 202.034** Times for practice per class and the interval between the heats;
- 202.035** Full instructions regarding noise regulations;
- 202.036** Date and times for scrutineering;
- 202.037** Should no publicity be allowed during a race, this is to be mentioned in the advance-programme;
- 202.038** The time limits for late starters and finishers;
- 202.039** No modifications are to be made to any particular rule after the advance-programme is posted except if decided by the Race Committee and for cases of force majeure only. The modifications must be communicated, by written means, to the officials and participants, at least 1 hour before the first start.
- 202.040** Place and time of the drivers meeting.
- 202.041** The protest fee. (maximum 80 euro)
- 202.042** Organisers must announce if they will supply fuel at the meeting, at what price, and to what manufacturing specification and octane rating.
- 202.043** There should not be any financial penalty for not respecting any UIM rules other than what is provided in the UIM rulebook.

203 - ENTRIES

203.01 - RATIFICATION

The National Authorities must ratify in writing any entry for drivers wishing to race abroad.

Direct correspondence between the organising committee and foreign drivers is permitted but no entry is to be accepted unless approved by the driver's National Authority.

The Organising Committee will keep blank entry forms at the disposal of the drivers.

An entry is not valid unless it reaches the organising committee within the time prescribed in the advance programme.

203.02 - ADMISSION

No organiser, organising an international race has the right to refuse the entry of a foreign driver duly commissioned by his own National Authority provided said driver conforms to U.I.M. rules.

Drivers need only to supply such particulars as are applicable to the class of their boat.

However, if a driver wishes to enter a boat with a reinforced cockpit (rule 509) in a class where a reinforced cockpit is not mandatory he must mention this in his entry. Acceptance of the entry then binds the organiser to provide the proper rescue facilities as per rule 205.08.

No entry shall be considered accepted until the boat has passed scrutineering and the documents are checked.

Only one boat per driver is allowed to be entered for any championship meeting. Spare hulls and engines are allowed but may only be used as foreseen in the rules.

203.03 - ENTRY FEE

Each organising committee fixes the amount of entry fee for the races. Entry is valid only after payment of the entry fee.

The National Authorities have the right to establish a rule whereby higher fees are imposed on late entries.

203.04 - MINIMUM AGE

Each National Authority has the right to fix a minimum age for the drivers allowed to race on its waters. Such age restriction is to be shown in the advance programme.

203.041 - MINIMUM AGE INTERNATIONAL

The minimum age for all drivers racing international races is 16 years. For racing in the classes S-P-T up to 400cc and OSY «R» the minimum age is 14 years.

Drivers allowed to race in the class JT250 must be 10 years of age (by the race date) and may complete the race season in which they reach 16 years of age.

Minimum age of drivers allowed to race in class Formula Future is listed under 500.10 pt 1.1.

203.05 - NATIONALITY

The nationality of only the driver must be taken into consideration in the classification.

203.051 - PUBLICITY ON THE BOATS

Advertisements may be freely applied on the entire surface of the boat, but there must be a free distance of space of no less than 0,15 meter around the boat number.

No crew can be compelled to carry any advertising whatsoever on their person, clothes or upon the boat that is being raced and his-their refusal to do so cannot in any way be an obstacle to their participation in any race.

Penalties may be applied to any driver who, in the course of any sporting event, has made any advertisement contrary to the truth or distorting the facts.

Political publicity or immoral advertisements are not allowed.

Should no publicity be admitted for an event, this has to be announced in the advance programme.

Any National Authority has the right to fix its own rules regarding publicity for its own boats and courses.

204 - RACE INSTRUCTIONS

204.01

The Organising Committee must clearly state the following points in their race instructions:

- 204.011** Places and dates of the race;
- 204.012** Layout of course drawn to scale:
 - Length of the course;
 - Direction of the course;
 - Starting line and its marks;
 - Finishing line and its marks;
 - Full details of buoys;
 - Full details of obstacles.
 - Prohibited area.
- 204.013** Starting time of each race;
Signals for each race;

- 204.014** Full particulars of prizes for each race;
- 204.015** Time limit and place for handing over the protests;
- 204.016** Time and place of the distribution of prizes;
- 204.017** Composition of the Race Committee, of the Jury and of the Technical Commission;
- 204.018** List of boats entered for each race and if possible, names and clubs of the drivers;
- 204.019** Place and time at which written instructions will be issued. Where and when the official time is to be communicated and place and time of driver's meeting.
- 204.020** Only drivers whose entries have been accepted by the organising committee have their names printed in the programme;

204.02 - ORGANISING COMMITTEE MEETING

On the day prior to the first race/practise day, a meeting shall be held between the U.I.M. Commissioner and the race organisers/officials, and the promoter (if any), to review all aspects of the race organisation. Time for the meeting will be at 18.00, unless not otherwise agreed.

204.03 - DRIVERS MEETING

A driver's meeting must be held before any training.

It is mandatory for all drivers to attend all driver's meetings.

If these meetings are not held in English, a full and immediate translation into English must be made by an interpreter.

It is mandatory to inform the Drivers of all environmental matters at the Drivers meeting (See Group 700).

205 - SAFETY RULES

205.01 - ANNUAL MEDICAL EXAMINATION

Each National Authority must submit all the drivers under its jurisdiction to an annual medical examination.

Each National Authority must adopt a form to be used for the medical examination.

Each National Authority must submit to a special medical examination any handicapped driver, any driver who has had a serious accident or any driver who, during two or three races, has shown odd behaviour when driving his boat: this check is compulsory before participation in any international race and must be certified by a commission set up by the National Authority of the interested driver; the commission will be composed of a well known specialist, a technician and a delegate of the National Authority; the Commission may give or refuse authorisation as to the eligibility of the driver.

Each National Authority which organises an international race must abide by the regulations approved by the Medical Commission regarding the medical organisation of international races.

205.02 - MEDICAL EXAMINATION AT EVENT

The medical officer who is to be present at any motorboating event has the right to submit any participating driver to psycho-physical examination and this at any time during the event, an alcohol or drug test may be performed.

The result of such examination is immediately communicated to the Race Committee who basing themselves on the report of the medical officer, may suspend the driver from the competition.

Following any accident, the driver must undergo a physical examination and be passed fit by the event medical staff before being permitted to continue in that racing event.

Following any accident, damaged boats must be completely rechecked and approved by the official scrutineer and the U.I.M. Commissioner, before being permitted to rejoin the event.

205.02.01 - MEDICAL EXAMINATION - ADDITIONAL REQUIREMENTS

In order to qualify for a superlicence or for drivers in classes where the U.I.M. world speed record exceeds 210 kmh, 131.25 mph (at 1st January of the relevant year), additional items in the medical examination are mandatory.

205.02.02 - DOPING TEST CONSUMPTION OF ALCOHOL

- Competitors shall not be under the influence of alcohol while competing and practising
- Testing when carried out shall be by using an alcometer
- A competitor shall, if requested by an authorised official, submit to an alcohol test. Written notification of selection for testing will be handed to a competitor by an authorised official. Refusal or failure to do so may be taken as if a positive test had been ordered and dealt with accordingly.
 - a. For international races, any competitor found to have more than BAK 0,15 0/00 (0,15 g/L blood // AAK 0,075 mg/L air) 1 hour before and during testing or race shall be immediately suspended and disqualified from the whole event. A format report shall be forwarded to the NA of the competitor.

If in an organising country, the legal requirements of the above numbers are lower, then these numbers have to be announced in the advance regulations and prevail.

205.02.03 - ANTI-DOPING REGULATIONS

Anti-doping regulations based upon the world anti-doping code

As per separate publication

205.03 - MEDICAL EVALUATION SHEET

Established at _____ Date _____
 Name _____ Surname _____
 Born in _____ Date _____
 Address _____
 Status _____ Profession _____
 Date of first involvement in the sport _____
 Other sports practised _____

PRESENT STATE OF HEALTH AND FORMER DISEASES

Disease _____

With special mention of _____

o Cardiopathy o Coronary o Trouble Diabetes

o Epilepsy o High blood pressure

Operations undergone previously _____

Dates of these operations _____

Accidents (when, where, under which circumstances) _____

Alcohol _____ Tobacco _____

Allergies _____

Medicines usually/frequently taken _____

Signature of the interested person _____

205.04 - GENERAL OBJECTIVE EXAMINATION

Height _____ Weight _____

Congenital or acquired deformities _____

Respiratory system _____

Spirometry _____

FVC _____ FEV1 _____

Cardiovascular system _____

Blood pressure _____

Heart frequency at rest _____ after stress _____

Electrocardiogram at rest and after stress (see 205.04.1) _____

Sight-testing a) Faculty of vision _____ R _____ L _____
 with correction _____ R _____ L _____

b) Vision of colours

Hearing testing _____ Rh _____

Urine: Albumine _____ Sugar _____

Nervous system _____

EEG _____ Date _____

Others _____

Signature of the doctor _____

Name in capital letters _____

Degree _____

Address _____

Tel/Fax _____

Aptitude assessment _____

205.04.1 - ADDITIONAL ITEMS FOR SUPER-LICENCE

1 electro cardiogram and stress effort each year

Clinical medical stress test: Electrocardiogram performed under stress in a sitting "position" or on a tread mill starting at 50 watts and increasing by 25 watts every two minutes (or equipment test). The driver must be capable of reaching 2.5 watts (males) – 2.2 watts (females) per kilogram of body weight.

1 exhaustive opthalmological check-up, tested and certified by a professional ophthalmologist to be renewed every five years and after skull trauma

205.05 - IMMERSION TEST

Competitors taking part in a race and using a reinforced cockpit as defined in rule 509, must have a certificate of underwater training. This is given by a National Authority and includes an immersion test in a simulated reinforced cockpit. All tests must include demonstrating the drivers ability to use the air supply successfully under water in simulated accident conditions. The immersion test is only valid for 14 months.

A model for the certificate and instructions of how to perform an immersion test are available at the U.I.M. Secretariat.

205.06 - LIFE JACKET

Each person aboard a race boat must wear an efficient life jacket during the race and practice conforming with the following rules:

The efficiency of a life jacket is the sole responsibility of the wearer who must be assured that it conforms with the U.I.M. rules and carries indelible confirmation of this;

Race organisers are required to repeat this important clause in race instructions and in the advance-programme;

This compulsory regulation is for all international races and recommended for national ones. In any case, life jackets must be in conformity with following rule;

Buoyancy: a life jacket must have a minimum of 7,5 kg solid buoyancy for a person weighing up to 60 kg and 9 kg solid buoyancy for those over 60 kg (closed cells foam only);

The disposition of the solid buoyancy must be such as to ensure that an unconscious person shall float face up in the water;

All adjustable straps must be at least 40 mm wide and have a minimum breaking strain of 1000 kg. The crutch straps must be attached at the front at the position of iliac crest and at the back in the sacral region. A recovering attachment must be placed either on the shoulders, or as a chest strap and made with strap of the same quality as indicated above;

Manufactured from fire resistant material and coloured orange;

The back must include a protective plate;

The compulsory collar must have rounded edges and extend above the bottom of the helmet. It must not exceed 180 degrees;

A racing life jacket manufacturer must undertake to comply with the rules and print indelibly on the life jacket the following : “conforms with the regulation for a person weighing a maximum of 60 kg” or “for a person weighing over 60 kg”, in respect of the buoyancy.

Flotation overalls are a permitted alternative to life jackets, but must conform to all life jacket requirements (colour, buoyancy, protective plates, collar, etc.). The overalls must also include the cut resistant material required in rule 205.11.

205.07 - PROTECTING HELMET

Any person aboard any boat taking part in races must wear an adequate helmet which at least the upper 50 % (Area) must be of fluorescent orange, red, yellow or international orange color. These helmet colors must be bright enough to be clearly visible in the water.

The wearer is entirely responsible for the efficiency of his helmet. The organisers are requested to repeat this important rule in their particular rules, as well as in their advance-programmes, race instructions and programmes.

Each National Authority may request that their nationals wear a helmet of a type laid down in their own national rules.

205.08 - SAFETY BOATS

- 1) The crew of a safety boat should be as follows: one driver, two divers, one doctor or a paramedic who has to be on board at least one boat
- 2) The safety-boat must be in contact by radio with the Officer of the day or the person designated by him
- 3) The safety-boat crew will lift the victims of an accident from the water keeping them in a horizontal position as much as possible, using a rigid stretcher
- 4) It is recommended that one person capable of providing basic life support administration be on board the boat

5) When competitors use safety harnesses, the divers must know how to deal with these systems.

205.08.01 - TOWING BOATS

There must be at least four boats for towing damaged boats on circuits up to 2 000 metres.

Each of these boats must cover 1/4 of the circuit, the space to be controlled being in any case limited to a length not more than 500 linear metres. The towing boat crew will consist of two people. The towing boat must contain the following equipment:

one signal flag, one fire extinguisher of a high capacity homologated for fuel fire, ropes and a boat hook.

Towing boats can only come into action once the race has been completed or stopped.

205.08.02 - FIRST AID STATION

A first aid station with qualified medical must be located within the racing area.

At least one ambulance and one mobile resuscitation unit with a qualified doctor must be located within the racing area.

205.09 - INSURANCE

All drivers must be properly insured, either by themselves, with the policy to be produced before the start, or by an insurance covered by the National Authority, the fee being paid by the driver.

If insurance can or must be bought at the race meeting the total cost must be stated in the advance-programme. The cost to the driver must not exceed 90 €.

Do not underestimate your responsibility in accidents occurring during official trials before the verification of the boats and the various documents required. Only verification will make it possible for you to be sure that the driver is insured properly.

205.10 - TECHNICAL PROTECTION

It is forbidden to start the motor with the propeller rotating in the air, except when the boat is launched immediately.

After launching of a boat whose cylinder capacity is more than 750cc, it is forbidden to start the motor or the engine with the afterpart of the boat lifted up and the screw rotating. If it is necessary in order to start a boat of less than 750cc to lift it up, a contrivance must be set up to protect the person(s) who must launch the boat.

This device must leave a free space between the propeller and the above mentioned people.

205.11 - CLOTHING PROTECTION

It is mandatory that cut resistant clothing "with equivalent properties to" Kevlar 29 fabric be worn by participants in all boats without reinforced cockpits. All limbs of drivers in both reinforced and non-reinforced cockpits must be covered. A one-piece overall suit must be worn in reinforced cockpits.

205.12 - LIFTING OF RACEBOATS

Boats intended to be craned in and out of the water, must have slings and hooks certified to lift minimum the double of the minimum boat weight.

The certification must be located on the slings and the hooks.

All hooks used for lifting raceboats must be a closed hook type.

Lifting eyes on the raceboat must be bolted through the construction of the boat, with minimum 8mm bolts and washers of at least 10 sq.cm pr. lifting points.

No boat shall be lifted over people. Lifting a boat with a person on board other than for weighing will disqualify that boat and it's driver.

No boat can be lifted higher than 0,5 m from the boat's trailer or the ground/water with any person on board, while weighing.

205.13 - TESTING

Testing outside the race circuit and before or after the authorised hours is prohibited during the event.

205.14 - ACCIDENT REVIEW BOARD

At the request of the UIM Commissioner at an event and/or the initiation by the Safety Commission upon receipt of an accident report, an accident review will be held. The Safety and Medical Commission shall oversee and conduct the review. This review may consist of interviews with pertinent and appropriate parties, examination of the relevant racing equipment, review of relevant reports, etc. in order to determine as much useful information as possible. A report of the findings will be filed with UIM and may be used as the basis for rule changes.

206 - NATIONALITY AND RACE NUMBERS

206.01 - NATIONALITY

The national flag, painted in a rectangle 25 cm x 40 cm on the deck, the hood, or the vertical part of the sides: this flag must be visible on both sides of the hull. The national flag should show the nationality of the drivers license.

206.02 - NUMBERS

A race number is allocated to every driver by his National Authority.

Should two drivers of an international competition have the same number:

- 1) the driver of the inviting nation will change his number following the instructions of the Technical officer.
- 2) If none of the drivers is from the organising nation, the driver who entered last will change his number following the instructions of the Technical Officer.

The race number may be fixed:

- 1) on a surface corresponding to the following measures and characteristics: the surface measures 32 x 40 cm and the numbers must be black on a white surface on both sides of the hull in digits of 24 x 14 cm.

The space between the rectangular with the digits must be 4 cm.

The white surface must surround the digits with 4 cm.

All numbers must be plain and upright (no italics). No number shall begin with zero, e.g. for 2 digit numbers (sketch as shown below):

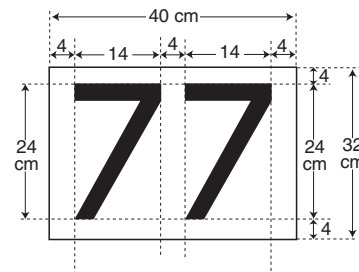

In case of a 3 digit numbers, the length of the surface must be modified consequently.

- 2) the race numbers may also be painted or glued to the slightly curved surfaces and on one vertical surfaces provided that the whole number is within 30 degrees from the vertical position.

It is recommended to use two digits only.

National Flag and the race number must remain visible during the whole race.

206.03 - LOSS OF RACE NUMBER

The absence of the race number or part of that race number leads to the disqualification of that boat.

206.04 - UIM STICKERS

The UIM actual logo, minimum 20 cm in length stickers, ***supplied by the UIM or other manufacturer***, must be attached to both sides on a near vertical surface, of all boats participating in UIM titled events. ***The loss of the UIM logo will not be a reason for disqualification at post race technical inspection.***

RULES FOR CIRCUIT RACES **300 - RULES FOR CIRCUIT RACES**

300.01 - DEFINITIONS

French	English	Italian	German
Course	Race	Gara	Rennen
Manche	Heat	Prove	Lauf
Tour	Lap	Giro	Runde
Circuit	Circuit	Circuito	Rundstrecke
Parcours	Dist. covered	Percorso	Rennstrecke
Base	Base	Base	Messtrecke

Circuit

A circuit is a closed course defined by buoys where races are to be held.

Circuits must be anti-clockwise.

Distance covered:

Distance covered is the total distance to be covered per heat or race.

Base:

A base is a course expressly measured for record attempts.

Marks of the Course:

Any objects specially indicated as such in the race instructions, are to be considered as marks of the course.

Obstacle:

Any non specified object is considered as being an obstacle to free navigation.

Race:

A race is a competition in speed between boats held in one or more heats.

Event:

An event is one or several races held at the same venue and within one, or more days.

Laps:

When calculating percentages of races in any circuit rules: ONLY full completed laps (Rounded up) can be counted.

(eg; 75% when full race is 7 laps = 5.20. Rounded up = 6 laps)

301 - TIMING

In all international races and national championships the timing is carried out by officially appointed timekeepers using certified timing devices graduated to one tenth of a second. The devices must have a split second system one part of which must be capable of being stopped and restarted or any electronic of the same or better accuracy.

302 - CIRCUIT**302.1**

All circuits must be measured on site by official surveyors or measured on an official chart of not less than 1/25 000.

At U.I.M. titled races the length of circuits must be for:

O175 / OSY.400 / OSY «R» – S.T.P.

Classes up to 550 cc Lap of 1000 metres to 1500 metres with maximum of any one straight 600 metres.

All other classes Minimum of 1500 metres, with maximum of 850 metres for any one straight.

The alignment of the start pontoons, or the start line should be such that the pole position has the maximum advantage towards the first turn buoy, compared with the last positions on the starting grid.

If the length of the course cannot be certified, the marks having drifted or for any other reason, the speed is not to be declared in the results (or used in the event of a "dead-heat")

The organisers must ensure that the position of the buoys does not present any danger to the drivers.

It is recommended that the pits be sited where possible away from the race course on the outside.

302.2 - RACE CONTROL

- a) Race control should be situated so that the circuit can be easily seen and controlled;
- b) The race should be observed by three persons:
 - the O.O.D.; or his assistant;
 - one or two Commissioners or one or two members of the Jury;
- c) The O.O.D.; is the general observer of the race, being in radio or telephone contact with the assistant, the Deputy Officer Of the Day and the rescue team;
- d) The other two supervisors share the circuit in observation;
- e) The race can only be stopped by order of the O.O.D.;

303 - MARKS OF THE COURSE**303.01 - DEFINITIONS**

The Marks of the Course are any objects (boat, buoy...) that are specifically designated as such in the racing instructions. The objects that are not designated specifically as such are to be considered as obstacles.

Course turn buoys must be of a single colour of either orange or yellow 70 x 70 cm (28" x 28") except the mark on the starting/finishing line buoy which carries a black and white chequered buoy or a white and black striped buoy.

The safety zone (150 m minimum) is defined by at least one buoy which carries a white and red chequered identification or a white and red striped identification.

The buoys are to be made of rubber or similar material.

An Official is posted near the turning marks. He must observe the turning of the marks and report to the Race Committee.

Should any mark be removed from its proper position either by accident or otherwise, the Officer of the day shall, if possible, have it replaced. Should it be impossible to replace the mark in time for the boats to round it, the Officer of the day shall decide whether the race is to be restarted or not.

Protection buoys may be placed on the circuit.

304 - SIGNALS FROM THE SHORE

304.01 - CALL SIGNALS

When a race, or heat has been started a call signal shall be put up to inform the drivers in the pit area which class is the next to start.

A signal consists of a 35 x 90 cm white board, with the class designation (O500, S850 ...) in black.

The signal should be put in a place where it is easily read from the pit area. If two or more classes start together the call signals for these are to be put up together.

If the time to the next start is so long, that it is not necessary to put the boats into the water immediately, the signal can be supplemented by a sign of similar size and colours showing the estimated starting time.

304.02 - FLAG SIGNALS

The flags used for signalling are the same for all series and must be used in all countries.

The flags used for signalling have the following meaning:

Red: to stop the race and mark serious danger on the circuit;

Yellow: danger on the circuit;

Minimum size of red/yellow flags: 1000 mm x 600 mm

Black: The driver to whom the flag is shown must immediately return to the pits where he will receive instructions from a race official. The flag must be accompanied by the race number of the boat to be stopped.

Chequered, white and black: finish;

Chequered, white and red: course mark showing the safety zone;

Green: This is the signal that all boats are ready to go to start procedure.

304.03 - STARTING IN GROUPS

If the number of drivers entered is too large for all of them to start together, the Race committee has to split the group of drivers into several groups.

The Race committee will have each group race a selection race followed by a second chance heat. It is recommended that time trials are run to evaluate boats into the two groups instead of random selection.

Drivers of one same nation must be evenly distributed into separate groups.

Example: based on a circuit that can accommodate 20 boats, with 30 entries.

2 groups of boats;

After the selection heats:

the first 8 in each group are selected = 16 boats

A second chance heat grouping the 14 boats that have not been selected:

the first 4 in this heat are selected = 4 boats

Participants in the final heats: 20 boats

The number of laps in the qualifying heats will be reduced and this number, which will be fixed by the organiser, must be mentioned in the advance-programme and recalled at the drivers briefing.

A minimum of one-hour interval is required between the last qualifying heat and the first final heat.

The championship will then take place in four heats, the three best heats for each driver being taken into consideration in the final classification.

If necessary, after all the qualifying races, the organisers reserve the right to make up the number of boats in the final races to the maximum permitted from the repechage heat, when any qualified driver indicates that they cannot participate in the final heats. This cannot be done after the first heat.

305 - THE START

305.01

Starts are:

- flying start with clock (14 boats maximum)
- dead engine start.

305.02

After the starting signal has been given, no boats are allowed on the course other than competitors and official service craft.

305.03

Any boat starting late shall not cross the starting line later than 5 minutes after the starting signal has been given in circuit races (heat races).

Any boat starting late is not allowed to start after the first boat which finishes the race has crossed the finishing line.

Any boat starting late is not allowed to start after the delay provided for in the advance-programme in endurance or long distance races.

306 - FLYING START WITH CLOCK, DISCS AND GUN

The clock must have a dial of no less than 2 meters (6ft. 3/4 ins.) and marked out as follows:



This clock is to be driven electrically or mechanically. It has only one hand moving continuously and indicating the seconds.

The official start is given by the clock. The discs and the gun are supplementary to the clock.

The clock must be run for the majority of the training periods.

306.01 - PLACE OF THE CLOCK

The clock must be placed 3 or 4 metres before the starting line and less than 5 metres above the water level.

306.02 - DISCS

A set of five discs, each having a minimum diameter of 40 cm (15 3/4 ins.) pivots in a white frame. One side of the disc is black and the other white. The discs are numbered 5, 4, 3, 2, 1 on the white side. The figures must be 25 cm high at least and 5 cm thick. These discs are worked by hand. It is recommended, to use discs as large as possible.

Discs must be located in a place which is clearly visible to all the drivers. Sometimes, it is necessary to have two sets of discs (one close to starting line and the other easily visible from the boat park).

306.03 - GUN

Any audible signal loud enough to be heard above the sound of the motors. The gun may be replaced by a rocket pistol.

No other signal than those described above are to be used.

306.04 - STARTING LINE

The starting and finishing line is marked by two poles erected on the shore and surmounted by a triangular mark with one top upwards and one top downwards.

Both poles are erected on the shore at different heights placed in line one behind the other adjacent to the jury.

The distance between the starting line and the first turning buoy must be at least 300 metres (984 feet).

The distance between the shore and the inside safety buoys before the starting line must be at least 50 metres (164 feet).

306.05 - SAFETY ZONE

It is compulsory to determine a zone of 150 metres minimum in length marked by one or two buoys with a red and white chequered or striped identification at one end, the other end is the starting line marked by one or by two buoys with a black and white chequered or striped identification.

306.06 - BEFORE THE START

During the five minutes preceding the start, boats must not enter in this safety zone, except for the start.

When the warning signal is given 5 minutes before the start, no boats are allowed to be on the water except racing boats and official boats.

The rules of the road (Rule 312) are also applied in that zone. Any infringement will lead to the disqualification for that particular heat or race.

The organisers using this starting system must use a still or movie-camera or a video tape recorder which must be synchronised with the clock.

306.07 - THE START

The start will be given as follows:

- a) 5 minutes before the start, the class letter is hoisted and a gun fired. The five discs are shown with the numbered side towards the course. The hand of the clock is placed on the zero position (12 o'clock).
- b) 4 minutes before the start, the disc number 5 is turned black.
- c) 3 minutes before the start, the disc number 4 is turned black
- d) 2 minutes before the start, the disc number 3 is turned black
- e) 1 minute before the start, the disc number 2 is turned black, the clock is started
- f) At starting time, the disc number 1 is turned black. The clock is stopped and a gun is fired.

The clock, discs, letters and gun and camera / video must be synchronised.

306.08 - APPROACHES TO THE STARTING LINE

Any boat approaching the starting line other than at a right angle within a zone of 150 metres minimum (495 feet) marked by at least one buoy with a red and white chequered or striped identification (which must be left to port), will be disqualified. Boats can not enter in this zone during the five minutes preceding the start, boats must not navigate in the reverse direction of the course and rules of the road apply.

A boat which has not left after the starting signal, can not pass in reverse direction between the starting line.

A mandatory training period will be held to allow drivers an opportunity to familiarise themselves with the safety zone and approach to the starting line prior to actual competition.

306.09 - BOAT STARTING BEFORE TIME

Boats starting before time are disqualified for that race, heat or series.

Boats which cross the starting line in either direction during the five minutes before the start are disqualified and get zero points in that heat.

If the numbers of boats which started before time are all known the race continues and is valid but the boats which started before time are disqualified for that race (or heat).

If the Race Committee cannot note all the numbers of the boat which started before time, it will restart the race. The leading boat across the starting line that starts before time will be disqualified and not allowed to participate in the restart of that race.

307 - DEAD ENGINE START FROM A QUAY, A JETTY OR A BEACH

307.01

All start jetties of the relevant classes should be inclined up to 50 degrees to the line of travel at the start.

Whilst every effort must be made by the organisers to obtain this, a jetty start can still be used even if perpendicular.

Boats should be drawn up stern first, engine dead, to a jetty, floating stage or beach. Boats without electric starts may have external aid from the jetty.

The jetty or floating stage must be long enough for all boats starting plus a length equal to 0.75metres for each boat and with a minimum width of 2.5 metres .

The jetty must be stable even when the maximum permitted boats plus maximum 3 mechanics per boat prior to launch. If not the numbers starting must be reduced and must be reported to the UIM by the Commissioner.

Positions on the jetty are determined by individual qualifying times or from qualifying heats.

Jetty positions for qualifying heats should be taken from available lap times and not by random choice.

Pole position boat does not have the choice of ends. This is announced by the OOD at the drivers meeting [if challenged]

When qualifying heats are run the jetty positions for the actual final heats are allocated by the times from the two heats. The qualifying boats from the "repêchage" heat are positioned at the lower end of the jetty.

Jetty positions, in multi-heat races, after the first heat, are the finishing positions in the prior heat.

307.02

The distance between the start line and the first turn mark must be in a straight line and at least 300 meters.

At dead engine starts, drivers must keep their relative jetty positions to the first turning buoy in a straight line and through completion of that turn. Sufficient room on the inside must be left by the leading boat, if not pole, to allow others higher on the jetty to negotiate the turn. The inclusion of a starting buoy for safety does not count as the first turning buoy when keeping your lane. From then on it is the ordinary rules of the road.

Breaking this rule will result in disqualification, one lap penalty or a yellow card.

It is prohibited to stand up during start and while racing.

At all dead engine starts at international titled races, the start may be videotaped (or similar). This is to be done from a position as high as possible and/or from a place in extension of the start lane.

307.03

The start will be given as follows:

Two minutes before the red light is switched on a gun is fired or a flag signal is given. Alternatively the time can be lengthened to 3 minutes if notified at driver's meeting.

One minute before red light a "1" minute signal is given.

30 seconds before red light a "30" signal is given.

Engines must not be run after this signal.

At the end of the 30 seconds the red light is switch on.

After 5-12 seconds the red lights are switched off, this is the signal to start.

307.04

Those drivers running their engines during the last 30 seconds before the start are disqualified.

Those drivers starting their engines or leaving the pontoon whilst the red light is on lose one lap.

Those drivers rotating their engines (with ignition switched off) prior to the red lights going off lose one lap.

After an announced time the red light will be shown again.

Late starters: A driver who has failed to start before the red light is shown again, must wait until the whole field has passed the start jetty and the pontoon marshal indicates that he may join the race in the proper way.

The O.O.D. may decide to cancel the start by showing the red flag and recommence the starting procedure.

Any boat starting unsuccessfully must be returned to shore. Any crew member swimming, or wading, out to a boat will cause his entry to be disqualified.

307.10 - MATCH RACE RULES

Qualifying from time trial position. (numbers on sheet are timed trial qualifying positions).

Qualifying matrix for 16 boats

- *First elimination round*
- *Quarter-finals*
- *Semi-finals*
- *Third place race*
- *Final*

Qualifying matrix for 8 boats

- *First elimination round*
- *Semi-finals*

- Third place race
- Final

Course

- Three pin course (by a straight line)
- Round the first turning buoy it should be a sausage buoy (safety zone) to keep the lane for both drivers
- The third buoy is the same for both drivers
- Finish line is the same for both drivers
- Both drivers do one long and one short lap
- The longest lap should not be more than 800 m total

Start

- By light
- From a pontoon
- Side by side
- Inside driver go for the shortest lap
- The outside driver goes for the furthest buoy
- With double heat the driver switch lanes
- If a drive does not start the other driver must complete the course

Finish single heat

- The driver who passing the finish line first is the winner of this Match Race heat, there may be time keeping, if required for minor places overall position.

Finish double heat

- The driver who made the best average time is the winner of the double heat

Penalties (disqualification)

- Non-start
- Jump start
- Cutting course
- Impeding other course

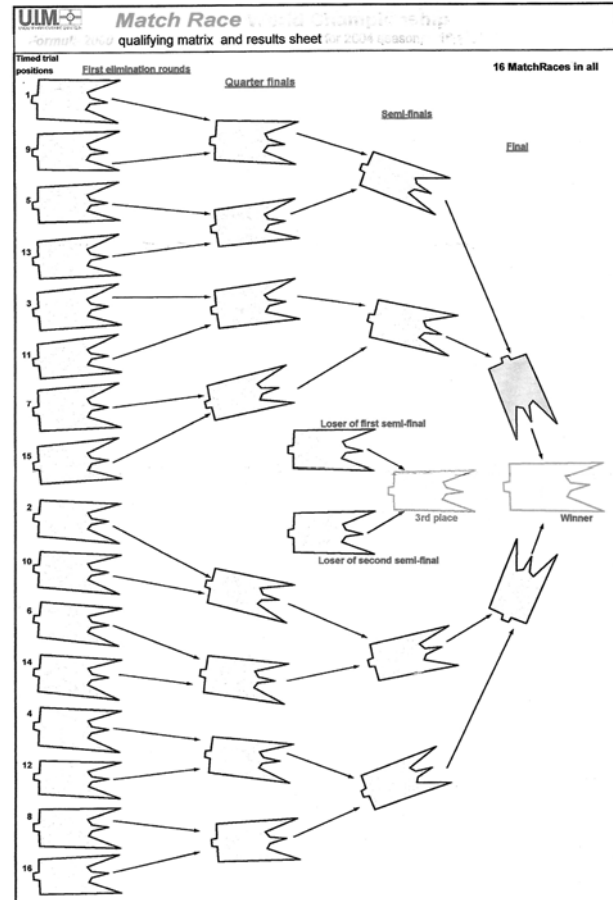

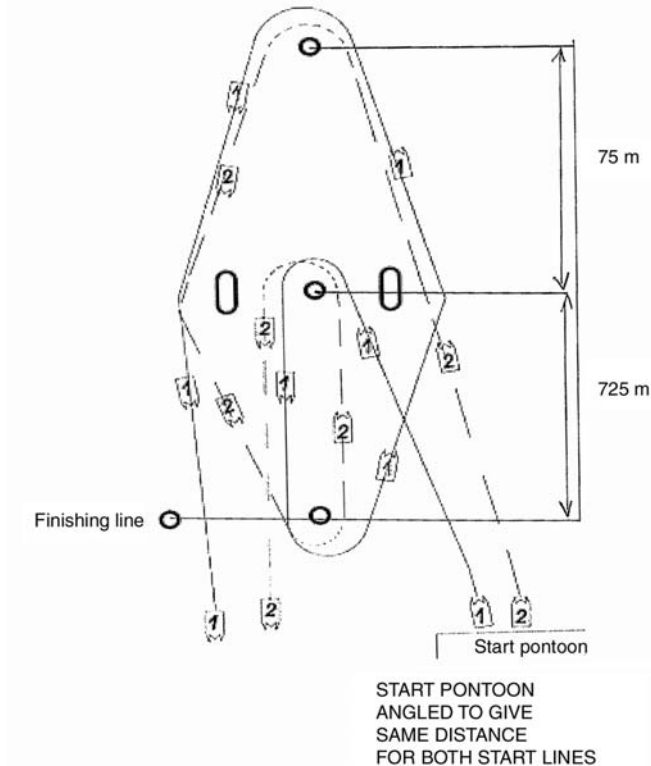

308 - RACE CANCELLED

The Race Committee has the power to cancel any race should unfavourable weather or other serious circumstances render such action necessary.

309 - RACE POSTPONED

309.01

The Race Committee has the right to postpone a race, in which case the letter "R" and the class letter are hoisted. Races this postponed are subject to written notice on the notice board.

The Officer of the day may postpone the start, even after the first signals have been given, but only in cases of force majeure or if an error in the starting signals has been made.

309.02

In both cases, signalling is to be recommenced. When the need for postponement has passed, the Race Committee signals the start according to the instructions contained in the programme.

New entries are not to be accepted for postponed races.

Only drivers who duly entered and were present when the race was postponed are admitted.

309.03

A race or heat must in no case be postponed more than 24 hours. If it is impossible to race within this time, the other races or heats held will be used as a basis for classification.

310 - RACE SHORTENED

A shortened race is a race over a course which has been shortened by the Race Committee before the start.

If a race is shortened due to force majeure, it is at the discretion of the OOD (and the U.I.M. Commissioner if present) to alter the time table, and if necessary the course layout accordingly.

If the race is declared to be on rough water, the number of laps should ideally be maintained, but may be reduced if seen fit by the OOD. If time permits, the circuit layout can be changed, as agreed by the OOD, U.I.M. commissioner and the driver's representative.

If there is a change to the race course after time trials, there may be extra fee practise, if time permits.

The decision with instructions about the shortened course must be handed in writing to the drivers and the timekeepers.

311 - RACE STOPPED AND RE-STARTS

311.01 - GENERALLY

1. A stopped race is a race interrupted by the OOD after the start.
2. The stopping of a race is the sole decision of the OOD and officials specifically mandated by the OOD. A signal to stop a race will be the display of a red flag and/or a red flare or red smoke. It is recommended that the start lights are turned toward the general direction of racing after the start and switched on, in a red flag situation as an additional warning.
3. A race is also stopped when anybody is in the water on the course or is considered to be injured, and/or continuation of the race constitutes a danger to those involved.

4. Drivers whose actions result in a stoppage shall not be scored or restart. If the sanctioned driver protests, he shall be permitted to restart, the result being subject to the decision of the jury. So that the racing is not delayed, and protest about the inclusion of a driver after stoppage may, at first, be verbal. A normal written protest must be submitted after the end of the heat or race.
5. Any penalty incurred in any heat is carried forward to any restart of that heat or race.
6. Disqualified drivers shall not restart (unless under protest see 4).
7. Jetty positions are the race positions at the end of the lap prior to the stoppage.
8. Drivers who do not succeed in reaching the jetty with the power of their own engines shall not restart. This rule applies only for classes with electric start.
9. Repairs may only be carried out on boats that have returned to jetty (Rule 8). Repaired boats may rejoin the race as directed by the jetty marshal. Further definition of the repair areas will be given at drivers briefing.
10. In the event of a restart any repaired boat must be ready to take up its correct position on the jetty as directed by the jetty marshal. If the boat is not ready it must start from the bottom end of the jetty. If the race has already restarted the driver can only start under the directions of the jetty marshal.

311.02 - RACING IN HEATS

1. When the leading boat has completed less than 70 % of the required laps the race shall be restarted.
2. There shall be only one restart.
3. Laps gained in previous starts are discarded.
4. The restart shall be for the original number of laps and re-fuelling is permitted. Place for re-fuelling shall be indicated by the organiser.

5. Only the drivers scored at the lap before the stoppage shall be eligible to restart.
6. When a race is stopped after the leading boat has completed at least 70 % of the required laps there is no restart and full points are awarded.
7. Points for a restarted race which is also stopped are:
up to 35 % of the required laps: 50 % POINTS
over 35 % of the required laps: FULL POINTS

Up to 35% means: 'After lead boat has completed at least one full lap and can all be identified by timing control. Failure means zero points.

Minimum one full lap and provided timing control has been able to identify.

311.03 - SINGLE HEAT RACING

1. Eligible drivers may rejoin restarts even if not in previous starts.
2. The race shall be restarted when after having deducted one lap for each stoppage the remaining laps are at least 20 % of the original total.
3. Eligible drivers must return directly to the start, no outside assistance, no refuelling.
4. The number of laps to be scored are those at the end of the lap prior to stoppages.
5. Laps scored from the original start and all restarts shall be aggregated for final positions.

312 - RULES OF THE ROAD

312.01

All racing boats must take any action to avoid a collision at all times.

312.02 - OVERLAP

An overlap is only established when two boats are approximately on the same course and the cockpit of the overtaking boat, if passing on the inside, is even with the cockpit of the overtaken boat.

When overtaking from the outside, an overlap is established when the overtaking boat has passed the overtaken boat sufficiently to alter course without contact.

312.03

The leading boat has right of way until an overlap is established.

312.04

A safe overlap and overtaking manoeuvre is the responsibility of the overtaking boat.

312.05

After an overlap manoeuvre, the overtaken boat must give the overtaking boat room to negotiate turn buoys.

312.06

The overtaking boat cannot force an overlap situation once the lead boat has started his turning manoeuvre.

312.07

An overlap can be attempted from either side of the leading boat.

312.08 - OVERTAKING

An overtaking boat shall keep clear of the boat which is being overtaken.

312.11 - PASSING MARKS

When trying to overtake a boat on the inside, the driver must anticipate the possible direction of the boat he is trying to overtake and must take all necessary action to avoid a collision.

When passing a turn buoy and an overlap has been established, both boats must maintain a safe distance from each other and from the turn buoy.

Overlapping while overtaking does not give priority to the boat overtaking on the inside.

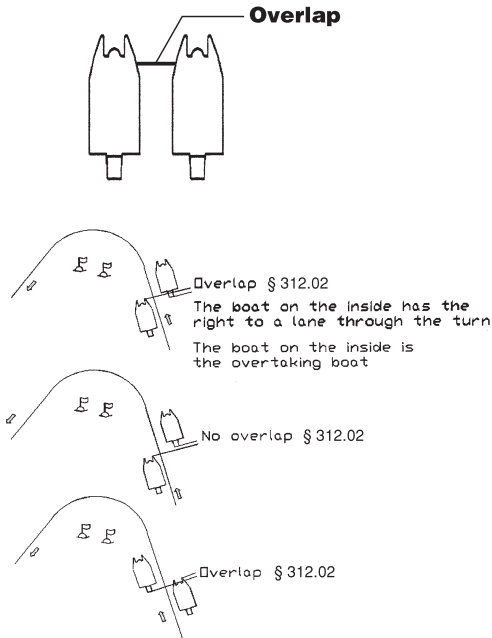

312.12 - ALTERING COURSE

When one of the boats is obliged to keep clear, the other shall not alter her course, to avoid risk of fouling.

A boat must not bear out of her course so as to hinder another in passing to the right.

313 - ROUNDING AND FOULING MARKS

313.01

All marks must be on the left side of the boat unless otherwise stipulated in the advance programme and repeated during the drivers meeting.

On circuits with both left and right hand turns, orange turn buoys must be for left hand turns and yellow buoys must be for right hand turns.

313.02

A boat which rounds a mark in the wrong way loses a lap. For safety reasons, a boat is not allowed to round the mark again after rounding it the wrong way. A boat which rounds a mark again is disqualified.

A boat is considered as having rounded a mark in the wrong way when the buoy official considers that it has passed the mark on the wrong side after starting to negotiate the turn.

313.03

Every turn on the race course should have two turn buoys.

In the following text first and second buoys refers to the sequence in which they are damaged or destroyed by a boat, not to their position in the turn and the order in which they are to be passed.

In this case, if a driver:

- touches the first turn buoy in a turn: no penalty
- damages or destroys the first buoy: one lap penalty and a fine that will be decided by the Organising Committee and announced in the advance regulations
- touches the second buoy: no penalty
- damages, destroys or dislodges the second buoy: disqualification and a fine that will be decided by the Organising Committee and announced in the advance regulations.
- In the case of a single buoy, penalties will consider that buoy as the second buoy

The penalty lap will be deducted at the end of the heat.

Recommendation: the two buoys should not be tied up together.

313.04

A driver who is forced on to a mark by another driver may lodge a protest against that driver.

314 - FOULING COMPETING BOATS

If a boat, in consequence of her neglect of any of these rules fouls another boat, or compels others to foul each other, she is disqualified.

315 - MEANS OF PROPULSION

All methods of propulsion other than motor and paddle are prohibited.

The action of the wind and current will not entail the disqualification on the competitor.

316 - YELLOW FLAG SITUATION IN PRACTICE / TIME TRIAL

In a yellow flag situation in practice / time trial the driver must slow down to a safe speed.

317 - FINISHING A RACE

317.01 - THE FINISH

The finish is shown to a driver by waving a black and white chequered flag.

317.02

A driver who finishes a race or heat must withdraw from the course without hindering the boats that are still in the race.

Drivers have to fulfil at least one extra lap after crossing the finishing line, unless the organiser specifies something else.

A driver who has finished that race and cuts across the course will be disqualified in that race or heat and get zero points.

A boat is timed as completing a race when her stem crosses the finishing line. After finishing the race, the driver must continue to observe any special regulations prescribed by the Race Committee as to keeping clear of the finishing line and the course.

317.03

The Race Committee has the right to stipulate the maximum duration of each race.

Races for the international classes are limited to 4 consecutive days.

For races on the sea, an interval of consecutive 24 hrs might be conceded, if the water conditions justify it.

318 - SCORING SYSTEM

318.01

The boat placed first will be the one having covered the scheduled distance in the shortest time.

All boats will be classified by taking into account the number of complete laps that they have covered and for those, which have completed the same number of laps, the order in which they cross the finish line.

Unless otherwise specified, the following scoring system is to be adopted in all races consisting of two or more heats:

1 - 400 pts	11 - 22 pts
2 - 300 pts	12 - 17 pts
3 - 225 pts	13 - 13 pts
4 - 169 pts	14 - 9 pts
5 - 127 pts	15 - 7 pts
6 - 95 pts	16 - 5 pts
7 - 71 pts	17 - 4 pts
8 - 53 pts	18 - 3 pts
9 - 40 pts	19 - 2 pts
10 - 30 pts	20 - 1 pts

318.02

To be awarded points a driver shall have completed at least 75 % of the race winner's distance and cross the finishing line after the leading boat has taken the chequered flag.

Only full completed and recorded laps are taken into account when calculating % (Rounded up)

[e.g. Heat of 7 laps. 75% = 5.25 laps. So round up to 6 laps]

For drivers with the same total of laps, their finishing order shall be determined by their positions at the finish of the race.

For single heat races

Boats that complete 90%, or more of the race distance, but do not cross the finishing line after the winner has crossed the finishing line, will be classified after those boats that have done the same number of laps and also cross the finishing line after the winner.

For a race stopped, the finishing order is that existing at the end of the lap prior to the stoppage.

Organisers may limit the race to a given time after the winning boat has finished, this must be mentioned in the advance programme.

318.03

The official results must be posted on the official notice board within an hour of the end of the races.

318.04

A general classification of different classes racing together is not permitted.

318.05

National classes may be raced at international meetings.

318.06

If boats of different series or classes start together every boat must be classified within its own class.

When the programme for a race meeting does not provide races for all classes, boats not provided for may race in the next higher class in the programme, subject to their acceptance by the Race Committee.

318.07

It is forbidden to take part in a race for a lower class than that to which a boat belongs except with the written consent of all competitors.

The Race Committee may hold a race, as a separate class, for one-design hulls equipped with identical motors.

318.08

If post-race inspection reveals that a boat or motor is illegal, that entry shall be disqualified for each heat in which it raced, and the order of finish shall be corrected for each heat. Final overall race positions shall be obtained by adding the points from the heats after the order of finish has been corrected for each heat.

319 - DEAD-HEAT**319.01**

Two boats are in a “dead heat” when :

- They cross the line together
- They obtain the same points in a points race

319.02

In case of a dead heat, the boat having the higher average speed, in any heat, will be declared the winner.

Only full completed heats can be used for this purpose.

If the course has been changed considerably between heats, the average speed cannot be used to declare a winner. Then, the total of the smallest time difference in percent to the winning time in each point giving heat is the winner. The decision about different course has to be done and the drivers informed before the last heat.

319.03

If the above has been applied, and there is still a “dead heat”, the boat having a higher average speed on any lap in any heat, will be declared the winner.

320 - POSTING OF THE RESULTS

The results of each race must be posted at the pits in a clearly visible position, specified during the driver’s meeting.

321 - INSPECTION OF HULLS AND ENGINES**321.01**

Upon completion of a race the engines must remain sealed to prevent any alterations being made.

Refusing to present the engine or the boat entails disqualification.

Any attempt to make changes to the engine or the hull after race and before starting of technical inspection entails disqualification from whole event by the decision of OOD or U.I.M. Commissioner.

321.02

It is compulsory for a driver to make arrangements (tools and special tools and mechanics) so that his motor can be disassembled if the Technical Officers at a post race inspection want to check any part of the motor.

Both driver or/and mechanics shall work as efficiently as possible so that inspection duration can be kept to a minimum.

Engines and boats will be placed pending inspection in a well defined place, which remains under the care of the “ boat park ” official. This is called the “ parc fermé. ”

321.03

After the pre-race technical inspection, the boats must not leave the boat park except for practising or racing.

321.04

If any repairs can only be effected outside the boat park, they must be carried out in the presence of a Technical Officer.

321.05

Officers allowed to attend the inspection:

- The Officer of the Day
- The delegate of National Authority of the driver who's boat/engine is being scrutineered.
- The measurers named by the organising committee
- The driver and a mechanic if necessary
- The U.I.M. Commissioner(s)

The presence of other persons is only allowed if authorised by the Officer of the day.

322 - PRIZES

322.01

Prize giving cannot take place until at least 1 hour after posting of provisional results and NOT BEFORE the technical post race inspection is finished and a protest time against its results has expired.

The Race Jury, in the meantime, must not be dismissed.

It is recommended that immediately after the final race, the provisional first three drivers are paraded in front of the spectators, and introduced to the public and to the media on the official podium.

322.02

A National Authority may ask to reduce the number of prizes according to the number of competitors. However, the value of the prizes must be maintained, as provided for in the advance-programme. This possibility must be explained in the advance-programme.

322.03

In S, T and P series Titled events, the final heat must be completed at least 2 hours before the scheduled time of prize giving to ensure the technical scrutineer has enough time to find the correct winners.

323 - REPORTS

323.01

At the end of the meeting, the Secretary of the Race Committee must send to the Sports Commission of his National Authority a report including:

- 323.011** Classification and distribution of prizes:
- 323.012** Report of the timekeepers;
- 323.013** List of drivers;
- 323.014** Penalties:
- 323.015** Documents on any records achieved in conformity with the U.I.M rules;

- 323.016** List of protests and decisions relating to these protests;
- 323.017** All necessary documents in order to evaluate the meeting or the race;
- 323.018** These documents must be sent to the Sports Commission of the National Authority within 8 days of the end of the meeting or the race;
- 323.019** After each titled meeting, the organisers must send the results to the Secretariat of the U.I.M.
- 323.020** If the results are taken into consideration for the granting of a trophy or a prize, the points must be sent to the U.I.M. by fax and/or e-mail within 48 hours;
- 323.021** 3 days after a competition, the organising club must send the final result to the National Authorities of all the participants and to the Secretariat of the U.I.M.
- 323.022** Details of technical disqualifications of drivers to be reported to their National Authorities per rule 502.07.

400 - JURISDICTION

401.01 - DEFINITIONS

Jurisdiction applies to:

The U.I.M. Offshore, Circuit, Aquabike Rules.

401.02

No claim for damages arising from an infringement of any of the U.I.M. rules or the advance notice or any of the race instructions or race bulletins shall be adjudicated upon by any race committee or appeal authority, but shall be subject to the jurisdiction of the courts.

The crew of a racing powerboat which acknowledges infringing a rule does not thereby admit liability for damages.

The findings of fact, and the decision of the protest committee shall be relevant only to the purposes of the powerboat racing rules and shall not be referred to in any proceedings for damage without the written consent of all parties to the protest.

402 - JUDICIAL BODIES

402.01 - THE INTERNATIONAL JURY

The Jury hears any protest raised by a driver.

1. Composition

The Jury must be composed of at least three members, the Chairman included. The Organisers of the event appoint the Chairman. Each competing country, including the hosting country, may appoint one member delegate who can represent only one country. These appointments must be made in writing, authorised and signed by a National Authority Official and delivered to the event Secretary.

If there are not enough NA appointed members to form a Jury of three persons, the Organisers must appoint additional members, but only enough to reach three persons.

The Jury composition will be announced at the first drivers meeting. The jury must be present at the first drivers meeting.

Race Officials can not be Jury members.

The U.I.M. Commissioner appointed to the event is a full member of the Jury.

In an event comprising races of several classes there may be a different Jury for each class.

2. Authority and Duties

The Jury sits as long as the event lasts, and hears all protests relating to that event.

The jury must decide as soon as possible on all protests presented to it during the event.

402.02 - INTERESTED PARTIES

No member of a Jury who has taken part as a competitor or Official in the race concerning which a judgement is to be given, or knows himself to have directly or indirectly an interest in one of the parties involved, may judge the protest.

However, a member of an International Jury shall not be disqualified even if one of the parties is from his NA.

402.03 - THE U.I.M. APPEALS BOARD

The U.I.M. will decide on Appeals arising from International events according to the provisions laid out in Rule 405.1.

In each case, the U.I.M. Executive Committee, or in case of an appeal lodged against an Executive Committee's decision, the appointed neutral Council member will nominate three members, one to be Chairman after consultation of the relevant commission. The members must not be from the National Authorities of the parties to the case.

One member will act as Clerk to the Board.

403 - PROTEST PROCEDURES

403.01 - VALIDITY OF PROTESTS

Only a driver may protest against facts pertaining only to the races in which he takes part.

Joint protests signed by several drivers will not be considered.

All protests must be in writing - type written or hand written in printed characters in English.

It must state the reason for the protest and be accompanied by any relevant documents that shall provide evidence within the given time and any protest fee as stipulated by the Race Organiser.

All protests must be signed by the protester.

The protest must be handed to the Race Secretariat who must, in the presence of the protester, record the time of receipt.

Any costs involved in verification are to be borne by the losing party.

A written protest can be withdrawn by the protester; he then loses the protest fee.

403.02 - PROTEST FEE

The amount of the Protest fee must be decided by the National Authorities and it must be published in the advance programme. The maximum amount for a Protest fee will be decided by the U.I.M. General Assembly. It will be 80 €, or an equivalent sum in the national currency.

The Jury must determine whether the protest presented to it, has been lodged according to the rules. If found to be invalid, the reasons must be given to the protester.

If a protest is upheld by the Jury, the fee must be returned to the protester.

403.03 - RIGHT OF PROTEST

A protest can be lodged against the posted provisional results or against any decision made by the Race Committee or against one or several competitors.

In the event of a competitor protesting against a penalty imposed on him by the OOD or the U.I.M. Commissioner and another driver protesting simultaneously against this competitor due to the same incident, the jury will have only one meeting with both competitors being party of this protest procedure.

A protest can only be lodged on a subject which directly concerns the protester himself. A protest which complies with these rules can not be refused by the Jury.

No protest is permitted on jury decisions, they may only be contested by appeal.

403.04 - TIME OF LODGING A PROTEST/ PROTEST PERIOD

A protest regarding the qualification of a boat, a motor, or a driver must be made before the drivers briefing. Starting in a race is considered as acceptance of the conditions and the eligibility of the other competitors. The only exception to the above is when the protester can prove the facts were not given to him before the drivers briefing, then a protest can be lodged up to one hour after the posting of the results.

Any other protest must be lodged within one hour of the first results being posted with the following exceptions:

A protest of a driver (driver "A") against another driver (driver "B") can be lodged within 15 minutes after the expiry of the normal protest period if driver "B" has been penalized by the OOD or the U.I.M. Commissioner and protested himself against the penalty.

A protest against new results can be lodged within one hour of these new results being posted, but only concerning the decision, which lead to the changing of the results.

A protest against any other decision, posted after the posting of the first results can be lodged within one hour after the posting of this decision.

Posted results are provisional for 1 hour.

If post-race scrutineering is foreseen, this must be stated on the results sheet and the results will remain provisional until 1 hour after finalization of the post-race scrutineering.

403.05 - JUDGEMENT

Decisions by the Jury shall be reached by simple majority of votes. In the case of equal votes, the Chairman's vote will be the casting vote.

In the event of a protest, penalties may be agreed, rejected or changed by the jury.

Any judgement pronounced by the Jury stays in effect until altered by the Appeal Board.

403.06 - NOTIFICATION OF DECISION

All decisions by any jury must be notified to the concerned parties in writing, including their right of appeal.

403.07 - AVAILABILITY OF DOCUMENTS

All documents relevant to any decision by the Jury must be filed with the organising N.A. and held available for a higher authority until the time limit for an appeal has expired.

404 - HEARING OF THE PROTEST

404.01 - RIGHT TO A HEARING

Any person being party to a protest, or being charged for an offence against the rules shall have the right to be heard before the Jury in order to defend himself.

The Jury must give notice to all parties of where and when the hearing will take place.

If any party duly notified, fails to appear without giving an acceptable reason, judgement can be rendered by default.

404.02 - EVIDENCE

It is the responsibility of the parties involved in a protest to ensure that witnesses appearing on their behalf together with any other evidence are present and the Chairman of the Race Jury at his/her sole discretion may take their availability into account when determining the time of the hearing.

Any costs incurred by the appearance of witnesses shall be borne by the respective parties unless decided otherwise by the Jury.

404.03 - THE HEARING PROCEDURE

The following procedure must be followed in all hearings unless otherwise stated elsewhere in these rules:

- Written minutes must be taken.
- All parties to the case are entitled to be present and to hear and question all evidence at the hearing up to the time the Jury makes its decision. The protest, shall be read out to the parties.
- The parties shall be invited to state their cases. The parties may call witnesses. Each witness, after having given his account of the case, may be questioned by all parties and by the members of the Jury.
- Any member of the Jury who is familiar with the case may give his evidence
- The parties shall be entitled to question each other and any member of the Jury who may have given evidence.
- The witnesses shall withdraw and the parties shall be invited to make a final statement of their cases.
- The Jury may recall any party, previous witness or new witness and call on other evidence **to verify the facts.**
- The parties must be present during the whole of the recall and must be given the opportunity to question any new evidence after which they may re-make their final statements.

405 - THE APPEALS PROCEDURE

With reference to the 405 appeals procedures, any time limits which end on a Saturday or Sunday shall end on the following Monday.

405.01 - APPEAL BOARD

The members of the Appeal Board may hold other sports functions and consist of a Chairman and two members.

The Appeal Board sits whenever the Chairman calls a meeting.

405.02 - INTERESTED PARTIES

No member of an Appeal Board who has taken part as a competitor or Official in the race concerning which a judgement is to be given, or knows himself to have directly or indirectly an interest in one of the parties involved, may judge the appeal.

405.03 - RIGHT OF APPEAL

A decision by a Jury may be appealed by the parties involved in the jury meeting when they consider that an injustice has been made against them and/or fresh evidence has been made available that may alter the decision of the Jury.

A driver can also appeal:

- a penalty imposed against him

without the prior lodging of a protest, but only if this was not possible, because the race jury has had dissolved itself before or within the protest period.

405.04 - NOTICE OF INTENTION TO APPEAL

The intention to appeal must be notified in writing to the Secretariat of the U.I.M. by the interested party within four days of the day following the Jury decision or in the case of a decision against which a driver can appeal without the prior lodging of a protest within four days of the day following the notification of this decision to the NA of the driver or if earlier to the driver himself.

405.05 - TIME LIMIT

All appeal documents and fees must be received within ten days from the date when the notice to appeal was received by the U.I.M. Secretariat.

405.06 - LODGING OF AN APPEAL

The appeal must be sent by telefax, letter or E-mail and it must be signed by the appellant. The reasons for the appeal must be stated.

Address, telephone, e-mail and/or fax should be clearly mentioned on the appeal, so that the U.I.M. can send any correspondence directly to the driver with copy to relevant N.A.

405.07 - NOTIFICATION OF THE PARTIES OF THE APPEAL

The U.I.M. Secretariat must within two days from receiving the appeal, notify by telefax or letter the other parties that an appeal has been lodged and that they may send a rejoinder.

Eventual rejoinders must be received within ten days from receiving this notification.

405.08 - TIME LIMIT FOR DECISIONS ON APPEALS

All appeals must be determined no later than forty-five days after the date when the appeal documents and fees were received by the U.I.M. Secretariat.

405.09 - APPEAL BOARD DECISIONS

The Appeal Board takes its own decision based on every information available. The decision of the jury may be upheld, changed or not upheld. The decision of the Appeal Board is final.

405.10 - COSTS

The appeal fee is 1525 €. In addition the driver has to pay 2290 € to the U.I.M. for possible costs of the appeal committee (meetings, telephone or fax costs). The appeal fee for a single championship/ invitation race (not a Formula race, or a WOC race or similar) is 760 €, in addition the driver has to pay 760 €, to the U.I.M. for possible costs of the appeal committee.

The driver who appeals has to pay for the meeting costs anyway if the appeal is upheld or not. If the costs of the appeal committee is less than 2290 € then the difference will be paid back to the driver.

The appeal fee of 1525 € will be refunded if the appeal is upheld. If the original decision is changed by the appeal board (405.09), it can decide to refund a percentage of the appeal fee if appropriate. If there is an infringement to rule 405.05, the Chairman of the Appeal Board can decide that the appeal is not considered valid since the expiry dates were not respected. In this case 50 % of the received appeal fee will be reimbursed to the appellant.

The driver may agree to forego an Appeal Committee meeting and for the appeal to be handled through telephone, E-mail and fax, if possible, in order to minimise the cost for the appeal.

406 - PENALTIES

406.01 - GENERAL

Any proven breach of applicable Rules may be penalised.

If the rules do not determine a special penalty for the relevant breach, the penalty to be given has to be proportional to the seriousness of the breach. The proportionality is at the discretion of the decision maker.

The U.I.M. Executive Committee or the relevant National Authority shall only impose penalties, when they deem the relevant infringement to be so serious, that it has to be penalized although the deadlines for penalizing or lodging a protest have already expired. After the expiry of the aforementioned deadlines, a penalty for an ordinary breach of the rules shall in general not be imposed.

The Race Jury or the Appeal Board following a protest or an appeal can (only) impose penalties, which can be imposed by the OOD.

406.02 - DEADLINES FOR PENALIZING

The OOD and the U.I.M. Commissioner can only impose Penalties until the moment, the first results of the race are posted.

The National Authority and/or the U.I.M. Executive Committee can only impose penalties within 3 month from the day, the infringement occurred.

These deadlines are not valid for penalties imposed by the OOD for the reason of post race technical scrutinizing. In this case, the penalty has to be imposed as soon as possible after the receipt of the scrutinizing results.

406.03 - UNACCEPTABLE BEHAVIOUR

In order to protect the interests of the sporting community, the following actions may also be penalised by the OOD, by the U.I.M. Executive Committee or by the NA of the Licence Holder.

- any deliberate act taken to gain unfair advantage.
- any false act made or statement given with the intention of suppressing facts required for the proper conduct of the race.
- any attempt to bribe or the taking of a bribe.
- any abusive or unsportsmanlike behaviour.

406.04 - REPRIMAND

A Reprimand is a notice of disapproval of an unacceptable action. It must be recorded by the Race Secretariat. A reprimand must be witnessed. A reprimand automatically constitutes warning that if the offence recurs, a heavier penalty will be given. A Reprimand is valid for 12 months.

A reprimand can be given by the OOD, or the National Authority of the Licence Holder.

406.05 - YELLOW / RED CARDS

A yellow or red card may be given by the OOD or U.I.M. Commissioner.

A yellow or red card will be confirmed on UIM form which will be posted with the results and if it is confirmed it must be included in the commissioners report. The recipient must be notified privately before a red card is posted.

The driver has one hour from the posting of the penalty to protest (rule 403). If the protest is not upheld he can make an appeal (rule 405).

All yellow/red cards count towards the drivers CV.

Yellow/red cards can be given for bad behaviour on the water including :

- up to two yellow cards at a time for dangerous driving ;
- one red card for extreme blatant dangerous driving.

A driver with a red card is immediately prevented from taking any further part in the event or further heats if a multi-heat race.

A driver with a red card or three yellow cards will also lose the right to take part in the next titled UIM race in his classes/formulae. Then all cards are removed.

All yellow cards will remain valid for the four events in which he competes following the date on which the last yellow card was delivered.

Yellow/red cards must be notified to the U.I.M. and the drivers' National Authority within three days.

The U.I.M. will notify all National Authorities when a driver has one red card or three yellow cards and is therefore suspended from international competition.

406.06 - DISQUALIFICATION

Disqualification deletes a competitor from the results of the heat or race where the offence occurred.

Disqualification is done by the OOD.

406.07 - TEMPORARY SUSPENSION

Temporary suspension suspends a competitor, a competitor together with crew, a crew member, or an Official from all or part of an event. Temporary Suspension may be given for serious indiscipline.

Temporary Suspension will be imposed by the OOD.

406.08 - PROLONGED SUSPENSION

Prolonged suspension can be imposed on a competitor, an Official or an organisation for deliberate fraud, repeated or very serious indiscipline or very serious misconduct.

Prolonged Suspension can be imposed only by the NA of the licence holder or organisation, or by the U.I.M. Executive Committee.

A Prolonged Suspension is always international. The NA must immediately inform the U.I.M. of a Prolonged Suspension and the U.I.M. must inform all other NA's.

406.09 - EXCLUSION

Exclusion means a permanent loss of all rights to take part in any activities falling under the U.I.M. and its affiliated organisations. A person or an organisation who has committed a moral or sporting offence of extreme gravity is liable to be excluded.

A sentence of exclusion can be pronounced only by the NA of the licence holder or organisation, or by the U.I.M. Executive Committee.

Exclusion is always International. The NA must immediately inform the U.I.M. when it has imposed a sentence of Exclusion and the U.I.M. must inform all other NA's.

In the case of suspension, prolonged suspension or exclusion, all National Authorities and therefore their affiliated clubs bind themselves to respect the decision and apply it in their own country.

407 - PRIORITY OF THESE RULES

The course of the U.I.M. has to be exhausted, before the dispute can be brought before civil court.

408 - POWERBOAT PROTEST FORM

PART A

is for you, the driver, to complete and hand in within the specified time limit.

PART B

Is for you, the driver, to complete and give to the Protest Jury Chairman at the beginning of the Protest Meeting.

DRIVERS PROTEST FORM PART A

SECTION 1

NAME OF EVENT: _____ DATE OF RACE OR HEAT: ____

HEAT NUMBER: _____ CLASS: _____

SECTION 2

YOUR NAME (PROTESTOR) _____

YOUR BOAT NUMBER: _____ BOAT NAME: _____

SECTION 3

I (the Protestor) am protesting against: (tick ✓ as appropriate)

- To seek **correction** from the Race Organising Committee for actions or omissions.
- Another driver, name: _____ Boat No: _____
- The Results as posted

SECTION 4

Which rule has been infringed _____

Time of incident: _____

On which lap was the incident _____

Where was the incident _____

What is the desired result of protest _____

SECTION 5

Your signature _____

Time of signature _____

SECTION 6

You must see this section completed by the official receiving this Protest:

Name of official: _____

Time Protest received: _____

Protest fee received: _____

PART B

SECTION 7

Either, explain incident with another driver; in writing and by drawing;

Or, explain your reason for Protesting against the Race Committee:

500 - INTERNATIONAL SERIES AND CLASSES

500.01 - DEFINITIONS

The general racing rules and the rules governing records are applicable to all international series.

By boat we understand any vessel used in powerboating (hydroplane, monohull, catamaran etc....).

A boat is a vessel that floats on the water when stationary and continuously derives support, directional control or propulsive effort from hydrodynamic forces.

500.02 - INTERNATIONAL SERIES AND CLASSES

The following example serves to clearly define the words "series" and "class":

The series of Racing Outboards is divided into twelve capacity classes being: 125cc, 175cc, 250cc, 350cc, 500cc, 700cc, 850cc, 1000cc, 1500cc, 2000cc, 3000cc and ∞ cc.

The request to accept any new international series or class has to be presented by at least three National Authorities.

All series and classes for which the rules have been drawn up by U.I.M. are international.

All national bodies are bound to observe these rules without any alteration whatsoever. Only U.I.M. has the right to change the rules.

500.03 - RECOGNISED SERIES AND CLASSES

All national series and classes for which the rules have been properly established by a National Authority are recognised by U.I.M.

500.04 - ENTRY LEVEL RACING CLASSES

U.I.M. proposes to establish, in each National Authority, Junior classes (as from 12 years of age) in conformity with the national legislation.

U.I.M. will publish the list (unrestrictive) of classes already in operation (i.e. APBA classes, OSY 400, etc.).

U.I.M. reserves the right to propose other classes and to draw up, whenever required in the future, international rules permitting competition between countries.

500.10 - RULES - FORMULA FUTURE

1. PARTICIPANTS AND EQUIPMENT

1.1 Participants

Classes (5 age groups)

Class 1	Girls and boys	8 - 9 years	(until 31 of December)
Class 2	Girls and boys	10-11 years	(until 31 of December)
Class 3	Girls and boys	12-13 years	(until 31 of December)
Class 4	Girls and boys	14-15 years	(until 31 of December)
Class 5	Girls and boys	16-18 years	(until 31 of December)

In order to participate in the competition girls and boys must be able to swim and have a relevant waiver of responsibility signed by their parents or tutors.

Teams set up by the educational institutions, sport clubs and other organisations can take part in the competitions. Each team includes two competitors (pilots) from every age group.

Each team must have an official adult representative and a trainer (coach).

A team nominates a captain.

The drivers must wear sports clothes and low sole shoes with no heels.

The international jury composing of at least 3 members representing different competitive parties should be set up.

In case the participating Nations are more than 3 (three), the Jury's members should be enlarged in their number in order to have the representation of each nation; on the other hand the 3 (three) members, as mentioned above, are to be chosen with public drawing among the Official Delegates. The composition of the Jury must be exposed before the driver's registration.

1.2 Boats and engines

Boats, engines, propellers and other equipment indispensable to run a race are provided for by the organisers. The above boats, engines, propellers and other equipment should be of usual commercial production.

Drivers in classes 1-3 (8 to 13 years old) use RIB type boats, powered by an outboard engine with a minimum power of 5 h.p. (3.7 KW) and a maximum power of 8 h.p. (6 KW), with manual engine steering (tiller arm), if possible with automatic reverse and must be equipped with 2 (two) separate kill switches. ***Each boat in categories 1-3 must have every time the possibility for the co-driver to stop the engine immediately, using a separate kill switch or an own connection to the drivers kill switch.***

Drivers in classes 4-5 (14 to 18 years old) use RIB type boats, powered by an outboard engine with a minimum power of 10 h.p. (7.3 KW) and a maximum power of 15 h.p. (11.2 KW), with steering wheel, speed lever, seats for the drivers and must be equipped with 1 (one) kill switch.

Boats certified for the races must have the following dimensions (sizes):

- Length max. length – up to 3,6 m

- Width 1,3 – 1,7 m

When registering, the weighting of the driver is to be conducted. The balancing of the driver's weights by the additional weight is to be done within each class.

Statistical average weight:

Class 1 girls and boys	8-9 years	32 kg
Class 2 girls and boys	10-11 years	40 kg
Class 3 girls and boys	12-13 years	52 kg
Class 4 girls and boys	14-15 years	64 kg
Class 5 girls and boys	16-18 years	71 kg

For participant with lower weight, ballast must be used, securely attached to the boat, to be located near the driving position. In the relevant classes, the co-drivers must be the same. Alternatively they may be different but carrying ballast located near their position, to have the same weight.

At the end of the drivers weighing procedure, the list of them for each Nation must be exposed with indication of the race number, name and surname of the pilot, sex, date of birth (day/month/year), the weight verified and the possible ballast. For classes 1-3 also the name of the co-driver must be indicated.

1.3 Personal numbers for the drivers

When passing a registration procedure each participant receives a personal number and a registration form. It is obligatory for the driver to wear a personal number at the time of the race. This personal number presents a white-colour square of 25 cm to 25 cm and has black figures of 20 cm high.

1.4 Buoys

Inflatable buoys are to be used for all events with a minimum of 70 cm high, marked in order to easily visualize eventual rotations caused by touches showing above water level.

All gates must have a width of 2,50 m between buoys.

Red colour buoys show gates and turns.

Yellow colour buoys show the final gates.

Blue colour buoys for the final turn for 5 class.

White colour buoys for start-finish.

1.5 Flags

All flags should have a dimension of 80 to 80 cm.

Green: Start (departure)

Yellow: Danger on the circuit

Red: Stoppage of the race

Chequered: Finish

2. RACE SCHEDULE

2.1 Advance programme

All participants and official representatives of the teams must familiarise themselves with the Rules. Any modifications to the Rules should be submitted to teams representatives not later than 45 days before any race.

It is mandatory that a drivers meeting be held at the jury office after arrival and registration of the participants.

2.2 Racing format

Race includes 3 stages:

1 stage	Free practice
2 stage	Manoeuvring
3 stage	Parallel slalom with final races

2nd and 3rd stage will be treated as separate championships. Scoring the results will be awarded according to U.I.M. rule 318.

At the end of 3rd stage, points of 2nd and 3rd stage will be added.

An overall title will be awarded to the three first participants of each class who have the higher added score of the 2nd and 3rd stages.

2.3 Description of stages

2.3.1 - Free practice

The manoeuvring race course is laid for the practice on the water. The driver chooses himself – either to practice in speed manoeuvring or in parallel slalom. Timing and duration of the trial is identified by the organiser.

2.3.2 - Manoeuvring

A participant must show his skill in binding knots (see addendum).

All participants run a manoeuvring according to the drawings attached to each class.

Each participant has 2 attempts of which the best is taken into account.

2.3.3 Points system

U.I.M. points are given to the drivers according to the following scoring system:

1 – 400 pts	8 – 53 pts	15 – 7 pts
2 – 300 pts	9 – 40 pts	16 – 5 pts
3 – 225 pts	10 – 30 pts	17 – 4 pts
4 – 169 pts	11 – 22 pts	18 – 3 pts
5 – 127 pts	12 – 17 pts	19 – 2 pts
6 – 95 pts	13 – 13 pts	20 – 1 pt
7 – 71 pts	14 – 9 pts	

2.3.4 - Parallel slalom

The slalom course is laid out as shown in the attached drawings.

The speed race is to take place on the parallel slalom race course.

Each driver has 2 attempts. After the first attempt the drivers change with boats and race courses.

Drivers, having 1-4 result in each class, participate in the semi finals and finals.

The classification is defined according to time results and a number of penalty seconds. The U.I.M. points are given to the combined time results with penalties according to the U.I.M. rule 2.3.3.

2.3.5 - Semi finals and finals of the Parallel Slalom

Pairs setting for the semi-finals: by personal numbers of the drivers.

The results must be done after the semi-finals. Each driver must have the place (1-4) according to the result which he has in semi-finals (time).

Drivers with **1st** and **2nd** results compete for **1st** and **2nd** places.

Drivers with **3rd** and **4th** results compete for **3rd** and **4th** places.

2.3.6 - Restart to the competition

If the engine stops during the race, the driver should start it again by himself (in 1-3 classes the co-driver's assistance is allowed) and finish the race. After the race is finished the driver has the right to submit a protest. The commissioner decides whether to allow a restart or not.

3. SAFETY MEASURES

Each boat is equipped with two separate kill switches. (classes 4-5 boats only one kill switch).

Each boat in categories 1-3 must have every time the possibility for the co-driver to stop the engine immediately, using a separate kill switch or an own connection to the drivers kill switch.

In classes 1-3 a co-driver is compulsory and must accompany a pilot.

Each driver and a co-driver must wear a helmet and a life jacket provided for by the organisers.

Organisers cover all the drivers with an insurance against accidents.

4. PRIZE GIVING / RESULT

Prize giving is arranged for by the organisers.

The prizes are given for:

1st, 2nd and 3rd places – manoeuvring (2nd stage)

1st, 2nd and 3rd places – parallel slalom (3rd stage)

1st, 2nd and 3rd places – total individual competition (sum of 2nd and 3rd stages)

1st, 2nd and 3rd places – team competition

Individual competition

U.I.M. points for manoeuvring and Parallel slalom are calculated and summed up and a total number of points form a ranking list.

The three best drivers are awarded by prizes.

Team competition

The final result of the team competition is defined by a number of the U.I.M.-points of the three best results from each team in manoeuvring and parallel slalom in a total of 2 400 points. The results must show time of posting and are signed by the OOD and the chief timekeeper.

Protocols

Protocols should be posted after being submitted for approval by all judges and should be signed by the main referee and the secretary of the race.

Protocols must be organized separately in every stage in columns showing clearly:

Manoeuvring: knots test penalties; 1st attempt times; penalties; 1st attempt times with penalties; 2nd attempt times; penalties; 2nd attempt times with penalties; best times including knots test penalties; ranking; UIM points

Parallel slalom preliminary heat / semi finals / final: 1st attempt times; penalties; 1st attempt times with penalties; 2nd attempt times; penalties; 2nd attempt times with penalties; attempts added times; ranking; UIM points

Individual competition / General: Manoeuvring overall UIM points; Parallel slalom overall UIM points; UIM summed up points / ranking

Team competition: Manoeuvring three best results / UIM points (identification of the relevant drivers and classes); Parallel slalom three best results / UIM points (identification of the relevant drivers and classes); UIM summed up points / ranking.

5. ENTRIES

An enrolment application must be addressed to the organisers 4 weeks before the date of the event.

6. DESCRIPTION OF THE RACE

All participants must complete the prescribed disciplines according to the drawings and guidelines attached to each class.

Drivers run against the clock.

Classes 1 - 3 sit in the boat. At classes 4 - 5 participants must sit on the jockey seat and may hold the side inflatable areas of the boat to increase stability and safety.

Sitting on the side of the inflatable boat or bending is forbidden and leads to the disqualification.

6.1 Departure

Departure is implemented without an additional touching of the starting pontoon.

Additional touch leads to a 5 seconds penalty.

6.2 Desembarquement

After passing the finishing line a boat must land smoothly. Bumping a landing pontoon is penalised.

6.3 Man-over-board

This manoeuvre is implemented in classes 4 – 5.

The boat must come to the mark on its left side. It must be absolutely stopped.

Reversing or setting the engine on neutral could do stopping. Manoeuvring the boat backwards is not allowed and driver must be disqualified.

After absolutely stopping of the boat a driver rises up a safety belt (or similar) over the head by both hands and lay it down without throwing it or dropping it down and then continues the course.

Faiure to do it from the first attempt will lead to the next, but the driver must move only forward.

6.4 Binding knots

A skill should be demonstrated in binding the following knots:

- Reef knot
- Bowline
- Half-hitch
- Clove-hitch

7. RESPONSIBILITIES

Participation in the events is carried out at somebody's own risk. Non-sportive behaviour of the team members will lead to disqualification of the driver for the relevant heat. Non-sportive behaviour of the accompanying persons is not welcomed.

8. CAPTAIN OF A TEAM

Each team must nominate a captain (among the drivers) whose responsibilities are to provide management and guidance as well as to look after proper behaviour of his young team mates.

9. DEFINING A WINNER

Defining a winner of "Manoeuvring".

Defining a winner of "Parallel Slalom"

Points received in 2nd and 3rd stages are added. The overall winner / Champion is the one with the highest number of UIM points (classification).

Dead-heat situations will be decided according to UIM Rule 319.02.

10. PROTESTS

Protests are accepted according to the U.I.M. rule 403. Protests should only be submitted by the team representative.

11. PENALTIES

- Additional touch of the starting pontoon	5 seconds
- Bumping the landing pontoon	10 seconds
- Touching of the turn buoy	10 seconds
- Touching the buoy while reversing	10 seconds
- Passing the gate not with the full length of the boat	20 seconds
- 2nd and 3rd attempt each element of the race course (each attempt)	10 seconds
- 4th attempt of the race course	Disqualified
- Improperly done knot (each)	5 seconds
- Participants standing during manoeuvring or parallel slalom race	Disqualified (attempt or total)
- Sitting on the side of the inflated boat or bending	Disqualified (attempt or total)
- Boat didn't stop at the mark during manoeuvre Man-over-board	10 seconds

- Boat goes backwards during manoeuvre
Man-over-board Disqualified (attempt or total)
- Rising a safety belt with one hand 5 seconds
- Rising safety belt not above the head
(lower than a head of the pilot) 10 seconds
- Putting down the safety belt with one hand 5 seconds
- Dropping or throwing a safety belt on a mark 10 seconds
- Second attempt to rise the safety belt 10 seconds
- Error doing the circuit Disqualified (attempt or total)
- Coming to the mark from wrong side Disqualified (attempt or total)

12. LANGUAGE

All the preparatory work and correspondence between the U.I.M., organisers and participating countries will be carried out in compliance with p.1.1.2 of the U.I.M. Statutes and By-laws. All the technical and public announcements should be done both in English and the language of the host country.

Note: as to the other technical matters with regards to description of the race, advance programme, timing, entries, race circuits, determination of the winner and time counting etc. should be as per U.I.M. general rules.

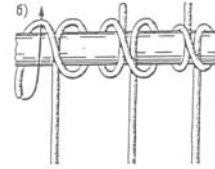

Clove hitch

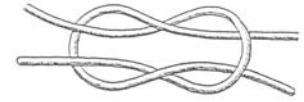

Reef knot

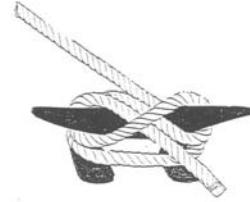

Half hitch

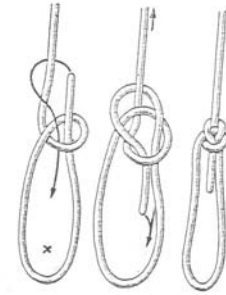

Bowline

Course scheme of the children's powerboat competitions in maneuvering "Formula Future"

Parallel Slalom

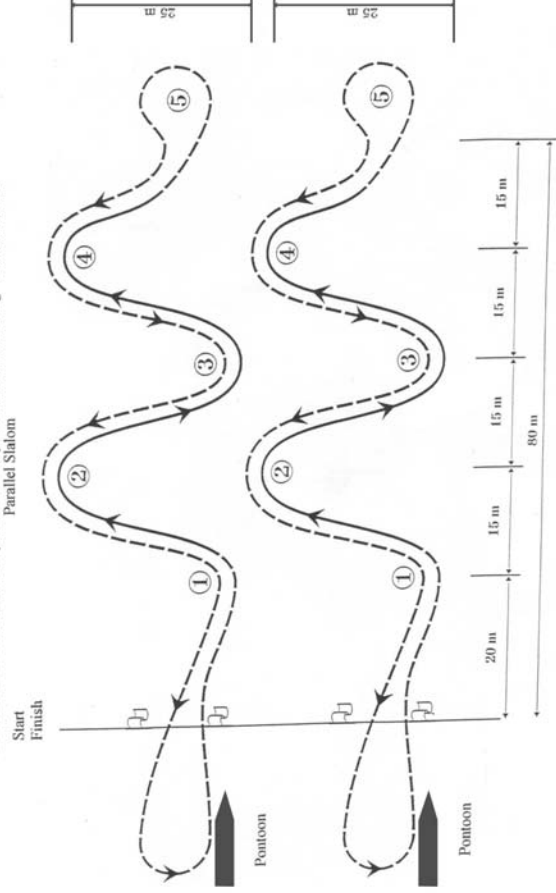

Departure - start line - along the course through the gates 1, 2, 3, 4, 5 - turning behind the gates 5 - again front motion through the gates 5, 4, 3, 2, 1 - finish line - return to pontoon - mooring

Course scheme of the children's powerboat competitions in maneuvering "Formula Future"

Class 1

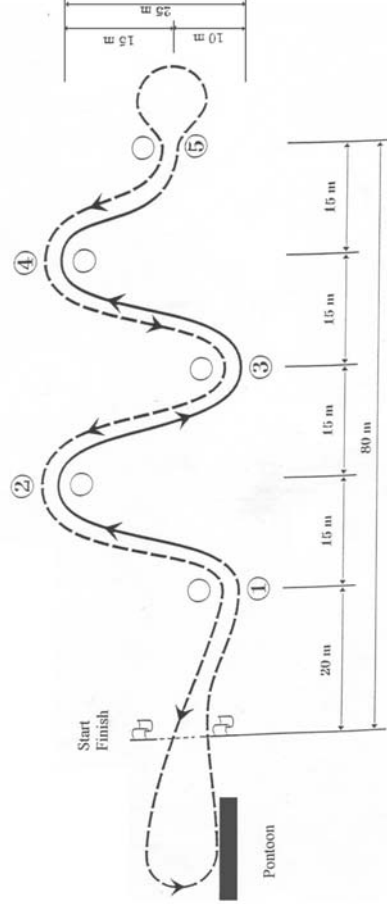

Departure - start line - along the course through the gates 1, 2, 3, 4, 5 - turning behind the gates 5 - again front motion through the gates 5, 4, 3, 2, 1 - finish line - return to pontoon - mooring

Course scheme of the children's powerboat competitions in maneuvering "Formula Future"

Class 2

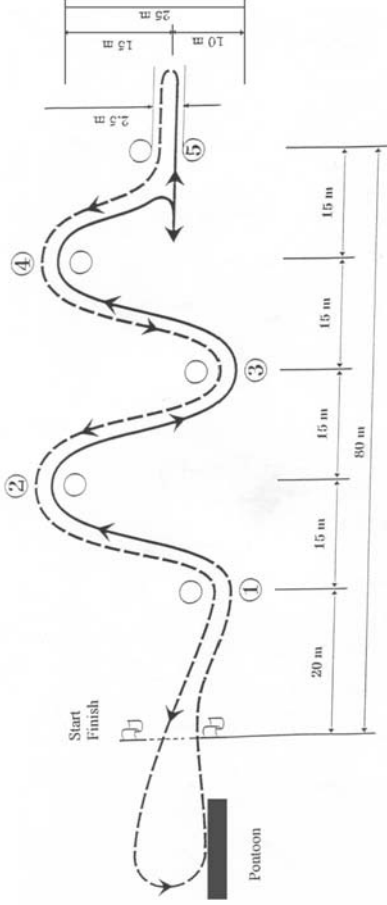

Departure - start line - along the course through the gates 1, 2, 3, 4 - by reversing to the gates 5 - again front motion through the gates 5, 4, 3, 2, 1 - finish line - return to pontoon - mooring

Course scheme of the children's powerboat competitions in maneuvering "Formula Future"

Class 3

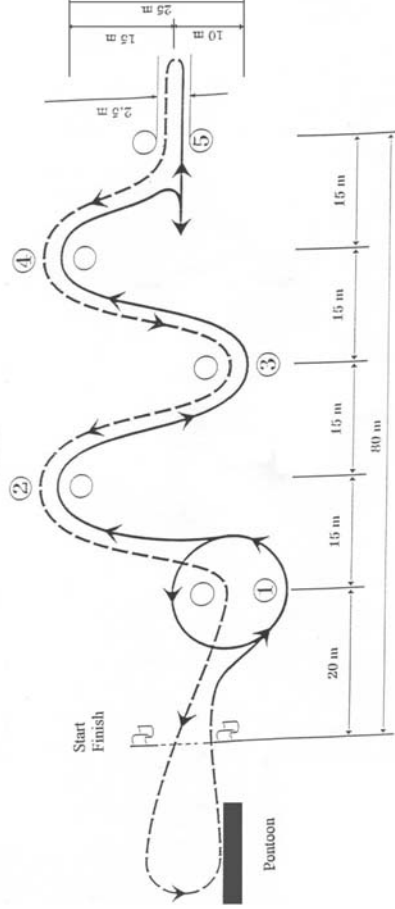

Departure - start line - detour of the gates 1 are on the left side of the boat) - along the course through the gates 2, 3, 4 - by reversing to the gates 5 - again front motion through the gates 5, 4, 3, 2 - finish line - return to pontoon - mooring

Class 4

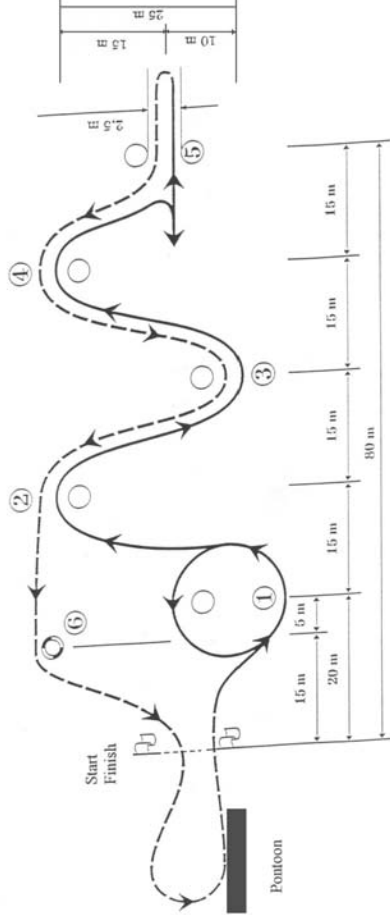

Departure - start line - detour of the gates 1 are on the left side of the boat) - along the course through the gates 2, 3, 4 - by reversing to the gates 5 - again from motion through the gates 5, 4, 3, 2 - maneuver "man over-board" at buoy 6 - finish line - return to pontoon - mooring

Class 5

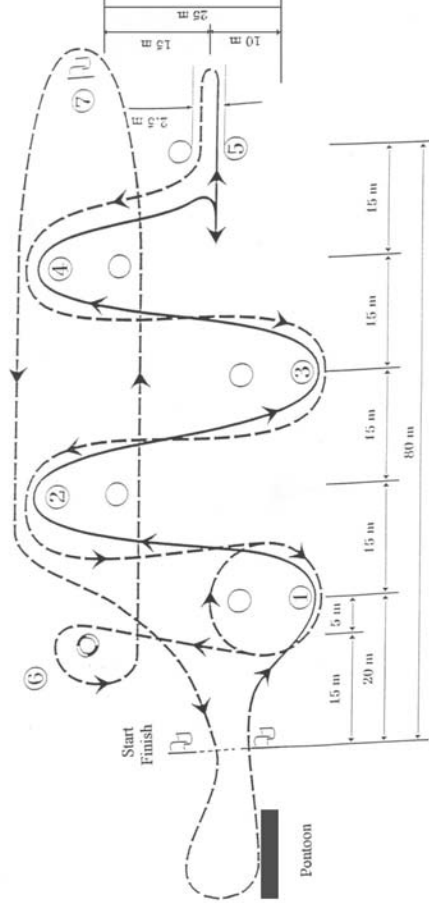

Departure - start line - along the course, turn around the gates 1, 2, 3, 4 from outside - by reversing to the gates 5 - again front motion, turn around the gates 4, 3, 2 from out side - quick detour of the gates 1 (the gates 1 are on the right side of the boat) - maneuver "man over-board" at buoy 6 - speed round: from inside gates 2 and 4, round buoy 7 and from outside gates 4 and 2 - finish line - return to pontoon - mooring

501 - MEASUREMENT CERTIFICATE

A boat is not allowed to take part in an international race without a measurement certificate, issued by a National Authority, made up in the native language and in French or English according to the official U.I.M. model. The certificate is valid for one year. It can be renewed without re-measuring, provided the rules for the relevant class have not been changed.

When measuring a boat with a reinforced cockpit, all specifications in rule 509 must be checked.

501.01

Each National Authority stipulates the cost of measurement and the duration of the validity of the certificate.

The request to obtain a measurement certificate must be accompanied by the homologation file of the motor, if such is requested for the devices being used.

501.02

Any owner who has made alterations affecting the measurements in the certificate must notify his National Authority at once. Non observance of this rule invalidates the certificates. The National Authority re measures the boat at the owner's expense. Any boat that has been altered but not re measured is not allowed to race.

501.03

Any international measurement certificate must be as described hereafter, and must be adopted and used by all National Authorities and the U.I.M.

501.04

The serial number of the motors may be omitted in the measurement certificate.

UIM Union Internationale Motonautique		NA National Authority	
MEASUREMENT CERTIFICATE			
NUMBER	CLASS	SERIE	
Owner_____			
Club_____			
Boat Name_____			
SAMPLE			
Measurer_____			
National Authority_____			
Date_____ Valid till_____			

HULL					
BUILDER _____ YEAR _____					
DESIGNER _____					
MATERIAL _____					
LENGTH	BEAM	WEIGHT	COCKPIT		
			LENGTH	BEAM	DEPTH
ENGINE					
BRAND _____					
TYPE _____ YEAR _____ N? _____					
HOMOLOGATION N? _____					
SPECIFICATIONS					
CYCLE		N?			
CYLINDER		N?			
BORE		mm			
STROKE		mm			
CYLINDER VOLUME		c	m ³		

501.05

No blank certificate may be issued by National Authorities. Documents must be completely filled in with all particulars pertaining to the series for which the boat is measured. The certificate must also be signed and stamped by the National Authority.

501.06

Drivers need only supply and measurers need only check such particulars as are applicable to the class of boat.

501.07

Anyone involved in the design, building (manufacturing or marketing) of a hull or motor in any other way has an interest in a certain boat is not to measure the boat .

501.08

All measurements should be taken at least twice. Measurements should remain within the limits provided for on the homologation sheet.

501.09

The owner of a vessel pays all fees and expenses for measuring his boat and/or motor(s).

The measurement certificate is only to be handed over when all dues have been settled by the owner to the National Authority.

501.10

When a re measurement is made at the request of the National Authority, the expenses and fees for such re measurement are paid by the National Authority if the first measurement is upheld.

501.11

A log book is mandatory for all boats equipped with reinforced cockpit, to be filled out by the race scrutineer indicating the race location, date, and if any damage occurred to the cockpit or boat. It will be part of the measurement certificate.

502 - INSPECTIONS**502.01**

Hulls, motors, fuel, accessories and equipment, subject to restrictions regarding dimensions or other characteristics, must be submitted for verification.

All race boats must be inspected before going in the water, and as a help to the inspectors they may use the recommended minimum check list

PRE RACE INSPECTION

At every race meeting, the boats must be inspected before going in the water due to safety reasons.

Minimum check list for Pre-race inspection of race boats

BOAT NUMBER	U.I.M. art.
Life jacket	205.06/509.04
Crash helmet	205.07
Lifting eyes and slings	205.12
National flag	206.01
Boat number on boat deck and under cockpit	206.02/509.19
Mooring eye	503.01
Paddle (not required in boats with reinforced cockpits)	503.01
Flotation	503.01/509.02

Throttle & ignition cut off	503.03
Steering drum and steering cables	503.05
Rigging of fuel systems	503.05
Rigging of electrical systems	503.05
ID plate on cockpit	509.01
Seat belts and belt buckle (check for wear)	509.03
Driver fitting in cockpit	509.05
Water deflector	509.07
Energy absorbing padding in cockpit	509.08
Sharp edges in cockpit	509.09
Removable steering wheel	509.10
Rear view mirrors	509.11
Motor shut off switch outside of cockpit	509.12
Air vents	509.14
Water inlet holes in back of boat	509.15
Bottom of cockpit coloured orange	509.19
Oil absorbing carpet	703
Main power switch (electrical)	Formula Rules
U.I.M. Sticker for all titled events	Formula Rules
Oil	508.07
Drivers must be able to show:	
– a valid license	
– a valid measurement certificate for the relevant class	
– a complete homologation sheet (if mentioned in the measuring certificate)	

- all pages should have a U.I.M. or N.A. original stamp
- a copy of the boatbuilder's U.I.M. registration for reinforced cockpits
- a valid immersion test certificate (§ 205.05) for boats with reinforced cockpits
- a current U.I.M. rulebook
- for drivers with a physical handicap, a doctors written approval that the driver may race (mentioning any special conditions)

502.02 - MOTOR INSPECTION

Verification of motors in restricted series is carried out according to the facts contained in the homologation file.

At world record runs, world championships and continental championships, inspection of the winning motor is compulsory.

Inspections may also be done whenever found necessary at all international and national events.

The following procedure is mandatory for these inspections:

1. Check that the motor type code and visual appearance conforms with the motor homologation sheet.
2. The measurements stated in the homologation sheet must be checked on the motor. If the results are within the specified tolerances the motor should be accepted as legal. Only adjustments to meet dimensions shown in the homologation sheet are allowed.
3. When ports in cylinders are adjusted to the dimensions specified in the homologation sheet, material may only be removed in the specified opening to a depth of 10 mm, to match the shape of the original adjacent connecting passage (channel) outside the adjusted port opening. This also applies to other openings in the motor for which the dimensions are specified in the homologation sheet.

4. Parts not specified with measurements in the homologation sheet shall only be checked by visual comparison with standard parts. As the actual manufacturing tolerances are not published, small differences between the inspected part and the reference part must be accepted.
5. Cylinder dimensions and compression volume are measured when the motor is cold. Allowance is made for the carbon and oil present in the combustion chambers. Checking is to be done with oil. A large scale graduated cylinder or burette with adequate orifice is to be used.
6. Inspection procedure for the low emission engines will also be clarified in the homologation sheet.

502.03

The driver must report with his boat at the inspection and must comply with the rules of the organising race committee.

502.04

Technical inspectors have the right, once races are over, to carry out all the checks they consider necessary, even when inspection has taken place before practice, and they have the right to inspect as they think fit.

The post-race inspection should be about speed and power enhancing matters.

502.05

Drivers are at all times responsible for the condition of their boat (hull, motors, accessories, equipment, etc.).

502.06

Errors, if any, on the part of the manufacturer, builder, mechanic or even the previous owner do not justify non conformity with the rules.

502.07

A driver who does not comply with the decisions or instructions given by the Technical officers, or who infringes any rules which it is the duty of the technical officers to check is not allowed to start in the race, or should he have raced shall be disqualified and reported to his National Authority, for possible further penalties.

A Breach of the technical rules, will result in a disqualification from the entire race or heat. Exception is that lost or broken engine parts, required by rules or homologation, result in disqualification only for the relevant heat if repaired or replaced for subsequent heats.

Foreign drivers are to be reported to their own N.A. through the N.A. of the organising country.

Each N.A. must then inform U.I.M. of further penalties, or reasons why no further penalty has been given by his N.A.

A driver who refuses his boat and/or motor to be inspected after a race shall be penalised as severely as for a serious infringement of the technical rules.

If this occurs at a international titled event, a mandatory penalty will be that the driver will loose his right to participate in international events for 12 months.

502.08

It is prohibited to change the crankcase, the hull or its sponsons after qualifying races (if any) and after the start of the first race/heat.

These items can be changed during or after the timed trials, in this case the times achieved with the items used before the change is void.

The replacement engine will require sealing and the exchanged boat or sponsons, will be considered as a new entry, requiring full scrutineering. If no timed practise opportunity remains, the boat will start from the end of the grid.

Any outside assistance on the race course, for repairs or any other reason will result in disqualification.

If any repairs can only be effected outside the boat park, they must be carried out in the presence of a Technical Officer.

503 - EQUIPMENT - PEOPLE ABOARD MOTORS

503.01

Every boat must be fitted at the bow with a towing eye, and every re-inforced cockpit boat must be fitted at the bow with two mooring eyes, one at the top and one at the bottom which must be strong enough to support the boat if it sinks and to make towing possible.

One or two oars or adequate paddles, adequately secured and stowed, so that they are immediately available, are to be on board. Boats with reinforced cockpits do not need to have oars or paddles.

Every boat must have adequate buoyancy to ensure that it floats in case of an accident. This buoyancy shall be equivalent to a volume of 0.055 m³ of foam per 100 kg. of boat weight. If a reinforced cockpit is fitted, at least one half of this volume must be securely attached to the cockpit structure. Any foam is to have a maximum density of 30 kg/m³.

The flotation provided by the airbag is not to be included in the calculation for required flotation.

503.02 - WINDSCREEN

Boats must be uncluttered and the windscreen if fitted must be easily removable to present no obstacle to the driver getting free, and to not impede lifesaving and salvage operations.

The edges of the coamings and the windscreen must not be sharp and must be lined with rubber or other similar material to avoid injuries in case of accident.

503.03 - AUTOMATIC THROTTLE SHUT-OFF

All boats must be fitted with an efficient automatic throttle shut-off device as well as an automatic device in the ignition circuit which will stop the motor if the driver is thrown out.

Boats with reinforced cockpits do not need to be fitted with this kind of ignition shut-off device.

The device must be clearly visible, as must be the link to the driver. The link must be short enough to be efficient.

The system must be working at all times during a race, practice or trials.

A driver who does not conform is disqualified in a race or is made to pay a fine in case of practice or trial runs.

Lanyard connection to the life vest is required to shut off the fuel on boats with electric fuel pumps.

503.04

During a race, the boat must have onboard all the equipment required by the Race Committee in the detailed instructions contained in the advance programme.

503.05

All attachments, navigation lights, hand holds, steering gear, pulleys, fairleads, cleats and anchor eye, etc. must be bolted to the hull.

503.06

In all series, there must be only one driver per boat.

The Race Committee may rule otherwise in the advance program for long distance races.

503.07 - PISTON MOTORS

Reciprocating piston motors are to be fitted on boats of the international series.

The total cylinder capacity of the motor or motors forms the basis for eligibility in the corresponding classes.

The motors may be of the two stroke types. They may have carburettor(s) or fuel injection.

503.08 - ROTARY MOTORS

Rotary motors with trochoidal rotors are admitted on the basis of an equivalent cylinder capacity.

The rotary motor capacity is twice the volume determined by the difference between the greatest volume and the least volume in the working chamber.

503.09 - SUPERCHARGING

When the motor includes a device used for supercharging it, the nominal cylinder capacity is to be multiplied by 1.4. and the boat will pass into the class corresponding to the calculated volume resulting from this operation. The supercharger must be a standard part of the motor. A dynamic air inlet for ducting the atmospheric air toward the motor's air intake is not considered as a supercharging device.

503.10 - FINS

Fins are not allowed to be retractable underway.

503.11 - ELECTRICAL ISOLATION

All boats, with batteries, must have an isolation switch as close to the positive terminal of the battery(ies) as practicable (negative terminal if positive earth system).

The opening handle of the switch must be easily accessible on the deck or other surface of the boat on the port side between 1 to 3 metres forward of the stern.

This switch must be marked with a red flash + and the "On/Off" positions shown.

504 - NOISE REDUCTIONS

504.01

The use of an efficient device to attenuate the noise is compulsory.

A race organiser shall have at hand a sound level meter as described below as well as personnel trained in its use.

It is recommended that associated National Authorities obtain such meters and lend them to race organisers when needed.

504.02

The noise level must not exceed levels listed below, except for A- and TR- serie boats.

504.03

The noise level is measured by means of a precision sound level meter which conforms to the specifications laid down by I.E.C. and A.N.S.I., using the "A" weighting and set to slow response. The registering microphone is placed at a distance of 25 m 90 to the course of the boat with no interfering objects within 25 m. The boat must pass the microphone at top speed in two directions.

The measurements must be carried out while the boat approaches the microphone and while moving away from the microphone. The measuring must start when the boat is minimum 100 m before the closest point on the course to the microphone and continue until the noise level has dropped considerably from the measured value.

Neither of the measurements is to exceed 91 dB(A) with a 2 dB(A) tolerance for motors up to 750 cc, and 91 dB(A) with a 4 dB(A) tolerance for motors above 750 cc.

Only for motors up to 750 cc, without water pump

If the above method is not practicable, reference measurements may be made with the boat on dry land, the motor running under no load at a mean piston speed of 13 m/sec. The microphone must be placed 0.5 m from the exhaust orifice and at a height of at least 20 cm above the ground. The maximum noise level, using a meter as above is to be 101 dB(A) with a 2 dB(A) tolerance. This level is experimentally determined and may be changed.

505 - ENGINE HOMOLOGATION

505.01 - COMMITTEE OF AUTHORITY

UIM Powertrain is the sole committee of authority for the process of UIM engine homologation.

505.02 - HOMOLOGATION FEES

Validation of the final homologation file is subject to the payment of a fee, the amount of which is set every year by the General Assembly. A list of fees is available from the UIM Secretariat.

505.03 - HOMOLOGATION APPLICATION

Engine manufacturers are invited annually to apply to the UIM for engine homologation via their affiliated UIM National Authority of the country of engine manufacturer.

505.04 - MINIMUM PRODUCTION QUANTITIES

The required number of engines manufactured prior to homologation is to be verified by the manufacturer and endorsed by the National Authority of the country of manufacture. If insufficient numbers of engines have been manufactured at the time of homologation, a written certificate, witnessed by a practicing lawyer, of the firm intention to manufacture the specified numbers is required from the manufacturing company which must clearly state the completion date of manufacturing schedule to meet the required minimum production numbers.

505.05 - ELECTRONIC HOMOLOGATION FORMS

Application for homologation must be submitted on the relevant electronic U.I.M. homologation forms. These must be complete and where necessary, accompanied by explanatory notes and/or photos. These forms are available from the UIM Secretariat.

505.06 - DEADLINE FOR APPLICATION

Application for the request of homologation of an engine must be received by the U.I.M. Secretariat (Monaco) by close of 15th October to be considered for validity commencing 1st April in the following year.

505.07 - APPROVAL OF APPLICATION

An application for Homologation, Running Production Change or Extension of Validity will initially be considered by UIM Powertrain and then subsequently considered by the relevant commission of the discipline for which the engine is proposed for use. i.e. Cominoff/Cominsport.

The U.I.M. Commission Cominoff (Offshore) retains the right to refuse approval of an engine homologation application, Running Production Change application or Extension of Validity application if in the view of that commission the granting of such would be contrary to the interests of offshore power boating. A refusal by Cominoff to approve will result in the application being denied for Offshore racing solely.

The U.I.M. Commission Cominsport (Circuit) retains the right to refuse approval of an engine Homologation application, Running Production Change application or Extension of Validity application if in the view of that commission the granting of such would be contrary to the interests of circuit power boating. A refusal by Cominsport to approve will result in the application being denied for Circuit racing solely.

Should the application be approved by the relevant Commission(s), the application for Homologation, Running Production Change or Extension of Validity will be confirmed as accepted and the inspection verification procedure and/or administration of Running Production Change/Extension of Validity will commence.

505.08 - INSPECTION VERIFICATION PROCEDURE

At a time and place agreed between UIM Powertrain and the manufacturer, a production example of the engine and its components will be inspected to ensure that the declarations made by the manufacturer in the homologation application file are justified.

This inspection must be completed before 1st April for the homologation to be valid for commencement in that year.

The homologation becomes valid when all correct and completed documentation including the finalised homologation document has been received by the U.I.M. secretariat.

This must be before 1st April for the homologation to be valid for commencement in that year.

505.09 - TERM OF HOMOLOGATION

A homologation remains valid for ten years from 1st April of the first year of validity. ***However in the final year of validity and if no other effective extensions have been applied for by the manufacturer within the permitted deadlines, the file will be valid until the 31st December of that same year.***

505.10 - ANNOTATION OF VALID DISCIPLINS

The final homologation file will display the specific U.I.M. powerboating discipline(s) for which the engine is approved.

The annotations will be made appropriately as follows:

- CIRCUIT
- OFFSHORE
- CIRCUIT/OFFSHORE

505.11 - HOMOLOGATION FILE COPIES

Copies of homologation files are obtainable against payment of a fee which is set by the UIM annually.

The copyright thus bought allows a National Authority to reproduce the file with as many copies as necessary for its drivers and technical services. A charge may be levied for copies provided by the National Authority.

505.12

Competitors unable to obtain copies of homologation files from their relevant National Authority, may apply directly to the U.I.M. Secretariat for supply of documents against payment of a single fee per copy. Such documents are individual purchases with no copyright and must not be reproduced without specific authorisation from the UIM secretariat.

505.13

For restricted stock UIM classes a homologation sheet is required for engine and propulsion units.

This file is valid only for the model described. Any model derived must be subject to separate homologation.

A copy of the homologation sheet must accompany any engine, boat or accessory used in a class in which homologation is required.

505.14 - RUNNING PRODUCTION CHANGES

Approval of application for running production change must initially follow the rules of 505.07

An application for a running production change may be requested by a manufacturer at any time of the year, although its commencement will be dated from 1st April in the year applied for. Powertrain will confirm whether any requested change is acceptable as a running production change, or requires the engine model to be re-homologated. Modifications to specifications dictated by manufacturing or structural requirements are admitted, but not those primarily aimed at improving performance. (as a guide, any changes or accumulation of changes likely to increase power by more than 5%, or the speed performance corresponding to more than 5% increase above that given by the original homologation specifications, may be grounds for re-homologation).

An approved running production change will be announced on the U.I.M. Website and will be deemed legal for use in racing 30 days after the official date of approval.

The fee for a running production change will be 50% of the full homologation fee.

505.15 - EXTENSION OF VALIDITY

Approval of application for extension of validity of homologation file must initially follow the rules of 505.07

If an engine is actively in use by competitors up to the expiry date of the initial ten year term of homologation, and remains in the same specification as declared in the homologation file, then provided all spare parts are readily available, an extension of validity of the homologation file may be applied for on an annual basis by the manufacturer. If the engine continues to meet these criteria annually, further extensions may be applied for by the manufacture annually.

The application for extension of validity must be applied for using the same dates as Rule 505.06.

The fee for annual extension of validity is 10% of the normal homologation fee.

505.16 - MANUFACTURERS RESPONSIBILITY OF EXPENSES

The expenses of inspection are to be borne by the manufacturer requesting the homologation.

Where International travel is required, the manufacturer must provide a PTA air ticket for the UIM Inspector.

Remaining expenses must be pre-paid and received by the UIM inspector a full seven days before departure of country of residence by the UIM inspector.

Travel expenses for the return trip from home residence to the place of inspection, hotel accommodation and meals are to be pre-paid on production of a pro-forma invoice.

The National Authority of the manufacturer is authorised to charge the manufacturer a reasonable administration fee to cover secretariat expenses.

508 - FUEL

508.01

- 1) To maximise the equality of competition and to simplify the checking of conformity, organisers must arrange the supply of the same fuel for all competitors at all international titled events, except for classes O/125 to O/700 where the fuel is alcohol based (508.05). It does not of necessity have to be free of charge. It is also recommended for ordinary international events.

Organisers must announce in the advance programme.

The cost of fuel that they will be arranging, the octane number, the brand name of the supplier, and the logistic method of making it available, e.g. distribution tanker in the pits or organised shuttle service to a local fuel station operated by the local organiser. Drivers must provide suitable containers for such use, marked in accordance with appropriate international hazardous standards, and clearly marked with the boat race number.

Drivers must use the arranged fuel as provided and must not bring their own fuel to the event. Contravention of this rule will be penalised. Checks may be carried-out on arrival in the pits and during scrutineering.

508.02 - SPORTS ENGINE FUEL (S. T. P. E. - OSY400 - OSYR - F1000 - F2000 - F4 AND O CLASSES – O850 AND ABOVE)

- 1) Fuel will be unleaded automotive gasoline only for use in non-racing automobiles equipped with catalytic converters.
- 2) Fuel may also be intended for sport engines supplied to the organiser by an international fuel company.
- 3) Fuel will have a minimum octane rating of 95 RON, but to maximise engine reliability, organisers must provide the highest octane rating available in their locality.

- 4) All fuels supplied must be in conformity with the minimum requirements of the engine manufacturers

508.03 - RACING ENGINE FUEL (F1 R CLASSES)

- 1) Fuel produced by an international company for motor sports use. Octane rating to be minimum 100RON maximum 104RON. Unleaded fuel is preferred.
- 2) Aviation fuel AVGAS 100LL, may be used. (No longer allowed in EEC countries).
- 3) All fuels supplied must be accompanied by a data sheet.
- 4) All fuels supplied must be in conformity with the minimum requirements of the engine manufacturers

508.04 - DIESEL ENGINE FUEL

- 1) The fuel must be a commercial grade for automotive or marine use, as obtained from normal roadside or marine service stations.

508.05 - ALCOHOL BASED FUEL

- 1) The fuel must be Methanol (CH₃OH) or Ethanol (C₂ H₅ OH)
- 2) The fuel may contain water (H₂O).

508.06 - ADDITIVES

- 1) Only lubricating oil for two stroke engines may be added to fuel. The use of any other additives is prohibited to either the fuel [carburant] or the air intake [comburant]

508.07 - LUBRICATING OIL

- 1) Only two stroke engines that are not equipped with mechanical oil injection systems will be permitted to use fuel with lubricating oil pre-mixed in it.
- 2) The use of environment-friendly oil is recommended in pre-mixed fuel / oil.

508.08 - RANDOM TESTING OF COMPETITORS

- 1) Fuel samples taken at random from competitors during the event will be tested at the race venue, and may also be chemically analysed afterwards at a laboratory.
- 2) The entire installed fuel system may be dismantled, removed from the boat and inspected.
- 3) Gasoline supplied by an organiser will be tested at the start of an event to establish its Digitron value. The result of this test will be posted by the organiser at the time of issuing the fuel.
- 4) In the event that the organiser does not supply fuel and the competitors bring their own, each competitor's fuel will be checked. This will be part of the pre race scrutineering.
- 5) At an event where the competitor's fuel is used, it will be the competitor's responsibility to ensure that at least one litre of neat gasoline is always available for sealing as a sample.
- 6) The presence of illegal fuel at any time will result in the driver being immediately disqualified up to that point.

508.09 - TESTING PROCEDURES

- 1) Gasoline fuel or fuel / oil mixture may be checked at any time using U.I.M. approved equipment and procedures. Meters and equipment will be calibrated each time in accordance with the U.I.M. fuel testing guidelines obtainable from the U.I.M. Secretariat.

- 2) Non-gasoline fuels will be tested in accordance with U.I.M. current procedures. Density test will be performed on non-gasoline fuels. Density of the fuel should be less than **0.85**.

508.10 - DISQUALIFICATIONS, PROTESTS AND APPEALS

- 1) Any competitor's fuel when tested, and judged as illegal, from timed trials, heats or races will be disqualified up to that time.
- 2) The legality of the fuel is to be judged only by the U.I.M. commissioner, or if he is not present at the event, by the technical scrutineer, based on all tests and information available to him at the time.
- 3) Any further infringement of these fuel rules will lead to immediate Temporary Suspension (art. 406.07) from all of the event, where the infringement occurred.
- 4) Repeated violation of these rules the U.I.M. may sentence a stronger penalty.
- 5) Any disqualification must be followed by the sealing-up of two samples of the competitors fuel ,in an approved container of at least 1 litre if possible. No sample to be opened or disposed of unless the U.I.M. inform accordingly.
- 6) If the competitor protests or appeals his disqualification, he will have the right to have the samples checked using Gas Chromatography, or similar tests to establish what components are present in the fuel sample. All costs incurred in this analysis will be paid by the competitor irrespective of the result.
- 7) If one competitor protests another competitor's fuel, there must be a factual basis for the protest, samples will be taken and tested. The protest must be accompanied by a fee of 250 euro which may be used to defray the cost of the analysis
- 8) The result of the analysis which will confirm the presence of illegal additives or not, will be taken as final and cannot be appealed.

508.11

Refuelling

- 1) Refuelling is allowed only at places announced by the event organiser.

508.12

Starting aids

- 1) No chemical starter aids are permitted on the start pontoon except for alcohol based fuels.

509 - REINFORCED COCKPITS

These rules provide only a minimum standard for reinforced cockpits. It is important that constructors continually develop cockpits beyond these minimum's and produce cockpits that exceed these standards.

The approved Newton standard for a cockpit is to be found from the cockpit registration number. A list of registration numbers and the corresponding Newton standards is available from the UIM Secretariat and the UIM website.

All new cockpits registered in UIM classes (Except F1 and F2000) will be registered for 10 years provided they meet the 3000 Newton Test and other current relevant cockpit rules.

FOR OUTBOARD CLASSES UP TO 1500 CC OR (90 HP EPA) AND OTHER COCKPIT BOATS

Any cockpit of 1000 Newton must be updated to 2000 Newton by the addition of enough composite material, to have 2000 Newton cockpit, 1000 + 1000 = 2000. It is recommended to upgrade cockpits to 3000 Newton.

Any cockpit registered but without a 1000 Newton certification must be upgraded to 2000 Newton by a registered 2000 Newton or higher

certified cockpit builder with the addition of at least 2000 Newton of materials and the addition of his cockpit certification number stating if it is a 2000 Newton or 3000 Newton upgrade.

FOR OUTBOARD CLASSES FROM 1501 CC OR OVER 90 HP EPA

Any cockpit must be upgraded to 3000 Newton by the addition of enough composite material, to have 3000 Newton cockpit.

UPGRADING

This upgrading on cockpit must at least be done on both vertical sides above deck, over the helmet area, over the leg area, the backplate, and the entire bottom. An approved cockpit builder who has passed the at least 2000 Newton panel test must do the upgrade.

Upon any upgrade completion, his cockpit registration number must be moulded or ground into the upgraded cockpit.

Cockpits must have two cockpit registration numbers, one for the original cockpit and one for the updated reinforcement. These two numbers must be written in the measurement certificate.

Cockpits built in 2002 and onward must have passed the 2000 Newton test.

Cockpits built in 2005 and onward, for outboard classes from 1501 – 2000 cc and upwards, must have passed the 3000 Newton test.

U.I.M. COCKPIT TEST STANDARD

Sample Construction Requirements

1. Sample quantity must be 3, one of which must include a sample of the joint/bonding of the cockpit halves, transverse to the length of the sample.

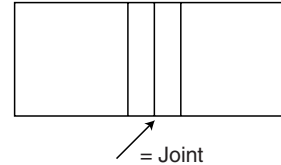

2. Trimmed sample size must be 100mm \pm 1.0mm wide x 800mm \pm 5mm long, with the width being parallel
3. For fibre orientation the 800mm length being parallel with the bottom surface of the intended homologated cockpit
4. Sample must be laminated on a flat surface using the same manufacturing process, materials and fibre orientation's as the intended homologated cockpit construction
5. The sample must have a uniform thickness with no core crushing along any edges
6. The sample must have one moulded face and the other face being unmoulded, the moulded face will be taken as being the external surface of the cockpit during testing
7. The sample must be representative of the thinnest lay-up of the safety cell
8. The sample and cockpit must be manufactured using balanced or unbiased materials

Sample Test Method

1. The sample will be supported across its full width perpendicular to the 800mm edges by two parallel 25mm Steel bars at a distance of 500mm apart. The load will be applied equally through two 25mm Steel bars, each a distance of 167mm parallel from each support
2. The moulded face of the sample will have the load applied and the unmoulded face will support the sample

3. The load will be applied at 0.4mm/sec and the deflection will be measured at the two 25mm Steel bars applying the load within 2 minutes.

Sample Test Requirements

1. The sample when loaded with a force of 3000N must have no more than a maximum deflection of 25mm without the sample failing
2. The sample weight in grm/m² will be calculated, skin thickness and sample thickness will be measured to enable inspection and comparison of damaged homologated cockpits
3. Further non-destructive test analysis methods maybe used to compare test samples with homologated cockpits during the life of each cockpit

Sample Manufacturing Information Requirements

1. Ply laminating sequence (stating which ply is the moulded face)
2. Ply materials
3. Ply weave styles
4. Ply material weight in grm/m² (dry weight ie. without resin)
5. Ply orientation (where 0° is parallel with the 800mm edges)
6. Core material and density in lbs/ft³ or kg/m³
7. Manufacturing method (stating vacuum, pressure and temperature)
8. A 100mmx100mm sample of all materials used (resin samples not required)

Samples as per sample construction requirements must be sent to the following address:

Siegfried Boettle
 1283 Blackburn Avenue
 60031 Gurnee, Illinois USA
 Tel. + 1 847 6235845 Fax + 1 847 6235826
 E-mail: ziggy@boettle.org

509.01

Any boat having a restraint system (driver harness) must have a reinforced cockpit complying with § 509, even if a reinforced cockpit is not mandatory in its class.

Matters relating to cockpits/deformable structures shall be dealt with by the cockpit working group.

Experts may be co-opted when required.

The manufacturer of any reinforced cockpit will submit his name, or company name if applicable, and completed U.I.M. reinforced cockpit questionnaire to his National Authority. and thence to U.I.M., before that cockpit will be allowed to compete. The manufacturer's name, type designation, date of manufacture and registration number must be permanently moulded into a visible place on or in the reinforced cockpit. If this is not moulded in, a scrutineer shall grind the UIM registration number, and the manufacturer serial number into the cockpit/midsection of the boat.

Cockpit structure must include securely attached flotation capable of floating the cockpit, driver, motor and any attached structure.

The National Authority of the manufacturer of the reinforced cockpit will receive an acknowledgement from the U.I.M. office.

In the case of series manufactured cockpits, the letter will refer to the cockpit manufacturer and type.

509.02 - PICKLE-FORKS

A boat is allowed to race in a re-started heat/race without a **deformable** pickle-fork, **only** if it has been lost during **the** stopped heat/race.

All catamaran type boats must comply with the following : The main body of the sponson must end in a minimum 100 sq.cm forward bulkhead made of a minimum 8 mm thick plywood or equivalent material. This bulkhead must be an integral part of the main

structure of the sponson and must have a rounded area of at least 10 cm length. See following sketch A.

The following will apply to outboard classes above 1500 cc, all other cockpit classes and any boat equipped with deformable pickle-forks.

Race boats of catamaran type, designed and equipped with pickle-forks, must have deformable and energy absorbing pickle-forks according to the following:

“The most forward end of the picklefork must be deformable and must be designed to crush.

“The deformation must start at a maximum of **100 kg**.

“The pickle fork must :

- be detachable and have nothing inside
- have a front end of minimum horizontal radius of 35 mm
- have of front end minimum radius of 20 mm in all other directions
“According to the following drawings”

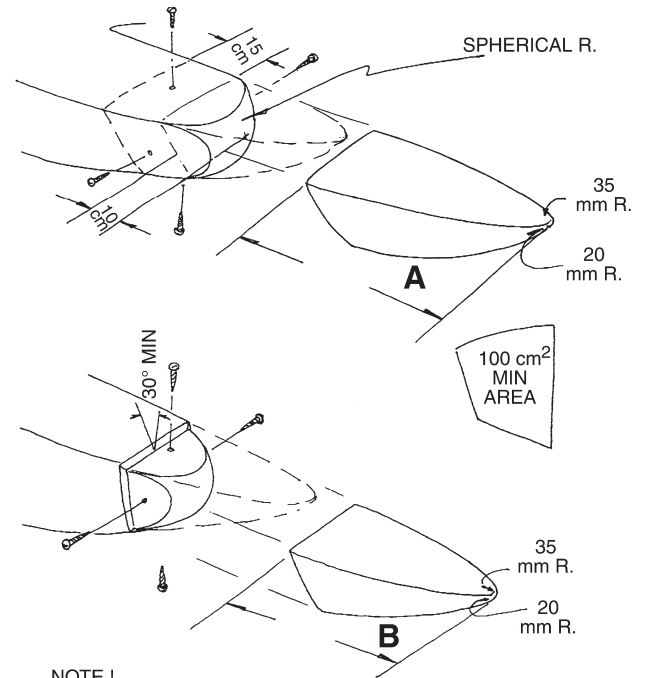

NOTE !

PICKLEFORK MUST DEFORM AT 140 kg MAXIMUM

FOR ALL FORMULA BOATS
EXCEPT F-500 DIMENSION
A=50cm B=35cm
THESE ARE MINIMUM
DIMENSIONS.

FOR ALL OTHER PICKLEFORK BOATS
A=40cm B=25cm
THESE ARE MINIMUM
DIMENSIONS.

The nose of the cockpit of boats built after January 1, 2001 must have the same minimum dimensions as the front of the sponsons before the collapsible picklefork.

If a collapsible front is used on the cockpit, it must have the same minimum dimensions as the picklefork.

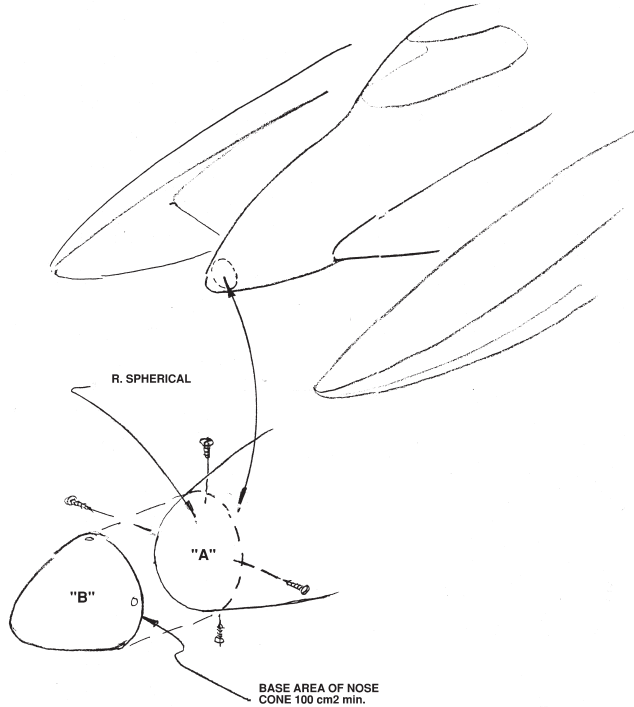

- A. The front of cockpit must have the minimum radius as the front of the main body of the sponson, before the crushable picklefork.
- B. A deformable nose may be added to the cockpit but it must be detachable, have nothing inside, have the same minimum dimensions as the detachable picklefork and deformation must start at a maximum of 140 kg.

509.03

Any competitor driving in an approved reinforced cockpit design boat will be in a restraint system consisting of a minimum 5 strap/4 point mounting design.

Not closing the belt in cockpit classes will result in a suspension for the 2 following races of the Series and for titled Championships run in one round, in a suspension at the next Championship.

Strap locations will be minimum two each hip, crotch, two-shoulder, all hooked together in a central release system. This release mechanism must remain released/open once it is activated and until it is reset. **A high strength, highly visible, lanyard will be attached to the release lever of the lever/latch system.** Belting shall be a minimum of 5 cm (2 in) width.

The driver harness attachments bolts in reinforced cockpits must consist of a minimum of 8 mm bolts, 1.25 thread, grade A4 and 3 mm stainless steel plate of 100 sq.cm per attachment point. There must be a spacer and a washer on the attaching bolt. The spacer must be glued into the cockpit.

It is mandatory for boats that the shoulder harness straps should be mounted to a metal channel spanning the backboard securely fastened to the sides of the centre section of the boat as shown in 509.18.

Boats manufactured starting from January 1st, 1997 will have to be provided with reinforced cockpit having the following minimal measures:

It is taken into account the need to leave around the body the volume necessary to absorb some slight deformation without remaining trapped into the cockpit:

- The length between the back rest and the base of the feet must be cm. 126 or more
- The height between the base and the roof of the cockpit for the race boat furnished with closed cockpit and seat shall be such that the minimum head clearance of 509.05 is maintained. The driver shall not be reclined more than 45 ° from the vertical.
- The width at the level feet must be cm. 28 for a cockpit with only two pedals or no pedals. If three pedals are required the minimal width must be cm. 36
- At knee level the width must not be less than cm. 40
- At hip level the width must be cm. 48 or more
- The vertical internal dimension at foot level must be cm. 33 or more
- The vertical internal height at knee level must be, in order to obtain an easily extraction of the pilot in case of accident, at least cm. 45
- The length of the opening in the cockpit for boats built after 1st January 2006 must not be inferior to cm. 65, and, a minimum width at some point, of 46 cm in order not to represent an obstacle to the extraction of the pilot
- The width at shoulder level, not less than cm. 56 from the lower point of the cockpit, must be cm. 48

If a homologated “integrated canopy structure” is used then the canopy must be fitted, closed and latched at all times while engaged in practice or racing.

509.04

A jacket with ballistic covering of orange colour having approximately 4.5 kg (10 lbs) flotation and equipped with epaulette type extraction loops on the shoulders and properly fitted to prevent being accidentally pulled over the head is mandatory.

Flotation overalls are a permitted alternative to life jackets, but must conform to all life jacket requirements (colour, buoyancy, protective plates, collar, etc.). The overalls must also include the cut resistant material required in rule 205.11.

509.05

Minimum 5 cm (2 in) clearance above driver's head (with 10 cm (4 in) recommended), covering at least 50 % of the top of the helmet and at least 50 % of the side of the helmet with the driver's head in the furthest aft position, as an integral part of the cockpit construction.

For new boats built after January 1st 2006, the cockpit should afford a minimum 5 cm (2in) clearance above the drivers head (with 10 cm – 4 in – recommended) and cover 50 %, +- 5 % of the top of the helmet and 50 % +- 5 % of the side of the helmet with the driver's head in the furthest aft position, as an integral part of the cockpit construction.

509.06

Minimum 12 mm (1/2 in) 4 kg (9 lbs) Ethofoam or other energy absorbing foam support completely around the inside of helmet area to prevent injury from helmet hitting cockpit. Acceptable free space for helmet is approximately 5 cm.

509.07

The top of the front of the cockpit will be a maximum of 10 cm (inch) below eye level, and so constructed as to deflect water away from the driver.

509.08

Energy absorbing foam padding is to be strategically placed inside the cockpit –limiting side-to-side head movement and areas where the knees, hands, etc., might impact.

In addition the Hans Device is highly recommended for F1 and is recommended for F2000, S2000, S3000.

Seats are mandatory for F1/**F2000** cockpits and strongly recommended for all other cockpit classes.

OBJECTIVE OF SEAT

Work with the restraint belts connecting driver's body securely to the cockpit, thus creating minimal movement between the cockpit and body.

Spreading of load over the body, reducing the chance of local loading and injury.

SEAT

Construction to be stiff and strong enough so that attachment to cockpit is secure and movement between any part of the seat and cockpit is minimal (less than 10 mm) in crash loading.

Closely fitted to the rear and side of each driver's shoulders, ribcage, pelvis and thighs (to at least midway from hips to knees).

Minimal padding that is sufficient for driver comfort while racing (typically 10 mm).

RECOMMENDED

Flat panels beside the legs, to reduce possible injury.

No exposed hardware, inside cockpit, which would come in contact with the driver, in a crash.

509.09

No sharp edges or protrusions anywhere inside or around the entryway of cockpit.

509.10

A removable steering wheel is mandatory.

The steering wheel must be easily removable without tools.

It is recommended that a centre pull ring type release (using only one hand) be used with detachable steering wheels.

509.11

Left and right rear-view mirrors are mandatory.

509.12 - MOTOR SHUT OFF SWITCH

All boats with reinforced cockpits will have an ignition shut- off switch for the motor, located on the left (port) outside of the cockpit. It will be clearly marked "MOTOR SHUT OFF SWITCH". Kill switch lanyard connections are not required on boats with reinforced cockpits.

Lanyard connection to the life vest is required to shut off the fuel on boats with electric fuel pumps.

509.13 - VISIBILITY IN COCKPITS

For boats built after 1st January 2006, the driver must have, when strapped in his cockpit, at least a free view of 180 degrees.

509.14

Air vents must be provided in the sponsons directly behind the pickle forks ahead of driver's seat of all catamarans : 2 x 20 cm² (3in²). These air vents can be behind the driving positions of V nosed boats and in the bow.

Airtight compartments in the aft end of racing boats are prohibited.

Catamaran boats fitted with airbag systems require air vents to be fitted either behind the pickle forks but ahead of the drivers seat or between the sponson and the cockpit forward of the driver to all catamarans.

The size to be 2 x 20 cm² (2 x 3 in²) min.

RECOMMENDED FOAM FLOTATION (see § 503.01) AND AIR VENTS LOCATION

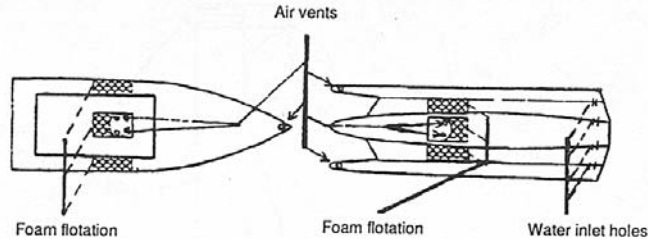

509.15

Water inlet holes on catamarans as shown in the sketch must be in the rear of the centre section fore and aft sides.

These holes must be at least 40 sq. cm (6 sq. in) in an area each side and communicate with air space inside the sponson. Any communicating holes in intervening bulkheads must be the same size. Air/water must be able to pass freely from these holes to air vents in the upper front of the sponson/boat.

509.16

All windscreens will be shatterproof material. All reinforced cockpit canopies shall have an external handle or hand hold opening to facilitate the opening of the canopy.

The following requirements are specified for reinforced cockpit canopies (For F1, mandatory for new construction after January 1, 2005. For S3000, F2000 (S2000), mandatory for new construction after January 1, 2006:

1. Canopy windscreen/window material and shapes shall be a minimum of (8mm) polycarbonate material of high optical grade with scratch resistant outer coating. Such canopy shapes, forms, and materials are available, for example, from Formtech Plastics Inc., USA +1 800 860 7572.
2. All canopy support inner and outer frames, "U" and "H" channels, shall be constructed of a minimum of 2000 grams of "S" glass and/or Kevlar and bonded utilizing epoxy resin.
3. If the polycarbonate canopy frames are not glued, the frames shall be affixed thru-bolted utilizing bobbins/sleeves made of nylon, delrin, aluminium, or other material so as to not directly cause clamping forces to the polycarbonate material by thru-bolts. Bolt spacing shall be no greater than every 5 cm and shall incorporate the use of 6mm diameter (minimum) stainless steel bolts. All bolts shall utilize stainless steel nylock or acorn nuts with washers. No bolt threads or sharp edges shall endanger the driver in the interior of the cockpit.
4. All canopy hatches, lids, and caps shall be constructed of a minimum of 12 mm foam or balsa core material of 3 kg density laminated with 2000 grams of "S" glass and/or Kevlar bonded with epoxy resin.
5. It is recommended that All polycarbonate material should be able to withstand the loads consistent with a minimum of a 350 knot, 4 pound bird strike test as employed by Texstar Inc., USA, manufacturers of the F-16 canopy. Such tests may be specified by UIM at a future point in time. **International standard tests like DIN 52290 ; BS 5444 ; ISO 179. For impact strength and compliance.**
6. All outer edges of canopies and hatches shall be protected from water intrusion leading to possible failure by the use of water deflectors, frames, or channels.

7. All canopy or hatch openings which allow access to the cockpit or driver shall include provision for a slot and pry bar pad to be utilized by rescue in the event of jamming or failure.
8. All canopy structures, hardware hinges, mechanisms, construction techniques and installation methods are subject to approval by the cockpit commission.
9. For the purpose of the development of an integrated canopy structure, the UIM cockpit Committee can determine that rules 509.05, 509.06 and 509.07 do not apply under the condition that the manufacturer certifies in regard of the canopy:

The sufficient strength of the construction and at a minimum equal strength and integrity to existing cockpit/canopy systems.

That the canopy passed all tests foreseen in this rulebook.

The driver of such cockpit must declare in writing, that he is aware to drive such experimental cockpit under this rule. Such construction may race for a maximum period of 2 years without further homologation in the rulebook.

This permission can be withdrawn by the UIM cockpit Committee for safety reasons.

All hinges attached to a reinforced cockpit canopy must have pins easily pulled out, and utilise pull rings or knobs, accessible both externally (for diver) and by the driver below the closed canopy.

Mandatory for F1, S3000, F2000 and S2000.

The following minimum specification is required for canopy hinges:

- a. The canopy safety hinge shall be manufactured of stainless steel.
- b. The minimum length of the hinge shall be 10 cm overall.
- c. The minimum width of the hinge shall be 3 cm.
- d. The minimum thickness at the mounting surface shall be 3 mm with 3 fasteners at the end.
- e. The pivot point shall be a fixed 6mm diameter axle pin and shall not be a quick release point of the hinge.
- f. A secondary quick release pin of the push/pull type with a minimum

6 mm diameter shall be incorporated in such a manner as to enable the hinge to be easily released by rescue personnel.

- g. The secondary push/pull shall include a drive out pin feature, as well as a stainless steel pull ring.
 - h. The design of the hinge shall prevent the binding of the quick release pin in the event of an incident requiring its removal.
10. Canopy latches or closers must be designed to keep the canopy closed during an accident.

509.17

It is recommended that in a reinforced cockpit there is an opening of 60 sq. cm (9 sq. in.) above the helmet so as to reduce the hydraulic effect on the driver in case of an accident.

For old and new cockpits the reinforced cockpit backboard behind the driver shall be at a minimum the same strength as the sides of the reinforced cockpit. The lay up schedule and bonding mechanism shall be defined in the reinforced cockpit registration questionnaire.

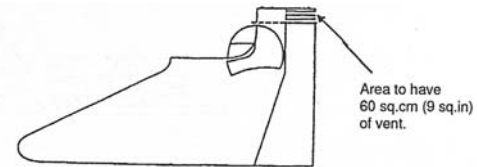

509.18

These are the mandatory requirements for the placing of seat belts and shoulder harness to be used in a reinforced cockpit: Any substitution system must be approved by Safety Cockpit Committee.

Shoulder harness should be installed 90° to spine at shoulder line to minimize compression injuries under high "G" loading.

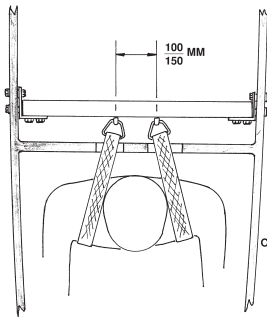
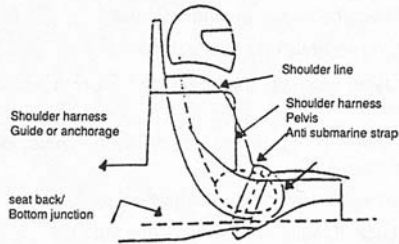

BAR MUST BE INSTALLED DIRECTLY AGAINST THE BACKBOARD OR AGAINST A FULL LENGTH SPACER BETWEEN THE BACKBOARD AND THE BAR.

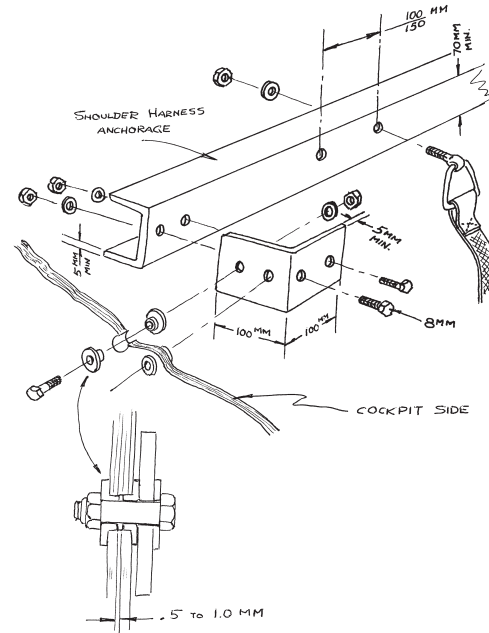

509.19

To assist rescue crews, cockpit boats must have the bottom of that part of the cockpit containing the driver or all materials covering the bottom of the cockpit painted international orange and labelled in the centre with 30 cm (12 in) letters for the boat number, and 10 cm (4 inch) letters specifying other critical information such as: breathing apparatus (BrA), head restrain (HsD), etc. With breathing apparatus means only breathing equipment that automatically serve an unconscious driver with breathing air. Not the "spare air" type that must be handled by the submerged driver.

GUIDELINES FOR INSPECTION OF REINFORCED COCKPITS.

- Check manufacturers ID plate and registration number.
- Check buoyancy behind bulkhead.
- Check seatbelts for wear, attachment points and release systems. (Check for corrosion, lack of maintenance, lubricated release system etc.)
- Check removable steering wheel systems. (Lack of maintenance, lubrication etc.)
- Have the driver to put on all safety equipment and get into the cockpit. Fasten all seatbelts, put steering wheel on, cover drivers visor and check to see that the driver can release him/herself.
- Check that the driver fits inside the cockpit as described in §509.05.
- Check water deflector as in §509.07 on cockpit top front.
- Check for sharp edges and energy absorbing foam inside cockpit.
- Check left and right rear view mirrors.
- Check air vents. As in §509.14
- Check water inlet holes in back of boat centre section
- Check bottom of cockpit for orange colour and boat number.
- Check function and position of MOTOR SHUT OFF SWITCH.

These guidelines are only as a help to the scrutineers of reinforced cockpits.

509.20 - AIR SUPPLY

The driver must have air available as either “Spare air” or air which is supplied continuously to the driver.

The air bottle is to be fully charged prior to the time trials and racing. This air supply bottle may be carried on the driver or securely mounted in the boat. It is the responsibility of the driver to have a fully charged bottle prior to the time trials or race. The regulator shall work in any position.

510 - RACING INBOARDS (R)

511 - CLASSES

R 1000	cylinder capacity of the motor up to 1000 cc incl.
R 1500	cylinder capacity of the motor from 1001 to 1500 cc incl.
R 2000	cylinder capacity of the motor from 1501 to 2000 cc incl.
R 2500	cylinder capacity of the motor from 2001 to 2500 cc incl.
R 5000	cylinder capacity of the motor from 2501 to 5000 cc incl.
R 7000	cylinder capacity of the motor from 5001 to 7000 cc incl.
R ∞	cylinder capacity of the motor from 7001 to infinity

512 - HULL

512.01

The hull design is free.

512.02

Any device to produce a sudden braking effect, causing excessive water spray reducing visibility, is forbidden.

512.03 - MINIMUM DIMENSIONS

Class	Weight	Length	Reinforced cockpit
R 1000	300 kg	4.20 m	mandatory
R 1500	350 kg	4.50 m	mandatory
R 2000	390 kg	4.80 m	mandatory
R 2500	420 kg	5.10 m	mandatory
R 5000	600 kg	5.70 m	mandatory

R 7000	700 kg 6.10 m	mandatory
R ∞	800 kg 7.00 m	mandatory

- 1) The minimum weights mentioned above are the weight of a complete rig weighed directly after the race without driver, or residual water but including the residual fuel.
- 2) Measurements are taken while the boat is ashore.

The length must be measured as the overall length of the hull between perpendiculars at the foremost and aft most rigid part of the hull.

Any extending parts, rubbing starches, fenders, stabilising and trim tabs and rudder are not to be included.

513 - MACHINERY

513.01

The motor is free.

The motor must be fixed inside the hull.

The power transmission train must pass through the structure of the hull.

All modifications are allowed.

513.02

Only one propulsion device is allowed and the total effort must be applied to the water.

513.03

When the propulsion is of the water jet type, the jet may be ejected in the air.

513.04

An electric starter and battery must be on board.

513.05

The transmission is free.

514 - FUEL

See 508.01, 508.03, 508.06, 508.07, 508.08, 508.09, 508.10, 508.11.

515 - RACING INBOARD - HISTORIC (H.R.) - FORMULA R 1000

516 - CLASSES

Formula R 1000 cylinder capacity of the motor up to 1000cc incl. (for old Wartburg engines max capacity is 1020 cc).

Minimum weight hull only 200 kg

Minimum weight with driver 280 kg

HR 2000 Cylinder capacity from 1001 cc. to 2000 cc. included.

Cockpits are required for the HR 2000 only.

517 - HULL

517.01

The hull must be of a hydro type (the sponson should not exceed 60% of the total length of the hull).

Pickle forks: as per 509.02.

Either a reinforced cockpit or side protection as per rule 522.02, even if the driver is in a sitting position. If in a sitting position the reinforcing must extend up to approximately the driver's shoulder height and forward to approximately the driver's feet.

517.02

Any device to produce a sudden braking effect, causing excessive water spray reducing visibility, is forbidden.

518 - MACHINERY

518.01

Only naturally aspirated reciprocating carburetted boat, motorcycle or motor car engines older than 10 years, are permitted. ***Engines must have been manufactured at least 10 years ago.***

It will be the responsibility of the driver to prove the eligibility of the engine.

The drive line between engine and propeller to be basically straight (no Z drives). A gearbox may be attached at the motor however it is forbidden to change the gears while racing.

518.02

For HR 2000 cc. only automobile motors built before 1987 are allowed.

519 - FUEL

See 508.01, 508.03, 508.06, 508.07, 508.08, 508.09, 508.10, 508.11.

520 - RACING OUTBOARDS (O)

521 - CLASSES

- O 125 cylinder capacity up to 128 ccs
- O 175 cylinder capacity up to 175 ccs incl.
- O 250 cylinder capacity up to 250 ccs incl.
- O 350 cylinder capacity up to 350 ccs incl.
- O 500 cylinder capacity up to 500 ccs incl.
- O 700 cylinder capacity up to 700 ccs incl.
- O 850 cylinder capacity from 701 up to 850 ccs incl.
- O 1000 cylinder capacity of the motor from 851 up to 1000 cc incl.
- O 1500 cylinder capacity of the motor from 1001 up to 1500 cc incl.
- O 2000 cylinder capacity of the motor from 1501 up to 2000 cc incl.
- O 3000 cylinder capacity of the motor from 2001 up to 3000 cc incl.
- O ∞ cylinder capacity of the motor from 3001 cc to infinity.

522 - HULL

522.01

For O 125, O 175, O 250 and O 350 the hull must be only of Hydroplane type with a maximum sponson length of 60 % of the total length of the hull.

Any longitudinal air entrapment structures on either side of the hull behind the sponsons must be less than 40 mm deep at the transom. They must not extend beyond a straight line drawn from the rear lower point of the transom and the point 40 mm below the bottom of the transom (measured from a straight line across the boat at the transom as shown on the sketches).

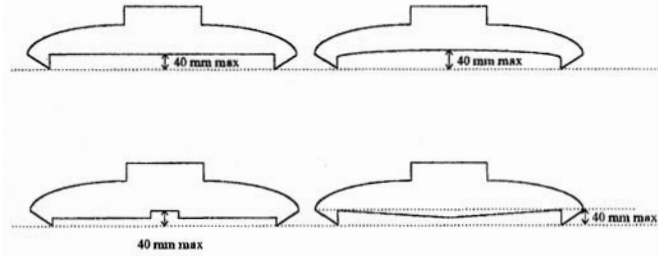

For the classes O 500 to O ∞ , the hull design is free.

522.02

All hydroplane hulls in classes **O 125**, **O 175**, O 250, O 350, OSY 400 must have re-inforced side protection as shown in the sketches.

For O.125 and O.175 classes, above will be implemented as from January 1, 2008.

All dimensions are minimum unless stated. Measurements taken from inside of hull from solid floor on which the driver lays or kneels (no cushions). Reduction to the front side panel is permitted for vision or to have vision panel installed.

On kneelers the amount of cut out to keep stabilisation is as per drawings and no reduction at front.

Reinforcing must be two layers of 315 grm Aramid Fibre (Kevlar) or comparable material.

This should be bonded to clean wood free of varnish paint etc.

All hydroplane hulls with pickle forks must have sponson leading edges of a rounded surface of at least 50 mm diameter in one direction. If extensions of the pickle forks are used, it must have deformable pickle forks for a minimum length to give an exposed rounded surface when removed of at least 50 mm diameter in one direction.

KNEELERS

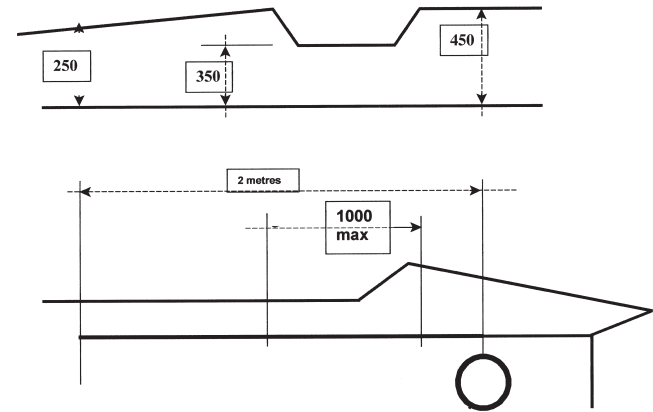

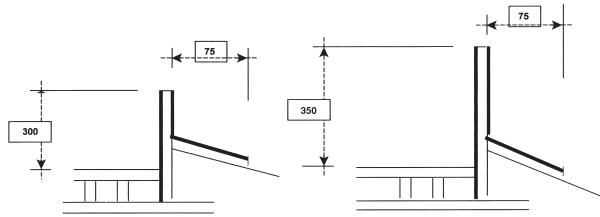

Sections B

Section A

2 layers
315gms
Aramid fibre or
comparable

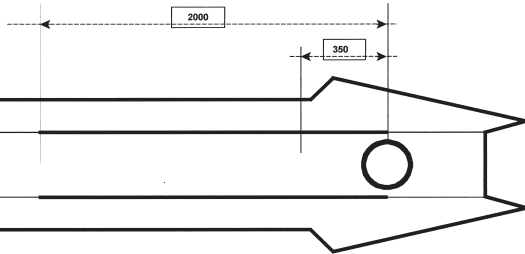
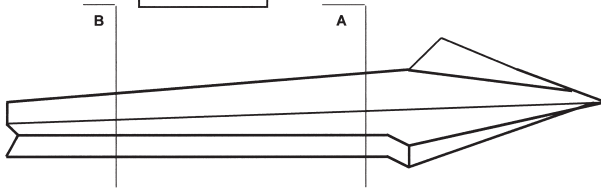

522.03

Any device to produce a sudden braking effect, causing excessive water spray, reducing visibility, is prohibited.

522.04 - MINIMUM DIMENSIONS

Class	Minimum Weight Hull only	Minimum Weight with driver	Reinforced cockpit
O 250	120 kg	190 kg	
O 350	130 kg	210 kg	mandatory *
O 500	180 kg	260 kg	mandatory
O 700	180 kg	260 kg	mandatory

Class	Weight	Length	Reinforced cockpit
O 850	250 kg	3.90 m	mandatory
O 1000	300 kg	4.20 m	mandatory
O 1500	350 kg	4.50 m	mandatory
O 2000	390 kg	4.80 m	mandatory
O 3000	450 kg	5.10 m	mandatory
O ∞	520 kg	5.30 m	mandatory

* Only for boats with a sitting driver (steering wheel over body, legs or feet)

- 1) The minimum weights mentioned here above are the weight of a complete rig weighed directly after the race without driver, residual water but with residual fuel.
- 2) Measurements are taken while the boat is ashore.

The length must be measured as the overall length of the hull between perpendiculars at the foremost and aftmost part of the hull including deformable pickle-forks **if so designed and equipped**.

Any extending parts, rubbing starches, fenders, stabilising and trim tabs and rudder are not to be included.

523 - MACHINERY

523.01

The motor is free except Class O 125 which is restricted to single cylinder only.

An outboard motor is a mechanical propulsion assembly which can be removed from the boat as a single unit, complete with its transmission, and which does not transmit the power through the hull at any point. Any mechanism intended to modify the angle of attachment and/or the height of the motor is authorised.

The motor thus taken off and placed ashore must be capable of being started, fed by its fuel tank.

The mounting supports fixed to the boat, the control levers, the tachometer with its connections, the battery with its conductors and the fuel tank and fuel lines do not form part of the power unit.

523.02

Only one propulsion device is allowed and the total effort must be applied to the water.

523.03

When the propulsion is of the water jet type, the jet may be ejected in the air.

523.04

The transmission is free.

523.05

All un encased outboard motors with capacitor discharged ignition shall have a flywheel guard.

524 - FUEL

See 508.05, 508.06.

525 - CLASS OSY 400

526 - CLASS OSY R

OSY R is a junior class conforming with UIM rule 527-529, for OSY 400.

In addition to rule 527 – 529, engines in OSY 400 should have a UIM air restrictor. Minimum age drivers as from 14 years old and limited to 18 years old.

527 - HULL

527.01

The hull must be of a hydro type (the sponson must not exceed 60% of the total length of the hull).

Minimum weight hull only 100 kg

Minimum weight with driver **180** kg

527.03

A reserve of visible and sufficient flotation must be provided to keep the hull floating in case of accident. (see § 503.01)

527.05

Any device to produce a sudden braking effect, causing excessive water spray, reducing visibility, is prohibited.

528 - MACHINERY

Any machinery aimed at modifying the motor attachment angle and/or the height of the motor while the motor is running is forbidden.

528.01

The motor must be a Yamato model 102, 202 or 302 series duly homologated by U.I.M.

528.10 - SOLE MODIFICATIONS ALLOWED

- 1) It is permissible to use any ignition wire, spark plugs, propeller nut.
- 2) It is permissible to drill water drain holes in the ignition castings (coil plates and crankcase end cap) and these holes may be tapped and plugged.
- 3) It is permissible to use any fuel line or fittings providing threads in tank and carburettor are not changed. A fuel filter may also be used.
- 4) It is permissible to enlarge the gas tank by cutting it apart at the seam and adding at least 2" band (2" will give one third of a gallon more) or may build a complete tank, but it must be mounted the same as the original. The tank mount plate may not be modified.

- 5) A fuel pipe may be used for marathon racing but the hole in the crankcase must be plugged when racing same motor in closed course.
- 6) Bolt threads may be repaired by tapping oversize or use of helicoils.
- 7) Broken parts may be repaired by welding or use of plastic compound, if all contours remain the same.
- 8) Any water flow restrictions are permitted.
- 9) No polishing or removal of metal on any internal passages or carburettor, intake manifold, or tuned exhaust system.
- 10) No polishing or balancing of reciprocating or rotating parts.
- 11) Any type of thrust bracket adjustment is allowed providing no alterations are made to the motor and may not be adjustable while boat is moving.
- 12) The tilt lock lever may be removed and the spacer on the tilt bracket bolt.
- 13) The holes in steering bar may be drilled larger for attaching steering cable.
- 14) Any device may be used to hold spark lever in advance position.
- 15) Spray shield may be modified to use throttle cable, and for choking carburettor.
Where a hole is in the side it must not exceed 30 mm in diameter or equivalent area.
- 16) The propeller shaft may be turned down to fit any propeller.
The propeller is free
- 17) The use of non-Yamato parts are forbidden.

- 18) Measurements not quoted in the homologation sheet may not be altered. If a detail cannot be verified with the aid of the pictures in the homologation sheet, the part in question can be compared to corresponding stock part. In such a comparison it is only possible approximately to use the comparable measurements as the manufacturing tolerances are not available.
- 19) The driver is responsible for the condition of the engine as raced. Errors on the part of one manufacturer, mechanic or previous owner is no excuse.
- 20) Shorting switch is mandatory (i.e. jack plug).
- 21) Oversize pistons allowed to first over-bore only (max.bore size: 2.622 or 66.59 mm e.g. 66.50 + 0.09 mm)
- 22) Any type, size or make of nut, bolt, screw, washer may be used except for butterfly screw which must be standard.
- 23) Painting - it is permissible to paint any part of engine and accessories any colour.
- 24) Any holes can be drilled to safely attach engine to the hull.
- 25) A part from the above provisions, it is absolutely forbidden to make any alterations to the engine manufacturers standard components either by removal or addition of material. In particular this includes components being subjected to any form of machining, grinding, hand tooling, reworking, reshaping, fettling, polishing etc. unless it is specifically permitted.
- 26) Plug caps may be changed.

529 - FUEL

See 508.01, 508.02, 508.06, 508.07, 508.08, 508.09, 508.10, 508.11.

530 - SPORT INBOARDS (E)

531 - CLASSES

E 1000	cylinder capacity of the motor to 1000 cc incl.
E 1500	cylinder capacity of the motor from 1001 to 1500 cc incl.
E 2000	cylinder capacity of the motor from 1501 to 2000 cc incl.
E 2500	cylinder capacity of the motor from 2001 to 2500 cc incl.
E 5000	cylinder capacity of the motor from 2501 to 5000 cc incl.
E 7000	cylinder capacity of the motor from 5001 to 7000 cc incl.
E ∞	cylinder capacity of the motor from 7001 to infinity

532 - HULL

532.01

The hull design is free.

532.02

Any appendage intended to lift the boat by an aerodynamic effect is prohibited. Hydrofoils are not allowed.

532.03

Aboard inboard craft, the motors must be housed in a covered compartment or situated under the deck but adequately and efficiently ventilated.

Transmission links and all moving parts liable to cause injury or accident must be efficiently guarded.

532.04

Any device to produce a sudden braking effect, causing excessive water spray, reducing visibility, is prohibited.

532.12 - MINIMUM DIMENSIONS

Class	Weight	Length	Reinforced cockpit
E 1000	300 kg	4.20 m	mandatory
E 1500	350 kg	4.50 m	mandatory
E 2000	390 kg	4.80 m	mandatory
E 2500	420 kg	5.10 m	mandatory
E 5000	600 kg	5.70 m	mandatory
E 7000	700 kg	6.10 m	mandatory
E ∞	800 kg	7.00 m	mandatory

1. The minimum weights mentioned here above are the weight of a complete rig weighed directly after the race without driver, or residual water but with residual fuel.

2. For all series mentioned above:

Measurements are taken while the boat is ashore.

The length must be measured as the overall length of the hull between perpendiculars at the foremost and aftmost part of the hull including deformable pickle-forks.

Any extending parts, rubbing starches, fenders, stabilising and trim tabs and rudder are not to be included.

533 - MACHINERY**533.01**

The motor must be fixed inside the hull.

The power transmission train must pass through the structure of the hull.

533.02

Marine motors homologated by U.I.M. as having been built in series, that is with all identical and interchangeable parts and fitted ready for running, with a minimum number of 30 motors produced.

533.03

The marine inboard motor is a mechanical assembly producing power, specially designed and manufactured for the propulsion of boats and which is catalogued and sold by an industrial firm.

533.04

The motor must be ready to function, and must include the following items:

- all the accessories required for the functioning and regulation of the cooling system,
- an oil cooler,
- the motor installation mounts,
- the starting device and a generator for recharging the battery.

533.05

The gear box and the exhaust manifold do not form a part of the motor.

533.06

Only one propulsion device is allowed and the total effort must be applied to the water.

533.07

Only automobile motors homologated by the Federation Internationale de Sport Automobile as laid out in the general list of FISA homologated cars in group N + A are allowed.

Group N: Production cars

Group A: Touring cars

533.08

No other automobile motors homologated by the F.I.A. are allowed for powerboating.

533.09

The alterations allowed by F.I.S.A are not allowed in motor boating. Only the alterations listed in Article hereunder are allowed.

533.10 - SOLE MODIFICATIONS ALLOWED

1. The replacement of the dynamo by an alternator is allowed provided that the securing points of the replacing accessory and its driving system remain unchanged.
2. The fitting of a transistorised ignition system is allowed, provided that no mechanical part of the motor is altered.
3. For U.I.M. or F.I.S.A homologated motors reboring is allowed provided the total cylinder capacity does not exceed the limits that have been provided for the class in which the motor has been homologated.
4. The air filter can be taken out or altered.
5. Dynamic air intakes can be fitted to the carburettors.
6. The mechanically operated fuel pump may be exchanged with an electrically operated fuel pump, without obligation to keep the original location.

7. An oil filter and/or a radiator may be added when not provided by the manufacturer. The original(s) may be changed.
8. The carburettor(s) fitted by the manufacturer may be replaced by one or more carburettors or by a fuel injection system provided they can be fitted without altering the cylinder head.
9. The modification or replacement of the intake manifold is allowed.
10. The valve springs may be replaced by others from any origin, but without modification of the number fitted by the manufacturer and provided they can be fitted without any modification to the original brackets.
11. Pistons are free.
12. The camshaft(s) is (are) free.
13. Increasing the compression ratio by polishing the cylinder head (or using a thin gasket or the suppression of the latter) is allowed.
14. Any tuning operation such as polishing the original parts but not replacement of same, except for pistons, the springs and the cam shafts as specified above, are allowed.
15. In other words, provided it is always possible to establish indisputably the origin of a mass produced part, this component may be rectified, balanced, adjusted, its form reduced or changed by brightening, excluding any addition of material, any mechanical extension or any treatment modifying the characteristics of the molecular structure of the metal surface.

533.11 - ELECTRIC STARTER

An electric starter and its battery are required on board, as well as a device for recharging the battery.

533.12 - TRANSMISSION

Reverse gear is compulsory.

The transmission is free.

Going astern must be obtained by reversing the rotation of the transmissions which supply the propulsive effort. In waterjet propelled boats, the astern movement is obtained by diversion of the waterjet.

The control handle for reverse gear, ready for use, must be within hand reach of the driver. Astern manoeuvring of the boat must be possible by the action of reverse gear solely.

533.13

Only one propulsion device is allowed and the total effort must be applied to the water.

534 - FUEL

See 508.01, 508.02, 508.06, 508.07, 508.08, 508.09, 508.10, 508.11.

540 - SPORT OUTBOARDS (S)

541 - CLASSES

- S 175 cylinder capacity of the motor to 175 cc incl.
- S 250 cylinder capacity of the motor from 176 to 250 cc incl.
- S 350 cylinder capacity of the motor from 251 to 350 cc incl.
- S 550 cylinder capacity of the motor from 351 to 550 cc incl.
- S 750 cylinder capacity of the motor from 551 to 750 cc incl.
- S 850 cylinder capacity of the motor from 751 to 870 cc incl.
- S 1000 cylinder capacity of the motor from 871 to 1000 cc incl.
- S 1500 cylinder capacity of the motor from 1001 to 1500 cc incl.
- S 2000 cylinder capacity of the motor from 1501 to 2000 cc incl.

- S 3000 cylinder capacity of the motor from 2001 to 3000 cc incl.
- S ∞ cylinder capacity of the motor from 3001 to infinity

SL 60 60 hp

***SL 90 90 hp**

***SL 250 250 hp**

***SL 90 : Class will be implemented as from January 1, 2008 onwards**

***SL 250 : Class recommended in 2007. Will be implemented as from January 1, 2008 onwards**

541.01 - LOW EMISSION ENGINES

In order to compete with parity in S.2000 class, low emission engines complying with 2006 EPA regulations will be allowed 30 % greater cylinder capacity (2600 cc). In addition, the effect of any air compressor used in support of and as part of the fuel injection system, shall be ignored in determining class displacement.

In order to compete with parity in S.3000 class, low emission engines complying with 2006 EPA regulations will be allowed 30 % greater cylinder capacity (3900 cc). In addition, the effect of any air compressor used in support of and as part of the fuel injection system, shall be ignored in determining class displacement.

For classes SL 60, SL 90 and SL 250, only engines conforming to EPA regulations are admissible.

541.02 - LOW EMISSION ENGINES

In order to compete experimentally in S.850 class, low emission engines complying to 2006 EPA regulations will be allowed 20 % greater cylinder capacity (1020 cc). In addition, the effect of any air compressor used in support of and as part of the fuel injection system, shall be ignored in determining class displacement.

542 - HULL

542.01

Only catamarans are permitted from class S 550 onwards.

542.02

Any appendage intended to lift the boat by aerodynamic effect is prohibited. Hydrofoils are not allowed.

542.03

In S2000, S3000, S infinity, **SL 250** and endurance 2 + 3, the homologated delayed operation buoyancy airbag is mandatory for all boats with sponsons constructed of composites (foam construction sandwich).

542.05

Any device to produce a sudden braking effect, causing excessive water spray, reducing visibility, is prohibited.

542.12 - MINIMUM DIMENSIONS

Class	Weight	Length	Reinforced cockpit
S 550	260 kg	3.70 m	_____
S 750	280 kg	3.90 m	_____
S 850	330 kg	3.90 m	mandatory
S 1000	380 kg	4.20 m	mandatory
S 1500	430 kg	4.50 m	mandatory
S 2000	470 kg	4.80 m	mandatory
S 3000	530 kg	5.10 m	mandatory
S ∞	600 kg	5.30 m	mandatory
SL 60	330 kg	3.90 m	Yes

*** SL 90 460 kg 4.60 m Yes (3000 ns)**

*** SL 250 570 kg 5.20 m Yes (3000 ns)**

*** Class SL 90 is recommended in 2007 and will be implemented as from January 1, 2008**

*** Class SL 250 is recommended in 2007 and will be implemented as from January 1, 2008**

1. The minimum weights mentioned here above are the weight of a complete rig weighed directly after the race including driver, personal safety equipment, residual fuel but without residual water.
2. Measurements are taken while the boat is ashore.

The length must be measured as the overall length of the hull between perpendiculars at the foremost and aftmost rigid part of the hull **including deformable pickle-forks if so designed and equipped.**

Any extending parts, rubbing stiches, fenders, stabilising and trim tabs and rudder are not to be included.

543 - MACHINERY

543.01

An outboard motor is a mechanical propulsion assembly which can be removed from the boat as a single unit, complete with its transmission, and which does not transmit the power through the hull at any point. Any mechanism intended to modify the angle of attachment and/or the height of the motor is authorised.

The motor thus taken off and placed ashore must be capable of being started, fed by its fuel tank.

The mounting supports fixed to the boat, the control levers, the tachometer with its connections, the battery with its conductors and the fuel tank and fuel lines do not form part of the power unit. Only single motor is permitted.

543.02

To be homologated as a sports motor, an outboard motor must be sold and advertised by an industrial firm as being manufactured in standard production series (that is to say with all parts interchangeable and with identical dimensions and materials with the equivalent part in another motor of the same model.) for the propulsion of boats.

To have homologation approved the numbers verified as in 505.01 must be:

up to 1000cc 1000 complete units

1001cc - 2000cc

- 500 units, 25 of which may be fitted with midsection, brackets and gearcases as in § 543.07.

2001cc and upwards

- 250 units, 25 of which may be fitted with midsection, brackets and gearcases as in § 543.07.

543.03

A sports outboard motor must be able to run at a reduced speed.

543.04

When the motor is in the water, the cooling must be effected by the homologated water circulation pump.

543.05

An efficient gear changing system giving forward, neutral and astern movement is compulsory for motors up to and including 1000cc capacity. The control handle for reverse gear, ready for use, must be within easy hand-reach of the driver when he is in the normal driving position. Manoeuvring of the boat astern must be possible by selecting reverse gear.

The casing of the underwater unit (gearcase) is free. All internal parts referred to on the homologation file must be maintained. Should the homologation provide for it, the exhaust will be a propeller exhaust.

543.06

All lower unit exhaust openings must remain standard within the homologated size.

543.07

For motors 1001cc capacity and above, forward, neutral and reverse gear are not compulsory. Such fixed gear versions are not necessarily intended for sale to or be used by general non-racing public. However, they must be available as an integral part of the complete outboard motor and homologated as such. The mounting brackets, midsection including exhaust pipes and gearcase, together with any parts required to fit these, must retain the dimensions specified on the homologation form.

543.08

An electric or manual starter must assure a quick and easy start without external aids. It must be used as it was supplied by the manufacturer, no adjustment or alteration being allowed.

543.10 - SOLE MODIFICATIONS ALLOWED

1. All studs, screws, nuts, bolts and their washers are free as well as the method of locking them.
2. The original propeller may be replaced by another. Gearcases with a propeller exhaust must use propellers equipped with an exhaust tube of a diameter at least that of the machined recess into which the standard propeller boss fits at the rear of the gearcase. The length of this tube must be at least $1/2 (Q - P)$, where Q and P are the dimensions shown on the sketch of the underwater unit on the homologation file;
3. The trim tab may be altered or removed to accommodate a propeller;
4. The cooling must be provided by the water pump;
5. Thermostats and pressure valves of the cooling system may be removed;
6. The steering mechanism may be altered. If the original steering bar is removed or new ones are installed, any openings created must be sealed to prevent the motor from pulling in additional air;
7. The swivel bracket may be altered for the purpose of installing a power trim and/or a power lift and the dampers (shock absorbers) may be altered or removed;
8. The rubber mounts of the motor may be altered, removed or replaced;
9. Revolution counters, water temperature gauges, water pressure gauges and similar instruments, can be installed;
10. Revolution limiters may be removed;
11. The gear interlock device on the starter may be removed;
12. Spark plugs are free.
13. Original carburettor jets may be replaced for another size;
14. Springs may be added to the throttle lever of the carburettors;

15. Re boring is allowed, but only piston assemblies supplied by the manufacturer of the motor may be used within the cc limit of the class;
16. A part which is dimensioned in the homologation sheet may be machined for the purpose of reaching that specific measure;
17. A part may be machined to attain the weight quoted in the homologation sheet without altering other criteria given for the part in question. It is not allowed to change the flywheel but balancing machining is allowed if the dimensions and weights provided for on the homologation sheet are respected;
18. Measurements not quoted in the homologation sheet shall only be checked by visual comparison with standard parts. As the actual manufacturing tolerances are not published, small differences between the inspected part and the reference part must be accepted.
19. The fuel connector in the lower cover may be removed and the fuel hose from the fuel tank connected directly to the fuel pump. If this is done the opening left after the connector and around the fuel hose must be sealed to prevent extra air entering inside of cover.
20. Electric fuel pumps may be added provided the fuel still runs through the original fuel system and no parts are removed or blocked off.
21. No parts may be added to the motor unless specified in this rule.
22. It is allowed to extend the starter cord of a rewind starter so that the starting handle can be reached from the cockpit

543.11 - MODIFICATIONS NOT PERMITTED ON LOW EMISSION ENGINES

1. Blueprinting of the powerhead is not permitted, equivalent to F2000/SST 120 classes.
2. Alteration or removal of any powerhead components is not permitted.
3. Electrical components and control system performance must remain standard

The following rules are NOT applicable to low emission engine:

543.10 Section: 5, 10, 13, 16, 17 and 20

502.02 Section: 3 and 2, last sentence not valid (Only adjustments to meet dimensions in the homologation sheet are allowed)

544 - FUEL

See 508.01, 508.02, 508.06, 508.07, 508.08, 508.09, 508.10, 508.11.

550 - MONOHULL OUTBOARDS (T)

General: The purpose is to limit this class to simple monohulls easily built by an amateur or readily available commercially, each fitted with one single homologated “stock” motor, available on standard sale.

551 - CLASSES

JT250 cylinder capacity of the motor to 265 cc incl.

T 250 cylinder capacity of the motor to 265 cc incl.

T 400 cylinder capacity of the motor from 251 cc to 400,5 cc incl.

T 550 cylinder capacity of the motor from 401 cc to 550 cc incl.

T 750 cylinder capacity of the motor from 551 cc to 750 cc incl.

T 850 cylinder capacity of the motor from 751 cc to 870 cc incl.

551.01 - LOW EMISSION ENGINES

<i>Class</i>	<i>hp</i>	<i>Weight</i>	<i>Length</i>	<i>Cockpit depth</i>
GT15	15 hp	210 kg	3.10 m	0.35 m
GT30	30 hp	250 kg	3.50 m	0.40 m

GT60* **60 hp** **350 kg** **4.00 m** **0.40 m**

GT90* **90 hp** **425 kg** **4.50 m** **0.40 m**

*** plus powertrim as manufactured**

Weight is including driver.

Engines :

Low emission engines complying with 2006 EPA Regulations will be allowed only. In GT60, GT90, integral powertrim is allowed (as manufactured).

The following modifications are expressly not permitted :

- Alteration or modification of any powerhead components

- Removal of material from the powerhead for any reason other than recognised (by the manufacturer) repair

- ECU/PCMs equipped with race data memory, must not have the memory erased or modified without the prior permission of the technical inspector.

- Any information sourced by the technical inspector from the ECU/PCM's race data memory which does not correspond with the technical data declared by the manufacturer in the homologation file will be viewed as reason for disqualification.

552.01 - HULL

Only monohull form is permitted. The boat shall not present in any of its lines any configuration which could contribute to aerodynamic lift.

Transverse steps, tunnels, hydrofoils or devices which tend to add to the air pressure under the hull, are prohibited, except that protruding strips substantially parallel to the fore and aft line of the keel are permitted providing that in any channels, etc. so produced the horizontal measurements, of such openings with the boat on an even keel, do not add up to a total of more than 15 cm in any transverse section. Any divergence of such strips from a line parallel to the keel must show a minimum radius of 30 cm. If stopped short of the transom, strips must be tapered off to zero over a minimum length, viewed at 90 to the line of the keel and parallel to the surface of the hull in that area, of 15 cm. A single fixed vertical fin on the underwater body is allowed for directional stability. The maximum length of the fin is 250 mm.

552.05

Any device to produce a sudden braking effect, causing excessive water spray, reducing visibility, is prohibited.

552.12 - MINIMUM DIMENSIONS

Class	Weight	Length	Width	Boat depth
JT250	160 kg	3.10 m	1.25 m	0.35 m
T 250	180 kg	3.10 m	1.25 m	0.35 m
T 400	240 kg	3.50 m	1.30 m	0.35 m
T 550	265 kg	3.75 m	1.30 m	0.40 m
T 750	270 kg	4.00 m	1.35 m	0.40 m
T 850 boat only	250 kg	4.25 m	1.40 m	0.40 m
T850 boat+driver	330 kg			

The maximum allowed ballast weight is 10 % of the specified minimum weight for each individual class. ***The ballast must be on the inside of the hull.***

1. The minimum weights mentioned here above are the weight of a complete rig weighed directly after the race including driver, personal safety equipment, residual fuel but without residual water

2. Measurements are taken while the boat is ashore.

The length must be measured as the overall length of the hull between perpendiculars at the foremost and aftmost rigid part of the hull.

Any extending parts, rubbing starches, fenders, stabilising and trim tabs and rudder are not to be included.

The width of the boat is measured at the widest part of the hull.

553 - MACHINERY

553.01

An outboard motor is a mechanical propulsion assembly which can be removed from the boat in a single unit, complete with its transmission and which does not transmit its power through the hull at any point.

The motor thus removed and placed ashore must be capable of being started, fed by its fuel tank.

The mounting supports fixed to the boat, the control levers, the tachometer with its connections, the battery with its conductors and the fuel tank and fuel lines do not form part of the motor.

The attachment angle and the height of the motor must remain fixed while the boat is under way. But it is allowed to change the attachment angle between a heat and another.

The use of powertrim is allowed for monohull boats provided with safety reinforced cockpit, per rule 509.

For all T classes, the centre of the propeller shaft (measured at the centre point of the rear end of the propeller shaft) shall not be above the bottom of the boat measured at the lowest point of the bottom. No design of the hull, by fins, keels or convex shaped bottom to obtain a higher engine position is allowed. For boats with the power trim this height will be measured with the propeller shaft set parallel with the bottom of the boat.

This dimension will be checked in the "as raced" condition.

This dimension is affected by the attachment angle. In JT.250, T 250, T.400 and T. 550, it is not allowed to change the attachment angle by other means than pulling out and resetting tilt pin or by adjusting a thrust block on the outside of the transom for which adjustment tools must be required. It is only allowed to change the attachment angle when the boat is on land. After any change of the attachment angle the propeller shaft depth must be rechecked.

553.02

To be homologated as stock motor, an outboard motor must be sold and advertised by an industrial firm as being manufactured in standard production series (that is to say with all parts interchangeable and with identical dimensions, weights and materials) for the propulsion of boats.

To be eligible for homologation, a minimum of 1000 units must have been built and assembled, certified by the manufacturer to the National Authority of the country of origin.

553.03

The motor must be able to function at reduced speed.

553.04

When the motor is in the water, the cooling must be effected by a water circulation pump.

The cooling water must circulate through the water pump and be fed only through the standard water intake, neither the position nor the shape of which may be modified.

553.05

An efficient gear changing system giving forward, neutral and astern movement is compulsory.

The control handle for the reverse gear, ready for use, must be within easy hand reach of the driver, when he is in the normal driving position. Manoeuvring of the boat astern, must be possible by selecting reverse gear.

553.06

An electric or manual starter must assure a quick and easy start without external aids. It must be used as it was supplied by the manufacturer, no adjustment or alteration being allowed.

553.10 - SOLE MODIFICATIONS ALLOWED

Only the following modifications are allowed:

1. All studs, screws, nuts, bolts and their washers are free as well as the method of locking them.
2. The original propeller may be replaced by another but in classes T.750 and T.850 4 blades maximum. Gearcases with a propeller exhaust must use propellers equipped with an exhaust tube of a diameter at least that of the machined recess into which the standard propeller boss fits at the rear of the gearcase. The length of this tube must be at least $1/2 (Q - P)$, where Q and P are the dimensions shown on the sketch of the underwater unit on the homologation file.
3. The trim tab may be altered or removed to accommodate a propeller, except in classes T.750 and T.850.
4. The cooling system must be provided by the water pump.
5. Thermostats and pressure valves of the cooling system may be removed.
6. The steering mechanism may be altered. If the original steering bar is removed or new ones are installed, any openings created must be sealed to prevent the motor from pulling in additional air.
7. The dampers (shock absorbers) may be altered or removed.

8. The rubber mounts of the motor may be altered, removed or replaced.
9. Revolution counters, water temperature gauges, water pressure gauges and similar instruments can be installed.
10. Revolution limiters may be removed.
11. The gear interlock device on the starter may be removed.
12. Spark plugs are free.
13. Original carburettor jets may be replaced for another size.
14. Springs may be added to the throttle lever of the carburettors.
15. Re-boring is allowed, but only piston assemblies supplied by the manufacturer of the motor may be used within the cc-limit of the class.
16. A part which is dimensioned in the homologation sheet may be machined for the purpose of reaching that specific measure;
17. A part may be machined to attain the weight quoted in the homologation sheet without altering other criteria given for the part in question. It is not allowed to change the flywheel but balancing machining is allowed if the dimensions and weights provided for on the homologation sheet are respected;
18. Measurements not quoted in the homologation sheet shall only be checked by visual comparison with standard parts. As the actual manufacturing tolerances are not published, small differences between the inspected part and the reference part must be accepted.
19. The fuel connector in the lower cover may be removed and the fuel hose from the fuel tank connected directly to the fuel pump. If this is done the opening left after the connector and around the fuel hose must be sealed to prevent extra air entering inside of cover.
20. Electric fuel pumps may be added provided the fuel still runs through the original fuel system and no parts are removed or blocked off.
21. No parts may be added to the motor unless specified in this rule.

22. It is allowed to extend the starter cord of a rewind starter so that the starting handle can be reached from the cockpit

554 - FUEL

See 508.01, 508.02, 508.06, 508.07, 508.08, 508.09, 508.10, 508.11.

560 - INFLATABLE BOATS (P)

561 - CLASSES

P 750 cylinder capacity of the motor from 551 cc to 751 cc incl.

Capacity	551cc to 750cc
Length	3,8m (minimum)
Width	1,7m (minimum)
Weight	75kg (minimum)

The above mentioned weights apply to the dry weight of the boat, without any accessories ,and without the engine. To reach the minimum weight ballast must be added.

This must be screwed or bolted to the boat but must not exceed 10% of the boat without ballast.

562 - HULL

562.01

The boats must conform with a model of the official catalogue of the manufacturer. A minimum of 2 boats must be built and be available for inspection before homologation is applied for.

562.02

Boats that take part in competitions must be listed in an official catalogue of the manufacturer. Manufacturers must submit homologation papers for their boats to their National Authorities and UIM, in which they must furnish valid, audited proof that 2 boats have been manufactured and have been advertised and are commercially available in the open market. In the case of imported boats, proof must be submitted to their National Authority and UIM that 5 units have been imported and meet homologation requirements. The UIM sets the closing date for homologation each year. All boats must be fitted with a serial number plate, fitted at manufacture, on either the nose cone or the transom with details of make and model at least.

562.03

Boats must be inflated with atmospheric air and must have 3 (three) independent compartments. Except for pencil boats where each individual pontoon must have 2 (two) independent compartments. The boat must be able to float even if one compartment is rendered unserviceable. Flexible foam hijackers are allowed.

562.04

Boats with inflated keel or rigid keel are allowed, boats with a rigid underwater body made of glass resin or any other type of rigid underwater body are not allowed. At no point may the width of the keel exceed 15% of the width of the boat.

562.05

The boat should be able to deflate, be collapsible, foldable or be able to be rolled up, so that no dismantled part has a length greater than 1/3 (one third) of the full length of the inflated boat excepting the floor stretchers and keel whose largest individual piece must not exceed 2/3 (two thirds) of the overhaul length of the inflated boat.

562.06

The shape of the hull is free. The keel, inflatable or rigid must not extend along the whole floor length of the boat. No rigid element is to be attached or fixed to the underside of the keel. No material other than air may be inserted in or attached to or placed between the floor boards and the floor, other than the keel, except for river racing and then only foam may be used. No aerodynamic appendage is allowed.

562.07

Modifications above the waterline are allowed. These modifications will refer to foot straps, handles, loop patches etc. only and not modifications that interfere with original dimensions of the boat. A waterline is defined as the line taken when a boat is at rest in the water with no person in the boat, but with full race trim with the motor fitted. The waterline will be deemed to be below the bottom of the transom in the case of multi-hull type boats.

562.08

A splash plate may be fitted to the back of the transom as long as it complies with rule 562.07 and the following dimensions: If this plate runs the full length of the transom i.e. from pontoon to pontoon, then the width of this plate is restricted to 100mm. If the width of this plate exceeds 100mm then its length is restricted to 150mm across the back of the transom but may protrude as far back towards the motor as required.

562.09

Motors larger than the inflatable boat manufacturer's recommended maximum horsepower rating at the time of hull manufacture will not be allowed. The manufacturer must state the maximum horsepower rating when applying for Homologation.

562.10

All boats must have 2 (two) transparent windows, 250mm wide by 700mm long, into which the event sponsors decal must be placed. These windows must be securely fixed to the top of each side of the nose of the boat and for pencil boats as close to the front of the pontoon as possible, but must be clearly visible. Additional transparent windows (4) must be fitted for the boat number.

562.11

All boats must be fitted with two designated righting ropes/webbing. These ropes/webbing may not share common use as the designated bowline. The ropes must be at least 10mm thick and the webbing at least 25mm wide..

562.12

All boats must be fitted with a designated bowline, which must be a standard nylon 3 strand rope/ webbing, minimum 10mm thick in the case of a rope and 25mm wide in the case of webbing. Length must be 4m with a spliced or stitched eye at the end of the rope/webbing. All boats must have a designated fixed towing point situated in the nose cone area to facilitate safe towing of the boat. The bowline must be fixed to the nose cone in a pouch glued to the back of the nose cone. The towing point must be able to withstand a pulling power of at least 3 times the fully laden weight of the boat or 300kg.

562.13

It is the competitor's responsibility to ensure that the team boat is within the legal requirements with regards to the homologation specifications. Ignorance of the above will not be accepted as a defence and he/she shall be disqualified in terms of the rules.

563 - MACHINERY**563.01**

An outboard motor is a mechanical assembly that can be removed from the boat in a single unit complete with its transmission and which does not transmit power through the hull at any point. The motor thus removed and placed ashore must be capable of being started, fed by its own fuel tank. The mounting supports fixed to the boat, the control levers, the tachometer with its connection, the battery with its conductors and the fuel tank and fuel lines do not form part of the motor unit. The attachment angle and the height of the motor must remain fixed whilst the boat is underway. Power trim and tilt units are prohibited.

563.02

To be homologated as a sports motor, an outboard motor must be sold and advertised by an industrial firm as being manufactured in standard production series (that is to say with all identical dimensions, weights and material) for the propulsion of tourist boats. To be eligible for homologation, a minimum of 1000 units must have been built and assembled, certified by the manufacturer of the National authority of the country of origin. No performance enhancement kits are allowed.

563.03

The motor must be to function at reduced speed.

563.04

When the motor is in the water the cooling must be effected by the motors own circulating pump. External pick-ups or water pick-ups attached or affixed to the boat or motor are prohibited.

563.05

An efficient gear changing system giving forward, neutral and astern movement is compulsory. The control handle for the gear changing system, ready for use must be within reach of the driver. Astern manoeuvring of the boat must be possible by selection of reverse gear only.

563.06

The manual starter must ensure a quick and easy start without external aids. It must be used as it was supplied by the manufacturer, no adjustments or alterations being allowed. The motor must be fitted with operating cord actuated safety cut-out switch. The length of the operating cord must not exceed 1,5metres.

The "kill switch" and lanyard must be attached to the driver and plugged in during a race at all times. Failing to abide by this rule will entail disqualification from the event.

563.07

A boat, motor or any part thereof that is irreparably damaged due to no fault of the competitor may be replaced during an event at the discretion of the OOD. All replaced items must be made available for inspection if so requested. All relevant racing numbers must be correct on the replaced equipment. The replacing motor must be sealed in accordance with the rules and the old motor must be placed in the impound area for inspection. All costs pertaining to the stripping of additional will be carried by the competitor in question.

563.08

All leading edges of the gear case may not be tampered with. Only normal wear and tear is acceptable. The tolerance for this wear and tear is limited to 5mm. A stainless steel cover, with the same characteristics as an original gearbox can be used to protect the leading edges.

563.09 - SOLE MODIFICATIONS ALLOWED

- 1) All studs screws, nuts, bolts and washers are free as well as the method of locking them.
- 2) The original propeller may be replaced by any other one with a through the hub exhaust as long as the replacement is listed in an official catalogue of the propeller manufacturer and is freely available. The number of blades is restricted to a maximum of three (3). No holes or ventilation slots of any nature whatsoever are allowed in the hub or the blades. Modifications done to the blades is allowed.
Minimum hub length: 108mm.
Minimum hub diameter:76.5mm (gearbox interface)
Minimum distance propeller into gearbox: 1mm
Transgression of this rule will lead to disqualification.
- 3) The trim tab may be removed or altered to accommodate the propeller.
- 4) The cooling system must provided by motors integral water pump.
- 5) Thermostats and pressure valves of the cooling system may be removed.
- 6) The steering bar and brackets may be reinforced and additional steering bars may be mounted. If the original steering bar is removed or new ones installed, any opening created must be sealed to prevent the motor from drawing in additional air. Steering bars must be able to tilt independently from the motor. Strengthening of the transom bracket and lower leg are permitted.
- 7) The dampers (shock absorbers) may be altered or removed.
- 8) Rubber mounts of the motor may be altered, removed or replaced.
- 9) Over rev limiters and lighting coils may be removed.
- 10) Revolution counters, water temperature gauges, water pressure gauges and similar instruments can be fitted.
- 11) The gear interlock device on the starter may be removed.

- 12) Spark plugs, spark plug caps and HT leads are free.
- 13) All auto lube systems may be removed, together with all parts related thereto.
- 14) Carburettor jets (air and fuel) may be interchanged, provided that the parts fitted are genuine manufacturer parts and are quoted in their official catalogue for the specific model. Emulsion tubes are to be standard "off the shelf" items and have the same pre-requisites the jets. No modifications are allowed to these parts.
- 15) Springs may be added to the throttle lever of the carburettor
- 16) Baffle plates in the carburettor fuel bowls to prevent fuel surge are permitted.
- 17) Re-boring is allowed up to the limits provided for by the manufacturer and only piston supplied by the manufacturer of the motor may be used with in the cc limit of the class.
- 18) A part which is dimensioned in the homologation sheet may be machined for the purpose of reaching that specific measure. The shape of the part may not change.
- 19) A part may be machined to attain the weight quoted in the homologation sheet without altering other measurements given for the part in question. It is not allowed to change the flywheel but balancing machining is allowed if the dimensions and weights provided for on the homologation sheets are respected.
- 20) Measurements not quoted in the homologation sheet may not be altered in any form (e.g. polished sanded etc.). If detail cannot be verified with the aid of pictures in the homologation sheet, the part in question can be compared to a corresponding stock part. In such a comparison three identical parts must be used to get an average for the measurement. As the actual manufacturing tolerances are not published, small differences between the inspected part and the reference parts must be accepted.
- 21) No parts may be added to the motor unless specified in this rule.

- 22) The crankshaft may be welded or pinned as long as the dimensions of the crankshaft after welding do not exceed the original manufacturers dimensions and width of the crankshaft. Any pins may not exceed 12mm in length.
- 23) Telltale cooling pipe may be replaced with another pipe of other characteristics.
- 24) A splash plate may be fixed to the trunk of the motor provided it is not rigid and that it is fitted above the cavitations plate.
- 25) The motor cowling may be secured by means other than. or in addition to the standard means. Fastening of the cover must be adequate to satisfy the scrutineers.

564 - FUEL

564.01

Fuel must be a commercially available grade of automotive fuel, to a maximum of 97- octane. Which is freely available from any normal service station outlet i.e. from the pumps on any forecourt.

564.02

Special racing fuels, methanol, nitro-methane, avgas, hydrazine and the likes thereof are forbidden. The use of additives aimed at increasing the power of the engine is prohibited to either the fuel or air intake. In addition the use of nitrous oxide injection units are totally prohibited.

564.03

Only the original fuel tank as supplied with the engine. Collapsible fuel cells or approved manufacturers marine fuel tanks are permissible.

564.04

The driver may not withhold the type of fuel/oil used and mixing ratio of fuel/oil if so requested by racing officials.

564.05

Oil will be supplied by the competitor with unbroken seal, and then held by the organizers for the duration of the event. A warm up lap before the start of the race is mandatory.

564.06

At regional, national and international events, the organizers reserve the right to use a nominated fuel supplier. Failure by the competitors to use the nominated supplier will result in disqualification from the event.

564.08 - PROTECTING HELMET

See UIM rule 205.07.

564.09 - LIFE JACKET

See UIM rule 205.06.

564.10 - EYE PROTECTION

In both Surf and Circuit racing, eye protection is compulsory for both the driver and the co-driver. This protection may take the form of goggles or a helmet visor.

564.11 RACE IN PROGRESS RULES - CIRCUIT

1) No driver will be allowed to compete in a circuit National event unless his/her license has been endorsed by the his/her club or National Authority.

- 2) No co-driver will be allowed to compete in a circuit National unless hi/her license has been endorsed by his/her club or National Authority.
- 3) The first heats grid position for every circuit event will be determined by draw prior to the event. For consecutive heats the grid position will be for the finish position in the previous heat.
- 4) If a competitor misses a buoy he will be disqualified from that heat.
- 5) Deliberate bumping of another competitor will result in disqualification from the race.
- 6) If one boat lands on another, the offending parties will be disqualified from the race.
- 7) If a competitor rides over a buoy he will be disqualified for that heat.
- 8) A competitor following too closely to another competitor will receive a yellow card for a first offence. A second offence will result in disqualification from that heat.
- 9) The standard course for circuit racing is shown diagrammatically in annexure B. The start for circuit racing will be a dock or jetty start.
- 10) If any boat collides mid-ships with another (T- bone) this will result in immediate disqualification of the offending boat from that heat.
- 11) All drivers must maintain their lanes up-to and around the first turn buoy. Competitors may not change lanes in front or behind another competitor until they have passed and rounded the first buoy, or they will be disqualified from the heat.

- 12) Starts will utilize two flags, both driver and crewman may be in the boat. Both flags will be raised and on dropping the first flag the motor may be started in neutral gear. On dropping the second flag forward gear must be selected and the race may commence All must do the long lap as a first lap (i.e. first lap to include equalizer lap) This does not count as one of the compulsory laps. If a boat jump starts the start for the first time it will be moved to the end of the grid. If the same boat jumps the start again it will be disqualified. If another boat jumps the start after a previous jumped start, that boat will move to the end of the grid next to the first offender.
- 13) Each competitor must complete 2 (two) laps of the equalizer circuit during each heat. Failure to do 2 (two) laps will result in the competitor being disqualified for the heat. These must be completed after the 1st lap and before the start of the final lap.
- 14) All heats will consist of 9 (nine) laps
- 15) After finishing a heat all boats must proceed around the next buoy beyond the finish buoy/line and wait for a red flag before returning to shore. If any competitor fails to comply with this rule, he will be disqualified from that heat. Boats that have not completed 66% of the race when the winner crosses the finish line, will not score points for that heat.
- 16) There will be a minimum of 3 (three) and a maximum of 12 (twelve) boats allowed per heat in the case of circuit racing.
- 17) In the event of there being more than 12 (twelve) boats, eliminations will be run as follows: The boats must be divided into equal sections and each section will run two qualifying heats with points to count as for normal championships. The top qualifiers in each section will go forward into a final heat that must consist of 12 (twelve) boats. Points for the final heat will count double points. Grid positions as per rule 564.11.03

- 18) The total points for the 2 (two) qualifying plus the final heat will be added together to determine all the competitors final placing from 1-12. Positions from 13-20 will be awarded to competitors with the highest points from the qualifying heats. The rest of the competitors who competed in the heats will all receive 1 (one) point.
- 19) If any competitor lands in the water whilst under starters order or during a race, the race will be stopped immediately, with or without a red flag being raised. In the case of circuit racing, all competitors are compelled to stop racing clear the course and proceed to the start with extreme caution. Crews may not refuel or make any changes to the equipment and must be ready for an immediate restart of the heat. Any competitor refuelling or making changes will be disqualified from that heat. Only 2 (two) restarts per heat are permitted.
- 20) The offending team referred to in the previous rule 564.11.20 will not be permitted to take part in any restart of that heat.
- 21) If a boat should burst during a heat for any reason, that boat will immediately cease racing and clear the course. This also applies to a competitor who loses a helmet during a race.
- 22) If all boats have completed more than 2/3 (two thirds) of the race there will be no restart of that heat and the results will be taken in the order the boats last passed the finishing buoy. The offending team will not be awarded points for that heat.
- 23) Rules 564.11.20, 564.11.21, 564.11.22 do not apply to river and Long haul racing but if a competitor falls from his boat , all following competitors must exercise extreme caution and render assistance to a fellow competitor if they are in immediate danger.
- 24) Flags:
- | | |
|--------------------|-----------------------------|
| Chequered flag | End of race/winner |
| White flag | Last lap / One lap to go |
| Red flag | Race stopped / clear water. |
| Yellow flag | Caution / Danger on circuit |
| Yellow flag waving | Immediate caution. |

Black flag with number	Stop racing/ leave water boat
Green flag	Start race

- 25) All competitors must acknowledge all flag signals to the official giving the signal. Failure to comply with this rule will render the competitor liable for penalties.
- 26) The race will be live when the green flag drops. The hat is live when the last boat crosses the start/finish line.
- 27) All boats must carry the following safety equipment at all times during the event.
All safety equipment must be marked with the competitors race number.
- Paddle x 2
Designated righting rope/webbing x 2
Designated bow line
Kill switches x 2

564.12 - RACE IN PROGRESS RULES - SURF

- 1) No team will be allowed to compete in a National surf event unless the team's licenses have been endorsed by their club or National authority. Both driver and co-driver must have a National license to compete in national events. No day licenses will be issued for National events.
- 2) For the first heat of the first surf event of the season, the grid positions will be according to the competitors Surf Championships in the previous season. The balance will line up in race number order. The positions for the second heat will be as the competitor finished in their first heat. The final heats grid is determined by the highest number of points scored in the first two heats. In the event of a tie, the fastest heat winning time will break the deadlock.

- 3) For the current season, the second events first heats grid will be as per competitors position in the individual championship, thereafter as for rule 564.12.02 . (pertaning to the second heat).
- 4) If a competitor misses a buoy and crosses the racing line he/she will be disqualified for the heat.
- 5) If a competitor touches or bumps a buoy with his/her boat he/she will be disqualified for that heat and will not be allowed to take part in the re-run or re-start of that heat.

A competitor that destroys a buoy will reimburse the hosting club with replacement of that buoy.
- 6) Deliberate bumping of another competitor will result in disqualification from the race.
- 7) If one boat lands on another, the offending party will be disqualified from the race.
- 8) A competitor following too closely to another competitor will receive a yellow card for the first offence and disqualification from the for a second offence.
- 9) The standard course for surf racing is shown diagrammatically in Annexure A and the start will be a beach start. The format of this start will be as per rule 564.12.19.
- 10) If any boat collides mid ships with another (T .Bone) this will result in immediate disqualification of the offending boat from that heat.
- 11) There must be a minimum of 10 (ten) metres between the shore buoy and the shore.
- 12) All heats will be 9 (nine) laps.
- 13) After finishing a heat all boats must proceed around the next buoy beyond the finish buoy and wait for a red flag before returning to shore. Boats that have not completed 66% of the race when the winner crosses the fish buoy/ finish line will not score points for that heat. Boats running out of fuel during the race will be disqualified.

- 14) There will be a minimum of 3 (three) boats and a maximum of 12 (twelve) boats allowed per heat in the case of surf racing.
- 15) In the event of there being more than 12 (twelve) boats, elimination heats will be run as follows: The boats must be divided into equal groups and each group will run two qualifying heats with points to count as for national championships. The top 6 qualifiers in each group will go forward into a final heat that must consist of 12 (twelve) boats. The final heat will be 9 (nine) laps. Only in the event of an elimination will the final points count double points. Grid positions will be as per rule 564.12.03.
- 16) The total points for the 2 (two) qualifying heats plus the final heat will be added together to determine the competitors final placing for positions 1-12. Positions 13 onward will be awarded to the competitors with the highest points from the qualifying heats. The of the competitors who competed will receive 1 (one) point.
- 17a) The start will as follows: Both driver and co-driver will be out of the boat, the kill switch may be plugged in and on the drop of a single green flag the race will start. Both hands of the driver must be on the anti-hogging rope. Both feet of the driver and co-driver must remain on the ground at all before the green flag drops The driver must have both feet on the floor board of his/her boat before h/she is allowed to start the motor. A co-driver may not start the motor at the start of the race. Failure to abide by this rule will result in receiving a yellow card and being moved to the back of the grid. Due to surf conditions, the start may be changed after consultation between the OOD and the drivers panel.
- 17b) Any competitor not on the start line when the green flag is raised may not start that heat.
Any boat that fails to start when the green flag is dropped may only then enter the course when it is safe to do so. This is only allowed if the first lap was not completed and the start is from the beach. One back up crew per team is allowed to assist in the start. He must be positioned opposite the driver in the start. Any driver that was not on the starting line the first time the heat was run will be allowed to start if there is a re- run or re-start of that heat only if he/she is on the starting line when the green flag is raised for the re-start.

- 18) Any team jumping the start by starting his/her engine before the green flag is dropped or does not have both feet on the ground will receive a yellow card and be moved to the end of the grid. In the event of a second jump start (false start) the offending team will be disqualified from that heat.
- 19) Restart of a heat/final will be done in a pace boat leading the boats in a staggered formation. The race will be started from either the pace boat in the back straight during Adverse conditions or from the beach during good conditions. In both cases of starting, the boats must muster at the area of buoy 1 (the first turn buoy) and a green flag will be used. The boats must keep their positions as per the previous lap and follow each other closely. Boats are not allowed to overtake or change positions up to the dropping of the green flag. A dedicated official will monitor grid positions prior to drop of the green flag. Any competitor changing positions during the run up to the starter or when under starters orders with the re-start of the heat will be disqualified. Laps for the re-start will be reduced from 9 to 6 to 4 respectively.
- 20) If any competitor lands in the water or a boat should get stuck on the beach during a race, the race will be stopped immediately, with or without the red flag being raised. In the case of surf racing , all competitors are compelled to stop, clear the course and proceed to the start line with extreme caution. Crews may not re-fuel or make any changes to their equipment and must be ready for an immediate re-start of the heat . Any competitor refuelling or making changes will be disqualified from that heat. Only 2 (two) restarts per heat are permitted.
- 21) If a boat should burst or deflate rapidly during a heat for any reason, that boat will immediately cease racing and clear the course. This also applies to a competitor who loses a helmet during a race.
- 22) The offending team referred to in rule 564.12.20 will not be permitted to take part in restart or re-run of that heat unless, in the case of a boat getting stuck, they are allowed by the OOD.

- 23) If more than 2/3 (two thirds) of the race have been completed by all boats, there will be no restart of that heat and the results will be taken in the order that the boats last passed the finish buoy. The offending team will not be awarded any points for that heat.
- 24) Rules 564.12.20, 564.12.21, and 564.12.22 do not apply to River and Long haul racing, but if a competitor falls out of his/her boat, all competitors following must exercise extreme caution and render assistance to fellow competitors if they are in immediate danger.
- 25) Flags:
- | | |
|-----------------------------|----------------------------|
| Chequered flag | End of race/Winner |
| White flag | Last lap/one lap to go |
| Red flag | Race stopped/ Clear water |
| Yellow flag | Caution/ Danger on circuit |
| Yellow flag waving | Immediate caution |
| Black flag with boat number | Stop racing/ Leave water |
| Green flag | Start flag |
- 26) All competitors must acknowledge all flag signals to the official giving the signal. Failure to comply with this rule, will render the competitor liable for disqualification.
- 27) The race will be live when the green flag drops. The heat is live when the last boat has crossed the start/ finish line for the first time. If the last boat has not passed the start/ finish then the restart will be for the full amount of laps.
- 28) All boats must carry the following safety equipment at all times during the event: All safety equipment must be marked with the competitors race number:

Paddles X 2
 Designated righting rope/ webbing X 2
 Designated bow line
 Kill switches X 2

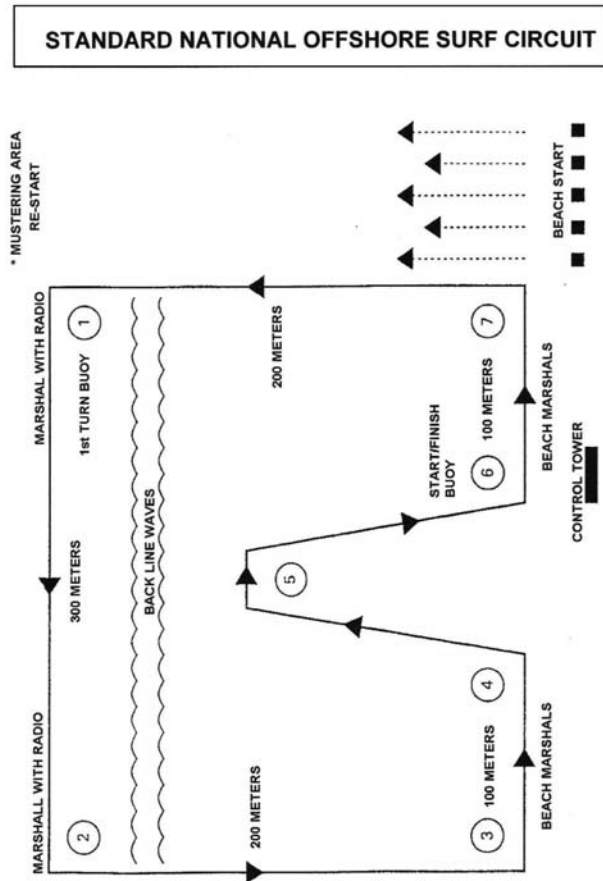

ANNEXURE B
PROPOSED STANDARD CIRCUIT COURSE FOR NATIONALS

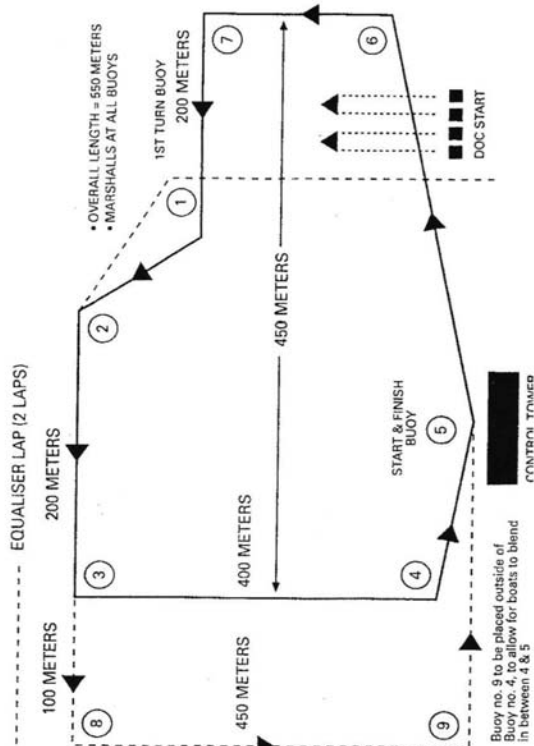

564.13 - GENERAL

- 1) One boat in a class will constitute a class. No handicap racing will be allowed as this is detrimental to the sport and not in line with International racing. Competitors must enter at least 14 days prior to the event. Any entry after that period will be treated as a late entry.
- 2) No abuse of officials will be tolerated. Any team or members of their family, abusing any official will be disqualified and the race jury reserves the right to take appropriate action against the team.
- 3) A competitor must direct all queries to the OOD when racing is not in progress. He/she may not address queries to any other official. No competitor is permitted into the control tower during and immediately after an event, until such time as the results are official and have been posted.
- 4) Only a driver may direct a query or protest to the OOD. For a race infringement this must be done immediately after the heat and must be directed to the OOD or assistant OOD. All such protests must be in writing accompanied by the prescribed protest fee as determined by the National Authority.
- 5) Intentionally causing damage to another boat, or intentionally causing bodily harm to a member of another boat will not be tolerated. Any one failing to comply with this rule will be disqualified from the event.
- 6) Drinking alcoholic beverages or the use of intoxicating drugs by any competitor or race official prior to completion of racing is strictly prohibited. Violation of this rule will result in immediate disqualification from the event, suspension for the remainder of the season and a monetary fine to be determined by the National Authority.
- 7) A driver may not be under the age of 18 (eighteen) years and a co driver under the age of 16 (sixteen) years to compete in the national championships. Proof of age is required.

- 8) An overlap can only be established when two boats are on the course and the overtaking boat has pulled up level with the boat he is overtaking. The overtaking boat may not create the overlap outside of the set course. While overtaking ,the overtaking boat must leave water for the overtaken boat.
- 9) After a finding of gross infringement of the rules or a gross breach of good manners or sportsmanship, the OOD or jury may exclude a competitor or boat when appropriate from a race or meeting.
- 10) The race organizers of a National championship have the right to inspect and measure the first three boats plus another from each class to ensure legality.
- 11) Failure of a competitor to comply with any of the above rules or those of the UIM may result in the suspension of his license at the discretion of the governing bodies of the sport.
- 12) Any driver who is warned by the OOD for dangerous driving will receive a yellow card and have his license endorsed to reflect this warning. On the driver receiving a second warning during a season he /she will be disqualified from the event as well as competing in the next National event.
- 13) All drivers and co-drivers must sign a declaration that they have sufficient medical and life cover, which must be submitted when applying for a license.
- 14) All protests, appeals and penalty will be dealt in accordance with section 400 in the UIM circuit rule book.

564.14 - P750 SERIES RACING

The following rules apply to UIM class P750.

For 2007 this will be run under “experimental class” rule 101.01 for the racing format to be used. All current UIM P750 circuit rules regarding safety/discipline will apply.

Proposed racing format will be agreed between any National Authority taking part in these races in 2007 with the authorisation of the UIM and approved by the UIM Cominsport.

After one year, the agreed rules will be presented to the UIM at the 2007 General Assembly for 2008. Control of this class will remain under the UIM Sports Commission even if run by a promoter.

565 - RIGID INFLATABLE BOATS (PR) (PF)

566 - CLASSES

PR 550 cylinder capacity of the motor to 550 cc incl.

PR 700 cylinder capacity of the motor from 725 cc incl.

PR 750 cylinder capacity of the motor from 551 cc to 770 cc incl.

PR 850 cylinder capacity of the motor from 771 cc to 870 cc incl.

PR 1000 cylinder capacity of the motor from 871 cc to 1060 cc incl.

PR 1500 cylinder capacity of the motor from 1061 cc to 1550 cc incl.

PR 2000 cylinder capacity of the motor from 1551 cc to 2050 cc incl.

PR 3000 cylinder capacity of the motor from 2051 c to 3150 cc incl.

A free category (e.g. catamaran) is established in the following classes:

PF 550 cylinder capacity of the motor to 550 cc inclusive

PF 750 cylinder capacity of the motor from 551 cc to 750 cc incl.

PF 850 cylinder capacity of the motor from 751 cc to 870 cc incl.

566.01 - LOW EMISSION ENGINES

Additional provisional classes for 2007 and 2008 for low emission engines complying with 2006 EPA rules (as per homologation sheet) :

PR 30 HP Horse-power of the engine not more than 30

PR 60 HP Horse-power of the engine not more than 60

PR 115 HP Horse-power of the engine not more than 115

PR 200 HP Horse-power of the engine not more than 200

PR ∞ Horse-power of the engine – unlimited

The races in these classes are run along with conventional classes. The classification can only be established if there is a minimum of 5 entries per event per provisional class. The organizer must provide the equipment necessary to confirm the power rating of the engine in accordance with the UIM / Engine manufacturer recommendations, otherwise there will be no classification in provisional classes.

567 - HULL (PR CLASSES ONLY)

567.01

The bottom of the hull may be convex, but not be concave.

Hull consists of rigid centre section and pneumatic tubes.

The rigid centre section, keel, transom etc. must be made of fibreglass or plastic.

Pneumatic tubes must be inflated with atmospheric air and made with fabrics with plastometers and elastometers in two or more independent compartments.

567.02

To reach the minimum weight, fixed ballast is allowed, and must be permanent rigid and fixed to the inside of the hull.

It should not exceed 10 percent of the weight of the hull without ballast.

567.03

Only monohull form is permitted. The boat shall not present in any of its lines any configuration which could contribute to aerodynamic lift.

Transverse steps, tunnels, hydrofoils or devices which add air pressure under the hull, are prohibited, except that protruding strips or redans parallel to the fore and aft line of the keel are permitted providing that in any channels, etc. so produced the horizontal measurements, of such openings with the boat on an even keel, do not add up be a total of more than 10% of the width of the hull in any transverse section for PR 850 and below and 20 % for PR 1000 and up. This includes the tunnels of the joint between the tubes and the rigid hull for PR 850 and below.

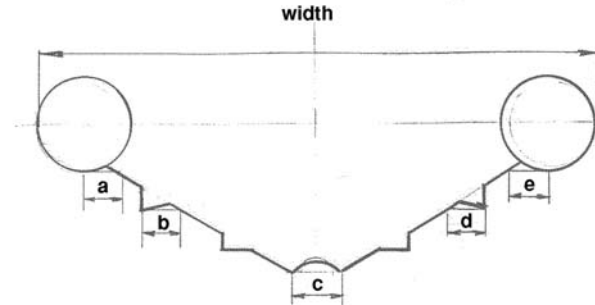

For PR 550, 700, 750, 850 : $a+b+c+d+e < 10\%$ of the width
For PR 1000, 1500, 2000, 3000 : $b+c+d < 20\%$ of the width

567.04

Steering by a steering wheel is mandatory, the control handle for reverse gear must be within hand reach of the driver.

Kind, number and position of seats are free.

Restraint system (driver harness) is prohibited.

The use of any device or part of the boat construction, which is blocking the driver from freely getting out of his sitting position, without removing the above-mentioned device or part, is prohibited.

567.05

Any device to produce a sudden braking effect, causing excessive water spray, reducing visibility, is prohibited.

567.12 - MINIMUM DIMENSIONS

Class	Weight	Length	WidthH	Amidship Min. Tube Diameter
PR,PF550	200 kg	3.50 m	1.50 m	0.25 m
PR700	280 kg	3.70 m	1.60 m	0.25 m
PR,PF750	280 kg	4.00 m	1.70 m	0.30 m
PR,PF850	300 kg	4.10 m	1.80 m	0.35 m
PR1000	470 kg	4.20 m	1.80 m	0.35 m
PR1500	520 kg	5.00 m	1.80 m	0.35 m
PR2000	600 kg	5.30 m	1.80 m	0.40 m
PR3000	680 kg	5.60 m	2.00 m	0.40 m

1. The minimum weights mentioned here above are the weight of a complete rig weighed directly after the race without driver, residual water but including the residual fuel.
2. Measurements are taken while the boat is ashore.

The length must be measured as the overall length of the between perpendiculars at the foremost part of the boat including the pneumatic tubes to the utmost part of the boat.

Any extending parts, rubbing starches, fenders, stabilising and trim tabs and rudder are not to be included.

The width of the boat is measured at the widest part of the boat.

3. The tube diameter will be measured amidships of the boat. The diameter in the bow should be at least 0.25 m in classes PR700 up. PR550 class can go down to 0.20 m.

568 - MACHINERY

568.01

Only one propulsion motor is allowed and all of the propulsive effort shall be exerted through the water.

An outboard is a mechanical propulsion assembly which can be removed from the boat in a single unit, complete with its transmission and which does not transmit its power through the hull at any point.

The motor thus removed and placed ashore must be capable of being started and run, fed by its fuel tank.

The mounting supports fixed to the boat, the control levers, the tachometer with its connections, the battery with its conductors and the fuel tank and fuel lines do not form part of the motor unit.

The attachment angle and the height of the motor must remain fixed while the boat is under way.

For PR,PF 550 the centre of the propeller shaft (measured at the centre point of the rear end of the propeller shaft) shall not be above the bottom of the boat measured at the lowest point of the transom. This dimension will be checked in the "as raced" condition.

568.02

The outboard motor must be able to function at reduced speed.

568.03

When the motor is in the water, the cooling water must be fed by the water circulation pump.

568.04

A gear changing system giving forward, neutral and astern movement is compulsory.

The control handle for reverse gear must be within hand reach of driver.

The casing of the underwater unit (gear case) is free. All internal parts referred to on the homologation file must be maintained. Should the homologation provide for it, the exhaust will be a propeller exhaust.

568.05

An electric or manual starter to assure a quick and easy start without complications must be fitted.

It must be used as it was supplied by the manufacturer.

568.10 - SOLE MODIFICATIONS ALLOWED

Only the following modifications are allowed:

1. All nuts, screws, washers and bolts may be replaced.
2. The original propeller may be replaced by another. Gearcases with a propeller exhaust must use propellers equipped with an exhaust tube of a diameter at least that of the machined recess into which the standard propeller boss fits at the rear of the gearcase. The length of this tube must be at least $1/2 (Q - P)$, where Q and P are the dimensions shown on the sketch of the underwater unit on the homologation file.
3. The trim tab may be altered or removed to accommodate a propeller.
4. The cooling system must be provided by the water pump.
5. Thermostats and pressure valves of the cooling system may be removed.

6. The steering mechanism may be altered. If the original steering bar is removed or new ones are installed, any openings created must be sealed to prevent the motor from pulling in additional air.
7. The dampers (shock absorbers) may be altered or removed.
8. The rubber mounts of the motor may be altered, removed or replaced.
9. Revolution counters, water temperature gauges, water pressure gauges and similar instruments, can be installed.
10. Revolution limiters may be removed.
11. The gear interlock device on the starter may be removed.
12. Spark plugs are free.
13. Original carburettor jets may be replaced for another size.
14. Springs may be added to the throttle lever of the carburettors.
15. Re-boring is allowed, but only pistons supplied by the manufacturer of the motor may be used within the cc-limit of the class.
16. A part which is dimensioned in the homologation sheet may be machined for the purpose of reaching that specific measure;
17. A part may be machined to attain the weight quoted in the homologation sheet without altering other criteria given for the part in question. It is not allowed to change the flywheel but balancing machining is allowed if the dimensions and weights provided for on the homologation sheet are respected;
18. Measurements not quoted in the homologation sheet shall only be checked by visual comparison with standard parts. As the actual manufacturing tolerances are not published, small differences between the inspected part and the reference part must be accepted.
19. No parts may be added to the motor unless specified in this rule.

20. The fuel connector in the lower cover may be removed and the fuel hose from the fuel tank connected directly to the fuel pump. If this is done the opening left after the connector and around the fuel hose must be sealed to prevent extra air entering inside the cover.
21. Electric fuel pumps may be added provided the fuel still runs through the original fuel system and no parts are removed or blocked off.
22. It is allowed to extend the starter cord of a rewind starter so that the starting handle can be reached from the cockpit/drivers position.

569 - FUEL

See 508.01, 508.02, 508.06, 508.07, 508.08, 508.09, 508.10, 508.11.

570 - BOATS WITH DIESEL MOTORS (D)

571 - CLASSES

571.01

As far as speed competitions are concerned, U.I.M. makes no distinction between boats with gasoline or Diesel motors.

571.02

This class is not subject to any restriction as to the form of the hull, the cylinder capacity or weight, except in the "offshore" class boat q.v.

571.03

For world speed, distance and duration records, the U.I.M. recognises a single class of boats with one or more Diesel motors.

572 - HULL

572.01

The hull design is free.

573 - MACHINERY

573.01

Reverse gear is not compulsory.

573.02

Any system of supercharging is allowed without penalisation.

573.03

In normal running order: a diesel motor is defined as one in which the ignition of the fuel air mixture is caused only by the heat of the compression.

573.04

The fuel used is injected into the combustion or pre combustion chamber, and not introduced into the inlet manifold together with the air for combustion.

573.05

To start the motor, either before a race or after its stopping at a refuelling station, conditions contained in Articles 573.03 to 573.04 are not obligatory.

573.06

Starting the motor must be done only under the direct supervision of the Technical Officer in order to have the conditions stipulated in rules 573.04 enforced at the start and during the whole event.

574 - FUEL

See 508.04.

580 - TURBO JETS AND ROCKET PROPELLED BOATS (TR)**581 - CLASSES****581.01**

The two series are classified as follows:

250 kg 350 kg 500 kg 900 kg 1200 kg; unlimited (infinity) kg; and prototypes.

581.02

These boats are not entitled to race, though they can attempt world speed records.

581.03

Turbo-jet and rocket propelled boats are accepted as international series.

582 - HULL**582.01**

The hull design is free.

582.02

Weighing of the boats in running order must be made possible when a record attempt is made, by means of a balance duly certified by the appropriate Weights and Measures Authority.

582.03

The boats are to be weighed without driver, residual water, but with residual fuel.

582.04

Any device to produce a sudden braking effect, causing excessive water spray, reducing visibility, is prohibited.

582.05

The measurer must certify that the boat as weighed is in running order, only the addition of the driver, water, oil or fuel needed to operate is allowed.

582.06

A UIM registered reinforced cockpit is required. Following rules are recommended: 509.02 (HANS device and seat); 509.16 (canopies); 509.20 (air supply).

583 - MACHINERY**583.01**

A turbo-jet is a rotating motor which converts directly into mechanical work, the energy produced from an expanding fluid.

583.02

A rocket is an motor which burns two fuels other than air. These two fuels are combined so as to obtain a mass of gas which is ejected at high speed.

583.03

Propulsion is according to the physical law which states that action and reaction are equal and opposite.

584 - FUEL**584.01**

The fuel is free.

590 - BOATS WITH AERIAL PROPELLER (A)**591 - CLASSES****591.01**

The boats in this series are divided into classes as follows:

250 kg - 350 kg - 500 kg - 900 kg - 1200 kg and ? kg.

592 - HULL**592.01**

The hull design is free

592.02

Weighing the boats in running order must be possible at any meeting or record course, by means of a balance duly certified by the appropriate Weights and Measures Authority.

592.03

The boats are to be weighed without driver, residual water, but with residual fuel.

592.04

Any device to produce a sudden braking effect, causing excessive water spray, reducing visibility, is prohibited.

592.05

The measurer must certify that the boat as weighed is in running order.

593 - MACHINERY**593.01**

The machinery is free.

594 - FUEL

The fuel is free.

595 - ELECTRIC POWERED BOATS (E)**596 - CLASSES****596.01**

Battery powered 48 volt runabout

Battery powered 72 volt runabout

Battery powered 144 volt runabout

Battery powered 48 volt hydroplane

Battery powered 72 volt hydroplane

Battery powered 144 volt hydroplane

Solar powered

Hybrid battery/solar powered

596.02

Electrically propelled boats are accepted as an international series.

597 - HULL**597.01**

Electric powered Runabout.

Hulls are defined as a displacement type, having no steps, no breaks in the longitudinal or transverse continuity of the immersed surface other than the keel, rubbing strips or lapstrakes of no more than 18.75 mm (0.75 in) and parallel to the centreline of the boat.

Hulls are not permitted to depend on external air pressure or design which creates a tunnel effect to aid planing.

Hulls are not required to conform to any maximum or minimum dimension restrictions.

Hulls shall not have a sponson/pod protruding from the side of the boat which interrupts the line of the side non-trip or bottom of the boat.

597.02

Electric hydroplane:

Hulls are unrestricted. Any boat having a multiple planing area or which cannot qualify as a runabout is considered a hydroplane.

597.03

Hybrid solar/battery powered marathon boats:

The hull is free.

598 - MACHINERY**598.01**

The whole of the propelling power shall be electric.

Excluding noted class restrictions for motors, drive train design is unrestricted.

598.02 - ELECTRIC RUNABOUT AND HYDROPLANE

The whole of the electrical energy shall be battery stored and carried on board and when the boat is being timed or raced over the measured distance, no additional electric power shall be generated.

Power source *for circuit racing* shall be multiples of commercially available lead/acid batteries, nominally rated at 12 volts.

Motors are restricted to brush type direct current only.

598.03 - BATTERY POWERED MARATHON BOATS

The whole of the electric energy shall be battery stored and carried on board and when the boat is being timed or raced over the measured distance, no additional power shall be generated.

Power source shall be multiples of commercially available lead/acid batteries, nominally rated at 12 volts.

Total battery weight shall not exceed 56.699 kg (125 pounds).

598.04 - SOLAR POWERED

The whole of the energy required shall be from ambient solar power excluding wind. Solar collectors designed as rigid or flexible sails are not allowed.

598.05 - HYBRID SOLAR/BATTERY POWERED

The whole of the propulsion energy shall be battery stored and carried on board.

Solar power may charge the batteries while the boat is being timed or raced over the measured distance.

599 - ELECTRIC BOAT SAFETY RULES

599.01 - ELECTRIC BOATS

Exposed terminals shall be taped over or otherwise insulated to prevent accidental short circuits.

Batteries must be securely fastened to the boat in such manner that if the boat were to capsize, the batteries would remain with the hull.

Boats must incorporate enough flotation to ensure that, in the event of accident, the boat will float enough to be salvaged.

All electric boats in competition must be equipped with a physical disconnect. The purpose of the disconnect is to stop the motor, disable the electric system and limit power to safe levels in the event of an accident.

In any boat operating at voltages above 72 volts, such disconnect must be incorporated into the power system in a manner which splits battery power into packages of 72 volts or less.

The disconnect must consist of a plug and tether combination. The plug fits an in-line receptacle completing the electrical circuit and allowing it to be energised. The tether must be two metres or less in length and made of or attached to the plug by material not subject to heat damage such as melting or becoming brittle.

All safety tethers must be securely attached to the driver at all times whilst the boat and the driver are under way.

At any time an electric boat is launched, recovered, disabled on the course or is under tow, the disconnect plug shall be removed from the in-line receptacle.

A caution decal must be affixed in the vicinity of the disconnect receptacle, and to the bottom or non-trip at the same approximate station line. Its purpose is to warn rescuers against handling the boat at that point and possibly completing the electrical circuit.

All exposed drives and drive trains must be adequately covered or shielded with appropriate guards or covers.

Commutator shielding is recommended in all electric boats.

Protective clothing must be worn by all drivers participating in electric events.

599.02 - ELECTRIC BOAT RACING RULES

Starts must be dead motor starts. Drivers must draw for lane positions.

Classes and hulls shall be in conformance with class rules.

Electric boat drivers who's boats are not on plane by the time the lead boat reaches a predetermined point must move off course and stop. The shutdown point will be determined by the drivers prior to the drivers meeting. Failure of a driver complying with this rule will result in a one race suspension.

600 - RECORDS AND PERFORMANCES

600.01 - GENERAL

All record trials and their control are submitted to the following rules.

The record belongs personally to the driver who has established or beaten it. The record is entered under the name and nationality of the driver.

Any race against the clock, and called kilometre or mile trials or any similar name is prohibited if not conducted in accordance with these rules.

Combining speed records with distance records is not allowed.

No direct or indirect aid is to be provided to the driver who attempts a record.

600.02

World speed records, hour records, distance records and competition records are all records open to all boats and aquabikes of international classes adopted by U.I.M.

600.03

National records recognised by U.I.M. are the records established by boats of national classes duly recognised by the national authority (the rules of which have been approved by U.I.M.). The Certificate differs from those issued for World Records.

600.04

The World's Unrestricted Water Speed Record is awarded to the fastest boat in the world piloted by a driver, irrespective of the class of boat. This record is established in conformity with U.I.M. rules, including a UIM

registered reinforced cockpit. Following rules are recommended: 509.05 (Hans Device and seat); 509.16 (canopies); 509.20 (air supply).

600.05 - ELECTRIC BOAT WATER SPEED TRIALS RULES

Power source for water speed trials shall be multiples of commercially available batteries of any type. Motors are restricted to direct current (dc) only.

Boats may be towed to an on-course starting point, but may not be towed to achieve a planning attitude. Any such assistance will result in the disqualification of the offending boat.

Once at the starting point, all tenders and assisting craft must be removed to positions away from the racing line.

Recharging or replacement of batteries between initial and return runs while attempting a record is not permitted.

601 - CLASSES ELIGIBLE FOR RECORDS

601.01

World records may be attempted with the following craft:

- All U.I.M. series and classes
- American Powerboat Association classes
- Prototypes

601.02

A boat can establish a record in its own class only.

601.03 - FROZEN RECORDS

When a class is modified so as to reduce the performance of the class, for example by:

- reducing the cylinder capacity,
- restricting the tuning permitted,
- restricting fuel permitted,
- introducing a minimum weight,
- increasing the minimum weight,
- or any other means,

the records established before the modification comes into force may be frozen on the determination of the Sports Commission and a new series of records will be started.

All proposal for new rules, rule changes and U.I.M. General Assembly minutes shall state:

- whether or not records will be frozen,
- the classes to be frozen
- the date(s) when the classes are to be frozen.

601.04 - QUALIFICATION

For offshore records a boat must have completed the course, taken the chequered flag and finished first, second or third, in a U.I.M. World or U.I.M. Continental Championship race in the class to be attempted and after the date when the class was last frozen.

602 - DEFINITION OF UNITS

602.01 - TIME, DISTANCE AND SPEEDS

The hour is the twenty-fourth part of a terrestrial day. The symbol is letter "h".

The minute of time is the sixtieth part of one hour. The symbol is letters "mn";

The second of time is the sixtieth part of one minute. The symbol is the letter "s".

nautical mile	=	nm
statute mile	=	st.m
kilometre	=	km
nautical mile per hour	=	knot
statute mile per hour	=	mph
kilometre per hour	=	kmh

602.02 - STATUTE MILE, NAUTICAL MILE AND KILOMETRE

The statute mile is an Anglo-Saxon measure.

The nautical mile is used at sea.

The knot is not a unit of length; it expresses the speed of one nautical mile per hour.

One statute mile (st.m)	=	5280 feet = 0,8690 nm = 1,609.3 km
One nautical mile (nm)	=	6080 feet = 1,852 km = 1,1508 st.m
One kilometre	=	3280.844 feet = 1000 metres

604 - BASES

604.01

Records may only be established on bases recognised by National Authorities and notified to the U.I.M. in accordance with these rules.

604.02

The base is measured and certified by an official surveyor holding a certificate of competence from a recognised institute, in the presence of a delegate of the National Authority.

The base must be measured by triangulation or electronic distance measuring equipment (EDM), which must have a first class certificate delivered by an Observatory or similar authority. This certificate must not be older than two years.

The official surveyor provides a certificate in duplicate in which the strict adherence to the above requirements is certified.

The certificate is signed by the surveyor and countersigned by the delegate of the National Authority. One of the copies is for retention by the National Authority for its special national records files and the other is sent to U.I.M. for its special world record files.

The base for a record must be a fixed base, as laid out for a national authority or must be measured for a special occasion in waters designated by the driver. It must be defined by fixed marks ashore.

604.03

No distinction is made between records established on the sea, rivers or lakes. Records must not to be attempted during the period between half an hour before and half an hour after a change of direction in flow of water over the course (change of tidal flow).

604.04

Any expenses incurred in the laying of a temporary course are defrayed by the entrant attempting the record.

604.05

For speed records there shall be only one attempt on the course at anyone time.

An attempt must not start until the director of the trial is satisfied that effective rescue boats are on the course.

605 - CALCULATION OF SPEED

605.01

The National Authority calculates the speed from the data provided by timekeepers. The speed is to be shown in kilometres per hour (kmh) and statute miles per hour (mph), even when the attempt takes place on a course of one nautical mile;

The duration of each run is obtained by taking the arithmetical mean of the times recorded by two sets of timing devices the mean time being given to one tenth of a second.

Should one of the timing devices stop or one of the signals fail and only one duration be registered, this duration will be accepted.

605.02

The duration so obtained serve to calculate the speed of each run. Only two decimal places are to be used.

605.03

The speed of the trial is the arithmetical mean of the speeds, two decimal places being used.

605.04

For speed records established on a distance of one nautical mile (1nm= 1.852 km = 1.1508 st.m) the following constants are to be used:

Where t is the time in seconds.

to obtain the speed in mph: $4141,9 \div t$

to obtain the speed in kmh: $6667,1 \div t$

606 - MARGIN REQUIRED

A record will be valid only if its speed at least equals the speed of the previous record multiplied by 1.003.

607 - MOTORS

607.01

All accessories and/or elements required by the racing rules for each class of boat attempting to establish or improve a record must be on board during said attempt.

607.02

A boat which holds two certificates for two different classes is entitled to establish world records in those two classes, but shall make two distinct trials, one for each class.

607.03

Immediately after the record trial, the motor(s) or engine(s) must be sealed with a distinctive seal in the presence of the officials who have witnessed the trial.

607.04

Within 48 hours of the trial, the two measurers must check that the hulls, motors and equipment are in conformity with the specifications of their class, and this inspection must be carried out in the presence of the Officer of the Day or an Official specially appointed by the National Authority.

607.05

When attempting to break a U.I.M. class record, the noise level of the motor shall not exceed the authorised level (rule. 504).

607.06

It is mandatory to perform a noise measurement during record runs. The results of the measurements must be included in the signed measurers' report, sent to U.I.M.

608 - REQUEST TO ORGANISE**608.01**

All applications for records trials must be made in writing to the National Authority at least one week before the trial and must be accompanied by the fee stipulated by the National Authority.

The National Authority applies to the U.I.M. for homologation of records.

608.02

Only records established under the direct control of a National Authority affiliated to U.I.M. can be recognised.

608.03

Each National Authority decides on the application for records to be established on its territory. The National Authority may refuse to consider a record application but must then explain the reasons in writing.

The National Authority indicates the validity of the record permit.

608.04

It is the duty of the driver to accept responsibility for any safety measures deemed necessary for this attempt.

The officials will not accept any responsibility, they will only record the results and ensure that the rules are complied with.

609 - OFFICIALS**609.01**

The National Authority shall appoint an Official Observer and other duly qualified persons to hold the official functions.

An official so nominated shall not hold any other office than that to which he was nominated. An official shall not himself establish a record.

609.02

The official timekeepers and officials may receive payment for their services at rates fixed by the National Authority.

609.03

Time keeping may only be carried out by timekeepers and officials who have been recognised and authorised by the appropriate National Authority.

The stop-watches or any other apparatus employed must have a first-class certificate delivered by an observatory or similar authority. This certificate must not be older than two years.

Each timekeeper hands to the National Authority a signed report of the record attempt, countersigned by the official observer.

609.04

Timing from aboard anchored boats or aboard competing boats is not allowed.

610 - SPEED RECORDS**610.01**

There is only one world record per class. This record can be established over the nautical mile, land mile or the kilometre, for aquabikes the distance may be 500 metres.

610.02

The course is covered once in each direction consecutively.

The course is to be marked at either end by two posts in solid material, put up on shore with approved distinguishing marks affixed to them. The two lines uniting the two pairs of posts are parallel to each other and at right angles to the line of the measured course. Steering marks may be placed wherever needed.

90 1 mile 90

1 kilometre

1 statute mile

610.03

In wide rivers and lakes, the width of the course may be marked off at each end by two buoys, moored at a distance of one hundred metres from each other. The boats must run between these buoys.

610.04

Timing is to be one tenth of a second up to 200 kmh. Above 200 kmh timing is to be by photoelectrical or similar apparatus to one hundredth of a second.

There must be a timekeeper and a timekeeper observer at each position.

Individual timers may be used at each position or a single timer electrically activated from each position.

Where two timers are used at a position the time is the average of the two timers.

The times of day of each attempt must be recorded.

The time elapsing between the two runs must not exceed 20 minutes except for jet attempts when the permitted interval is one hour.

610.05

A driver may re-start an attempt because of breakdown or other reason and may stop the engine or boat between runs.

If the attempt has not been completed within four hours of a starting time fixed by the National Authority, the officer in charge may stop the trial.

611 - DISTANCE RECORDS**611.01**

Distance records are established on a total course of twelve nautical miles for the outboard series and twenty-four nautical miles for other series, and six nautical miles for aquabikes.

611.02

In distance records, the base is covered up and down successively in even numbers and the turns are not included in the distance.

The course for distance records may be:

- a course established for speed records;
- a base of three nautical miles maximum, in straight lines with buoys placed at the corners if necessary, no corner to be less than 135 degrees.

The buoys placed at the corners must always be rounded.

611.03

Any base must be defined by two posts set in concrete at either end.

611.04

Timing is to be to one tenth of a second.

The timing of distance records is done by a timekeeper with two timing devices at the starting line. He is assisted by two officials, one with him and one at the other end.

611.05

Stopping the motor or the boat during a distance record attempt is prohibited.

612 - HOUR RECORDS**612.01**

The following international and national records are recognised by U.I.M.: 1, 2, 3, 4, 6, 9, 12 and 24 hours duration records for all the series recognised by U.I.M.

The homologation of a record of lesser duration than that applied for may be granted, but only within such limits as provided for by the above rule.

612.02

The base must not exceed six nautical mile from station to station, that is to say twelve nautical miles up and down. For aquabikes only, the distance may be 3 nautical miles from station to station that is to say 6 nautical miles up and down.

612.03

The base is defined by two posts set in concrete at either end.

612.04

The boat may be driven by more than one driver, but their names must be filed in the record application.

612.05

Repairs and adjustments which can be carried out on board may be effected on the course.

The same motor or engine and hull must be used throughout the trial.

On the other hand, repairs that cannot be effected on board and refuelling and changing of drivers must be effected at the control station and are to be supervised by an official.

612.06

Any time during which a boat stops during an attempt is included in the elapsed time for the attempt.

Turns are included in the course and are consequently not excluded from the timing.

612.07

Timing is carried out by one or several timekeepers with two timing devices stationed at the start. The timekeeper is assisted by two officials, one stationed with him and one stationed at the other end.

612.08

A driver can claim several different hour records during one trial by selecting the best series of consecutive laps.

612.09

The boat must cross the finishing line at the end of the lap (the last lap) during which the record time has elapsed.

The average speed of the last lap is calculated and the distance which corresponds to the time still to be run is added to the distance covered at the end of the penultimate lap.

The result is shown as the distance covered in the record time and the average speed for that distance.

612.10

Example for a two hour record on a base of six nautical miles (nm), twelve nautical miles per lap:

12 nautical miles (nm) x 1.1508 = 13.81 statute miles (st.m)

boat completes 8 laps in	1h 54mn 40s	= 110.48 st.m
ninth lap completed in	13mn 50s	= 830 s
time balance	5 mn 20s	= 320 s
distance balance	= 13,81 st.m: 830x320	= 5.32 st.m
	Total distance in 2 h	= 115.80 st.m
	Average speed = 115.80 ÷ 2	= 57.90 mph

613 - WORLD COMPETITION RECORDS**613.01**

The U.I.M. recognises world records of 3, 5, 10 and 15 statute miles in races for all U.I.M. circuit classes.

No other records may be established during a race.

Unlimited hydroplanes only are entitled to statute mile records established on:

- a single lap course (two laps for APBA Gold Cup races) while qualifying or racing,
- total heat average speed while racing.

614 - PERFORMANCE CERTIFICATES**614.01**

U.I.M. may issue Performance Certificates for the best heats made during races for the principal international trophies.

614.02

Application for these is to be made by the National Authority of the country where the race took place and the accuracy of the results, timing course and class is to be certified by them.

614.03

U.I.M. only recognise the results which beat previous performances.

614.04

The amount of the fee for Performance Certificate is decided upon annually by the General Assembly.

614.05

U.I.M. may issue a performance Certificate for speed trials made by boats not included in U.I.M. classes. These trials must, however, be made in accordance with U.I.M. rules.

U.I.M. award Performance certificates for boats of the Production boats Series having established or broken speed, duration, distance or competition records according to the Record Rules.

614.06

For these performances, it is not permissible to remove any of the boat's accessories, or items of comfort, provided by the builder and these are compulsory for racing.

U.I.M. may award Performance certificates for any of the offshore classes, international and national, established at sea on properly measured runs.

615 - HOMOLOGATION OF RECORDS**615.01**

Only records homologated by U.I.M. are considered as World Records.

Only records established under the direct control of a National Authority affiliated to U.I.M. can be recognised.

615.02

If a record has been established on the territory of two National Authorities, it will be entered as a record by the National Authority on whose territory the start was made.

As soon as a record trial has taken place, the National Authority communicate the results to the Secretary General of U.I.M. by fax and confirm it by letter.

The information has no official character and is only transmitted to such National Authorities as apply for it, in order to avoid useless trials.

615.04

The timekeepers and measurers must complete the official U.I.M. record application form which must be signed as correct by OOD and be sent to the National Authority within three days of the trial, seven days for APBA controlled classes.

The National Authority transmits the application for homologation, together with other necessary papers, to the U.I.M. no later than four weeks after the trial, sixteen weeks for APBA controlled classes.

615.05

For a request for homologation to be considered by the U.I.M., the National Authority must send:

- a plan of the course if not already in possession of the U.I.M.,

- the completed official U.I.M. application form which must include any National Authority calculations,
- a copy of the boat's measurement certificate,
- a photograph of the boat under way with the colours, inscriptions, etc. noted on the reverse ; also to be noted on the reverse, the driver's name, class and speed achieved,
- a list of the full names of the officials with, at least, the names of the Timekeepers, Measurers, Rescue Officer, OOD and Observer,
- for offshore boats, a copy of the results in which the boat qualified, as per U.I.M. rule 601.04,
- for attempts on tidal waters, the calculation stating the times of the changes of direction of water along the course (changes in tidal flow) and the source of the information,
- a cheque for the amount due

615.06

The recognition fee is fixed annually by the General Assembly.

615.07

Pending the official confirmation by U.I.M., neither the driver, builder nor any other shall publish or cause to be published, circulate or cause to be circulated, the results of the trial, until the delegate of the National Authority has given the actual results in writing, after checking the calculations in the presence of timekeepers.

Even when such authorisation has been received, results may only be published with the addition of the words "Subject to official certification by U.I.M." in as large and prominent type as that in which any part of the notification itself is printed.

Neglect to comply with the above regulations automatically entails the refusal to recognise the record. The National Authority have the right to penalise whoever is responsible.

615.08

U.I.M. issues annually a list of world records, changes being made known, when they occur, by means of newsletters.

U.I.M. keeps a registered list of all word records and delivers a certificate for each new record.

700 - ENVIRONMENT

701 - NOISE LEVEL

Every driver is responsible that his engine(s) does not exceed noise levels at all times as specified in Rule 504.

NOISE CONTROL

All race and record attempt organisers are responsible that noise control rule 504 is enforced.

702 - EMISSIONS

To reduce emissions as much as possible, all drivers are recommended to use lead free petrol and biodegradable lubrication oil.

703 - RE-FUELLING

Every care must be taken not to spill fuel or oil. An absorbent carpet to avoid any spillage on to the ground must be used.

704 - ENVIRONMENTAL CARE IN RACE AREAS

704.1

Every organiser must appoint a responsible person or persons to make necessary arrangements to control the environment of the whole race area including spectator areas.

704.2

There must be large containers in the pits where waste, such as cans, containers, oil waste can be placed.

One person must be responsible for this and to authorise the proper removal after the race meeting with the Local Authorities.

800 - CUPS AND TROPHIES

800.01 - INTERNATIONAL CUPS

The National Authorities must send to the Secretary of the U.I.M. a copy of their international Cup Rules, Year Books, official Statutes and other publications. These documents will be held at the disposal of all National Authorities.

801 - ALFRED BUYSSE TROPHY

The Alfred Buysse Trophy is perpetual.

The present regulations may be modified by the donor and after him by the General Assembly.

The holder of the cup must insure its safe keeping for a year and return it personally to the National Authority.

Two plaques, presented to winners, remain their property.

The Trophy goes to the driver who has the highest number of points from titled international meetings in the list established by the Sports Commission. The latter decides which of the classes entered will count for the competition.

Only the points obtained between 1st of November and 31 st of October by the first five drivers of each competition and of which the results have been properly communicated to the Secretary of the U.I.M. by the National Authority are taken into consideration.

The U.I.M. Secretariat publishes the results in the first bulletin following the receipt.

The interested National Authorities must indicate at the beginning of the year, which are the meetings held in their country counting for the Buysse Trophy.

All results counting for the trophy are to be sent to the U.I.M. Secretariat within a fortnight after each race.

802 - JOHN WARD TROPHY

The Trophy created in 1925 is a work of art worth 762 €. The funds were subscribed by several well-doers and the affiliated National Authorities.

It is attributed to the 0 500 class of racing outboards but the Council has the right to attribute the Trophy to another class subject to one year's notice.

The John Ward Trophy may be raced for only by drivers holding a driver's licence issued by their National Authority.

The John Ward Trophy is raced for annually during an international titled meeting.

There is only one race for the John Ward Trophy each year.

It is not allowed to combine this race with a cup or trophy bearing another name. However, the organisers may give cups and other prizes to the competitors.

The John Ward Trophy is perpetual. The organisers hand to the winner a cup bearing the inscription "John Ward Trophy - Anno..." as a souvenir.

Because of the fragility of the Trophy, the Union has decided not to dispatch it anymore to winners.

The race is in circuit, in two heats of 9 kilometres or 5nm each. Classification on points system as per rule 318.01 of the Racing rules. In case of a dead heat, the total elapsed times decide.

The Organising Committee must transmit the results to the Secretariat of the Union, without delay.

If the National Authority who has undertaken to organise the race cannot do so, they at once notify the Secretariat of the U.I.M. who may then offer the organisation to another National Authority.

The Trophy remains the property of the U.I.M.

In case the Union is dissolved, the extraordinary General Meeting held as per statutes decides what to do with it.

Any dispute concerning the attribution of the Trophy must be placed before the U.I.M. by the National Authority. The decision of the Union is final.

The present rules can be altered only by the General Assembly of the U.I.M.

The organisation of the meeting is decided by priority of the alphabetic rotation of the affiliated nations, the French names of these nations being considered to this effect.

Should a nation decline the organisation, the nation which comes next in rotation is taken into consideration.

Should a nation enter the race on the Calendar for a given year but fail to organise it, said Nation is considered as having held the race, as far as the rotation is concerned.

The attribution of the John Ward Trophy must be done under the same conditions as for the Championships.

803 - BOUCQUEY TROPHY

Same rules as Buysse Trophy.

The class is 0-850cc.

804 - DIETER KONIG MEMORIAL

Will be attributed to the F.500. The three first classified at the general classification will receive respectively a golden, silver and bronze medal.

805 - JOHN HILL MEMORIAL

A replica of the John Hill Memorial Trophy will be attributed each year at the last European race of the F1 World Championship. The criteria to allocate the Trophy will be "sportsmanship" and the allocation will be done by the F1 Committee. The original Trophy is kept at the U.I.M. office.

900 - U.I.M. RULES FOR RIVER MARATHON RACING

900.1 - GENERAL

1. River Marathon Race is a one day for classes: P and PR or a multiple day motor boat Race covering a predetermined distance per day with an overnight stop(s) at a designated area for refueling, repairs and rest if needed. The winner is the boat which uses the least elapsed time in covering the total prescribed distance. There will be an Overall Winner (first, second and third places), they will be the boats which start and finish all of the legs, under their own power, and they do it in the least amount of time, regardless of their class (the boat and/or the driver must not be changed).
2. International racing is open to the classes mentioned in Rule 900.15. Titles shall be given to these classes only. Other local classes can be invited by the National Authorities and or the organizers of River Marathon Races, if so, the classes and the capacity of the engines must be indicated in the Advance Program.
3. An entry fee may be set for all classes including those which may have been given a U.I.M. international Title and must be indicated in the Advance Program.
4. An Advance Programme must be sent by the organisers of an international River Marathon Race to other National Authorities and to the U.I.M. Office at least 90 days before the race.

900.2 - APPLICABLE RULES

1. River Marathon Racing is governed by these rules and by U.I.M. Circuit rule Groups 100, 200, 400.
2. In cases where these rules and the rules contained in the Circuit rule Groups are in conflict, these River Marathon rules will prevail.

- Organisers of international races may prescribe deviations from the U.I.M. Group 100, 200 and 400 rules only when they are called for by national legislation or by safety or environmental requirements, or when the organisers deem those rules unsuitable for River Marathon Racing in general. Such deviations can, however, be applied only if they have been published in the Advance Programme.

900.3 - RACE COURSE

- The length of the race course must be such that it can be covered in a maximum of six days of racing, excluding possible lay days which can only be a maximum of 50% of the racing days. The minimum duration of a race is two days (for inflatable boats – one day as per rule 900.1), excluding a possible lay-day.
- A day's race course can consist of more than one leg and it can be done in the same or different rivers. The organizers must allow sufficient time between each leg for the racers to get to the finish line, it should be proportional to the length of the leg. The time allowed must be indicated in the Advance Program and must be confirmed at the driver's briefing of each particular day and/or leg. If the race course is divided into a minimum of two legs, the distance to be raced in each leg must be such that it can be covered between official sunrise and sunset of the region in question.
- The race course does not need to be registered or officially measured by the U.I.M.
- A River Race can only be done on a rivers class I, II and III. Conditions on a river may vary from time to time during the year. In the Advance Program it must be indicated the class of the river for each of the legs of the race.
- The Race Committee can postpone a day's race for 24 hours, if the weather conditions and / or river conditions are not adequate, according to Rule 309.

900.4 - CREW

- Any race boat crew shall be comprised of no less than 2 members, ***one of them must be designated as the driver in the entry form.***
The boat driver must be in possession of a current racing license issued by his National Authority.
- All crew members full names and home addresses must be communicated to the race organisers when the boats official entry to the race is made.
- Changes of the crew members during the race shall be made with the explicit consent of the Race Committee except for the driver.***
- Each crew shall have one crew member designated as Captain who is responsible for the boat and all actions of its crew. All matters related to the race shall be conducted through the Captain.
- The minimum age of a crew member is 18 years, for younger crew-members (16years or older), they can race only with a written authorization from their parents.

900.5 - EQUIPMENT

In order to race, each race boat must be equipped with the following:

- A minimum of two oars or paddles
- A minimum of two ropes, one measuring 12 mm (1/2 inches) in diameter and 10 m (33 ft) in length to be used for towing, another rope measuring at least 10 mm (3/8 inches) in diameter and 15 m (50 ft) in length, it must have at one end a flotation device and the other end must be fastened to the structure of the racing boat.
- A set of flags: red and yellow, measuring each one at least 400 x 600 mm (16 x 24 inches) and attached to a pole 800 mm (31 inches) long.
- An emergency first aid kit
- A repair kit with necessary tools

- f) Two readily accessible fire extinguishers (ABC or equivalent) well secured to the boat having a minimum capacity each of 2.25 kg. (5 lb.).
- g) Life jackets for all crew members conforming to minimum specifications as stipulated in Rule 205.06.
- h) Crash helmets conforming to rule 205.07, for all crew members.
- i) Clothing of any flammable material such as plastic or nylon, can be worn by crew members on top of the racing suit only in weather affected areas. The racing suit can be a one or two piece suit, it should be made of wool or cotton, any flame retardant material is highly recommended. Regular length pants and long sleeves are required.
- j) The use of helmet to life jacket back or side straps are highly recommended.
- k) The crew must wear eye protection during the race, it is recommended that it is in the form of shatter proof material (plastic goggles or it could be a full face protection).

900.6 - TECHNICAL SAFETY REGULATIONS

1. Fuel tanks must conform to the following when applicable:
 - a) Removable fuel tanks such as those used for outboards must have quick disconnect couplers to permit such tanks to be filled at a remote location, away from the boat
 - b) a fuel tank must be properly grounded. It must have a minimum 50 mm (2 inch) diameter spout to fit the fuel tender. The spout must be fixed to the boat.
 - c) fixed fuel tanks must be properly vented to the outside of the boat
 - d) all fuel tanks must be securely fastened.
2. Any water outlets exiting from the side of the boat must be directed horizontally or downward.
3. All propeller driven race boats must be equipped with a kill switch to stop the engine if the driver is separated from the boat.

4. For totally enclosed inboard engines the bilge must contain a blower or must be well ventilated.
5. It is recommended that all carburetors or induction inlets have flame arrestors, they should stay on the engine at all times when the engine is running.
6. All moving mechanical parts such as drive shafts, flywheels, belts, pulleys, etc., have a secure cover.
7. All Inboard engine boats and Outboard engine boats, must have a battery isolator switch. The switch should be accessible to the racing crew and must be marked by a red triangle 75mm (3 inches) sides.
8. There should not be any sharp elements or protruding elements in the boat were the crew is seating while racing the boat, as stipulated in Rule 509.09
9. ***It is recommended that the steering cables must be made of flexible stainless steel wire with a minimum diameter of 4.7 mm (3/16"). It is also recommended that the cables run from the steering wheel to the back through the middle of the race hull, in a manner to avoid hitting the race crew if they are pulled to the back.***

900.7 - INSPECTION PROCEDURES

1. Motors, hulls and compulsory equipment subject to these rules shall be inspected prior to racing and after any of the legs have been finished to assure compliance with these rules. The technical inspection shall be conducted by designated inspectors who must report compliance or non-compliance with these rules.
2. The engine block may be given a unique identification mark to facilitate enforcement of Rule 900.8.13.
3. Each race boat and support boat, must go through a technical and safety inspection before the race. All equipment shall be available for inspection during the time and at the location specified for technical inspection. If any equipment is found not to be in compliance with

these rules, or if the captain or driver has failed to comply with the spirit or letter of these rules, the Race Committee may rescind the entry. Correction or substitution may be permitted if made prior to the start of the race. The start of the race shall not be delayed to allow compliance.

4. Immediately after crossing the finish line of the last leg of the race, contestants shall report with their boats and motors to the inspector at the location designated by the Race Committee. The boats and motors shall remain in the custody of the inspector(s) until dismissed. Any contestant(s) refusing to comply with the orders of the Chief Inspector or who violates the provisions of this rule may be disqualified by the Race Committee.
5. The Chief Inspector shall have the power, after the finish of the race, to order any contestant(s) to dismantle the boat or motor for inspection or measurement at the designated area. For the motor the Chief Inspector will be able to measure the engine capacity with a meter and/or gauge (if available), if the motor's capacity is on the upper limit, it will be to his discretion if the motor should or should not be dismantled. The cost of dismantling and assembling the boat or the motor should be paid by the contestant.
6. Any boat which after it has been inspected and according to its motor capacity should have raced in a bigger class, will be disqualified from the race by the Race Committee.

900.8 - GENERAL RACING RULES

1. Definitions:

- a) Race Course: those rivers or waters, or segments thereof, between the first starting line and the last finish line as designated by the Race Committee
- b) Leg: that segment of the race course between the starting line and finish line as designated for any particular part of the race.

- c) Starting Line: the imaginary band, approximately one meter (three feet) in width, as drawn from the starting flag person to a point across the river or water as described by the Race Director at the daily drivers meeting
 - (1) To be ahead of the starting line implies being on the leg between the starting and finish lines so designated for that leg
 - (2) To be behind the starting line implies being out of the leg designated for that day.
- d) Staging area: that segment of the water immediately behind the starting line and continuing away from the starting line for a distance of approximately 50 meters (55 yards).
- e) Holding area: that area behind the staging area and continuing for a reasonable distance away from the staging area.
- f) Finish line: the imaginary band, approximately one meter (three feet) in width, drawn from the finish flag person to a point across and approximately perpendicular to the bank of the water. The finish line will be described at the drivers' meeting prior to the beginning of each leg.
- g) Under its own power: The boat is in motion and not assisted by any other powered vehicle or craft. When starting a leg it can not be done by the motion generated from the water current and/or the rowing action of the crew. On finishing a leg it can be done by motion generated from the water current and / or the rowing action of the crew considering that the boat has run all of the leg without any external assistance. This rule can not be changed in the Advance Program.
- h) Under the control of its own crew: The crew is deemed to be able to control the destiny of its own boat.
- i) Wilfully: a boat is under its own power and under the control of its crew.
- j) Being in tow (taking a tow): the boat is put into, or is in motion with the assistance (in any way) of, another powered vehicle or craft.

- k) Allowed starting period: that period of time between a boat's designated starting time and the official closing of the starting line.
 - l) Pit area: that area of the parking lot designated by the Race Committee for parking of racing boats, trailers and support vehicles. Each entrant will have a designated parking space for one boat and trailer in addition to an adjacent space for a support vehicle. Also, any area where boats are parked between legs of the race will be considered a pit area.
 - m) Long block: the engine block, heads, valve train, crankshaft, rods, pistons, camshaft, and timing drive assembly.
2. A Drivers' Meeting will be held prior to each leg of the race at the advertised time. It is compulsory that the driver of each boat entered in the next leg attend the Drivers' Meeting. A roll call will be held and a 15 minute penalty assessed for drivers being absent when their name is called.
 3. The life jacket and helmet must be worn by everyone in a race boat at all time while the boat is in motion under its own power, this implies during racing, testing or tuning. Violation of this rule will result in assessment of a 15 minute penalty.
 4. Drinking alcoholic beverages or using intoxicating drugs by any contestant or race official prior to completion of racing is strictly prohibited. No boat (race or safety) driver shall operate a boat if alcoholic beverages or intoxicating drugs have been consumed. Violation of this rule will result in total disqualification or suspension of official duties.
 5. The use of offensive language by a crew member towards any other person or crew member or race officials will not be tolerated. Violation of this rule will result in assessment of a minimum ten minute penalty.
 6. Intentionally causing damage to another boat or intentionally causing bodily harm to a crew member of another boat will not be tolerated. Anyone failing to comply with this rule will be totally disqualified.
 7. A crew member must obey the instructions of any Race official. Failure to do so will result up to total disqualification from the race.

8. The possession of firearms at any time during the event by any crew member is strictly prohibited. Violation of this rule will result in total disqualification.
9. No person shall provide or receive assistance from the air or by radio during the race. Failure to observe this rule will result in the contestant being disqualified for the leg. Global Positioning Systems (GPS) are allowed.
10. After the boat has passed inspection, the Race Committee may re-inspect it to insure that all of its compulsory equipment is present and technical specifications are in compliance with the rules.
11. Smoking is prohibited in the designated pit area and / or onboard a boat and / or in an area 3 m (15 ft) around the boat. Violation of this rule by any crew or member of the team will result in a penalty to the race boat. This penalty will be assessed by the race officials and can be of 15 minutes to disqualification of one particular leg.
12. The hull shall not be replaced during the race. Failure to abide by this rule will result in total disqualification from the race.
13. The organiser can decide to use Rule A or Rule B provided it is printed in the Advance Programme.

RULE A The engine block must not be changed during the race.

RULE B The complete engine can be changed once only during the race in the case of failure, provided he notifies the chief inspector who must authorize the change and inspect the engine to be replaced as well as the second one, for class homologation and give new identification numbers and / or mark. The second engine block cannot be replaced during the rest of the race.

The initial engine block cannot be rebuilt and used for the remainder of the race.

Failure to observe any part of this rule will result in total disqualification from the race.

Failure of the Advance Program to state any decision then rule A will apply.

14. A boat which has been disqualified for a leg, may continue in the race, for the disqualified leg it will have the same time as the boats which did not start (DNS) Rule 900.10.13.
15. Any issue not foreseen by these rules will be decided by the Race Committee, according to Rule 200.02.
16. The organizers must specify in the Advance Program if there will be fuel available for the race and if the fuel for the first leg is included, what type and / or quality of fuel and under what terms and conditions it will be supplied to the racing boats.
17. Fuel can be inspected by the Chief Inspector at any time during the race, this will be done according to the regulations and procedures indicated in Rule 508. Failure to let the fuel be inspected will result in total disqualification from the race. Regular Pump fuel refers to the fuel which anyone can buy on a regular basis in any fuel station at the race site, the octanage considered for the race, will be the highest available at these stations.
18. The race boat must have a set of race numbers on each side and one on the bow of the boat. The racing numbers size on the boat must comply with Rule 206.02. The colors can be according to this rule or they can be of another color with a contrasting surface surrounding them, or they could have an outline of at least 4 cm (1 ? inches) wide of a contrasting color.

900.9 - FLAG SIGNALS

- 1) Red Flag: raised and displayed by a safety boat or a race boat implies danger or emergency. All approaching boats must stop. It is the responsibility of a member of the safety boat, or race boat crew member if a safety boat is not present, to maintain a record of the time the boat is stopped. After stopping for a red flag, a race boat may not continue with the race until a safety boat has arrived and granted permission to continue the race even if the red flag was unjustly raised. Prior to granting permission to continue, the safety boat must record all boats' times out and forward them to the finish line officials for the leg. If a boat fails to wait for a safety boat before

proceeding with the race, the time out will not be acknowledged. The boat which makes improper use of the red flag, will be disqualified from the race by the Race Committee.

- 2) Yellow Flag: A safety boat member or race boat crew may raise its yellow flag only when they have a problem, when one of the crew is in the water, or they become an obstacle in the race course and the boat prevents or endangers the safe passage of oncoming boats or endangers the life of any or all the crew members. When a yellow flag is displayed the approaching boats should proceed with caution until they pass the problem area. The improper use of the flag will result in total disqualification of the offending boat for the leg.
- 3) Black Flag: do not leave the pit area - return to the pit area.
- 4) White Flag: It will be raised at the starting line, 2 (two) minutes before the starting time of the first race boat of that leg and lowered 10 seconds before the start
- 5) Green Flag: It will be raised for each boat at the starting line, 10 seconds before the starting time and lowered at the starting time. It will be raised again 10 seconds before the starting time of the following boat.
- 6) Black and White Chequered Flag: raised with the arrival of a boat at the finish line and lowered when the boat crosses the finish line.

900.10 - STARTING

1. A ramp official will be present at the launching site, prior to the start of the race, to assure orderly and timely launching. Each boat may be given a launch time, each boat will have five minutes to clear the ramp / launch area. Failure to do so will result in a penalty of 15 minutes. Emergency situations requiring longer times will not be subject to the penalty at the discretion of the ramp official.
2. The starting order for other than mass starts, shall be determined by drawing lots. Subsequent starting orders for other than mass starts will be determined from the cumulative elapsed times for previous legs. The starting order will progress from the fastest time to the

slowest time. The starting line officials may, at their discretion, alter the order of the start if conditions so warrant. At the starting line the numbers of the next boat to start should be displayed to the racers, the size of the numbers should be at least of 300 mm (12 inches) high and they must be black on a white surface.

3. A leg is deemed to be open to racing on completion of the drivers meeting. Thereafter, and until the leg is officially closed as per Rule 900.12.3, the leg is deemed to be open to racing.
4. All boats must be in the water and behind the starting line when a leg opens to racing. Any boat which is in the water and ahead of the starting line at this time will be deemed to be wrongfully on the leg and can be assessed a penalty of 3 minutes. In order to get behind the starting line without incurring in this penalty, such boat must proceed in accordance with Rule 900.10.12.
5. *Reserve number*
6. While the leg is open to racing, if for reasons beyond the control of the crew, a boat crossed the starting line, prior to its designated starting time, it will be wrongfully on the leg, the crew must raise the yellow flag, if not it will be assessed a penalty of 2 minutes. When possible will have to return behind the starting line in accordance with Rule 900.10.12, in order to take his start.
7. A boat will be assessed a penalty of 1 minute per second if it wilfully crosses the starting line from the staging area prior to its designated starting time.
8. A boat is deemed to have started a leg if it wilfully crosses the starting line from the staging area at any time after the ten (10) second flag (for its designated start) is raised and before the starting line is closed.
9. Regardless of when a boat starts a leg, it will begin to accumulate a running time for that leg from the time that it was designated to start.
10. A boat that is unable to start at its designated starting time may remain in the staging area provided that it does not wilfully obstruct or impede a boat that is rightfully in the staging area. Failure to abide

by this rule will result in assessment of a penalty of 15 minutes up to disqualification for the leg.

11. The boat that is unable to start at its designated starting time may cross the starting line from the staging area at any time within the allowed starting period provided that the ten second (green) flag has not been raised for another boat. Failure to abide by this rule will result in the assessment of a penalty of 15 minutes.
12. In order to return, or get behind the starting line when the starting line is officially open, a boat, wrongfully on a leg, must comply with the following procedures whenever applicable.
 - (a) If a boat is out of sight of the starting line, it may proceed with precaution at a reasonable speed and by no means at full speed against the direction of the race, navigating in the middle of the channel, this boat must display the yellow flag at all time. Failure to comply with this regulation will result in the assessment of a penalty of 15 minutes up to disqualification for the leg.
 - (b) If a boat is within sight of the staging area, it may proceed against the direction of the race only when another boat is not rightfully on the segment of the leg in the direction of the staging area, the returning boat must display the yellow flag at all time. Failure to comply with this regulation will result in the assessment of a penalty of 15 minutes up to disqualification for the leg.
 - (c) A boat may enter, or pass through, the staging area from ahead of the starting line only without obstruction or impeding a boat that is rightfully in the staging area and only when the ten (10) second flag is not raised. In the event of a mass start, a boat may enter, or pass through the staging area from ahead of the starting line only when there are no other boats rightfully in the staging area. Failure to comply with this rule may result in assessment of a penalty of 15 minutes up to disqualification for the leg.
13. A boat which is unable to start a leg including the last one (DNS) may continue to compete in subsequent legs. It shall be given a time for the unstarted leg equal to the Winner's time of his class for that leg, plus the time penalties according to the table in Rule 900.12.9 This rule can not be changed in the Advance Program.

14. If for any reason a boat will fully start on any previous minute, he will be assessed a penalty of 10 minutes per every minute that he advanced his start. In this case Rule 900.10.7 would also apply for the minute which the boat started in. For the time of the race leg, the jury will deduct the total amount of minutes which he advance his time and will add the corresponding time penalties.

900.11 - RACE IN PROGRESS RULES

1. Any boat that is overtaking another boat must do so in a safe and courteous manner. Maintaining when possible a safe distance between the boats.
2. Any boat that is being overtaken must give way and let the faster boat through no later than the point at which the overtaking boat is within the peripheral vision of the driver. Encumbering a faster boat is not permitted and doing so will result in the assessment of a penalty of 15 minutes up to disqualification from the race.
3. Any boat that willfully travels against the direction of the race after it has started, must do so according to Rule 900.10.12.
4. The loss of any equipment required in Rule 900.5 during a race must be reported to a finish line official for that leg or a penalty of 5 minutes will be assessed.
5. A race boat might or might not be permitted to refuel on a leg which is open to racing. This should be indicated in the Advance Program, if it is not indicated, the race boats will not be permitted to refuel.
6. The crew of the boat must remain in their seats at all times during the race. It is not allowed for any member of the crew of the boat to ride on the bow of the boat at any time during the race. Failure to abide by this rule will result in assessment of a penalty of 15 minutes.

900.12 - FINISHING RULES

For the purpose of the Rules 900.12, the winner: is the race boat which finishes a leg under its own power in the least amount of time.

1. A boat must cross the finish line under its own power. All the boats of a class which cross the finish line within the **allowed** time frame for the leg will receive their actual time. The boats of a class which cross the finish line, after it has been officially closed, shall be given a time for the leg equal to the **slowest boat** time of his class **which finished within the allowed time** for that leg, plus the time penalties according to the adjustment factors indicated in Rule 900.12.8. This will include the DNF boats Rule 900.12.4. This rule can not be changed in the Advance Program.
2. Once a boat has crossed the finish line, it may not re-enter an open leg, unless it is approved by race officials and it may only re-enter in order to get to the boat ramp. It will have to do it with precaution and displaying the yellow flag. By no means should cross the river if a racing boat is approaching the finish line. Failure to comply with this regulation will result in the assessment of a penalty of 15 minutes up to disqualification for the leg.
3. The leg's starting line and finish line for each class will be closed at the time indicated at the Driver's Meeting of that day, there will be a maximum of two hours allowed after the winner of a class arrives for them to be closed. If there are two or more legs which are run in a day, the closing times will be given at the previous Driver's Meeting(s). All the boats which cross the finish line after it has been officially closed will be given a time for that leg equal to the **slowest boat** time of his class **which finished within the allowed time** for that leg plus the time penalties according to the adjustment factors indicated in Rule 900.12.8, no matter how they got to the finish line by water or land. For the last leg if a boat has started the leg and was not able to finish within the time frame indicated in this rule it shall be given a time for the leg equal to the **slowest boat** time **of his class** plus the time penalties according to the adjustment factors indicated in Rule 900.12.8.
This rule cannot be changed in the Advance Program
4. A boat which is unable to finish a leg (DNF) may continue to compete in subsequent legs, this boat must have started the leg under its own power and must have run at least 2 km (1.2 mi). It shall be given a time for the unfinished leg equal to the **slowest boat** time of his class

which finished within the allowed time for that leg, plus the time penalties according to the adjustment factors in Rule 900.12.9. If a boat arrives to the finish line after it has been officially closed Rule 900.12.3 will apply. This rule can not be changed in the Advance Program.

5. Official results will be determined by total elapsed time plus any time penalties incurred. They must be posted at the site and before the next day driver's meeting.
6. Immediately after finishing a leg, the crew of the boat which has been picked for inspection should make his boat available to the Chief Inspector at the designated area and will be under the Inspectors custody until inspected. Failure to comply with this regulation will result in the disqualification for the leg.
7. If for any reason in one of the classes non of the boats finishes, the leg's finish line time for that class will be the time of the winner of the next smaller class plus **20** %. If there are no other classes to get this time from, the Finish Line Officials and the Chief Scorer will determine an Estimated Time, based on the distance of that particular leg at an average speed of that class, in this case for the boats which did not finish (DNF) this leg, they will have the Estimated Time plus the time penalties according to the adjustment factors in Rule 900.12.8, for the boats which did not start (DNS) this leg, they will have the Estimated Time plus the time penalties according to the adjustment factors in Rule 900.12.8. This rule can not be changed in the Advance Program.
8. The time which will be given to the boats which do not start (DNS) or to the boats which finish after the finish line is closed or the ones which start and not finish (DNF), will be the time of the **slowest boat** of his class for that leg **which finished within the allowed time**, plus the time penalties **calculated based on the following** :

ADJUSTMENT FACTORS

DNF DNS

1.10 1.30

PROCEDURE

To calculate the time **penalties** for a particular boat which did not start (DNS) or a boat which did not finish (DNF) will be the following: The time of the **slowest boat** of the class **which finished within the allowed time** for that particular leg must be multiplied by the corresponding factor.

900.13 - SUPPORT BOATS

1. The race committee shall provide sufficient boats to act as safety boats at critical locations along the race course. The safety boats shall be properly equipped to provide rescue and emergency first aid services. They will be subject to inspection by the Inspection Committee. All occupants in safety boats shall wear nationally approved type life jackets. The safety boat captain will be a Race Official. The safety boat captain and his crew must abide by the orders of the Safety Director.
2. The safety boats are not towing crafts, however, at the boat captain's discretion, he may provide a tow after the leg is closed to the racing boats, to the nearest boat ramp or either the starting or finishing lines.
3. The Race Committee shall provide a sweep boat which will have a Race Official on board. The sweep boat will be the last official boat to leave when the starting line is officially closed. The sweep boat captain will give directions to any race boats on the leg that are unable to continue under their own power.
4. The finish line will remain open until the sweep boat has crossed. Any race boat crossing the finish line after the sweep boat, and consequently after the leg has closed, will receive a time equal to the slowest time in its class plus a penalty of 10 minutes.
5. The sweep boat shall be clearly identifiable.
6. The support boats of any of the race boats must pass a safety inspection as per Rule 900.7.3.

900.14 - RACE OFFICIALS

Any Race Official may bring forth any infraction of these rules to the Race Director, the Race Official are:

- (a) Race Director
- (b) Safety Director
- (c) Safety Boat Captains
- (d) Chief Inspector
- (e) Chief Scorer
- (f) Starting Line Officials
- (g) Finish Line Officials
- (h) Ramp Officials

900.15 - INTERNATIONAL RACING CLASSES

1. Series: There should be a minimum of three boats registered per class, if there are less they will move up to the next available class.
 - A) Serie Inboard Boats, (I); classes SP2500, E, D, C, B, A, and Unlimited
 - B) Serie Outboard Boats (O); classes 2000 and 3000
 - C) Serie Inflatable Boats (P); classes 550V, 550, 850V and 850
 - D) Series Rigid Inflatable Boats (PR); classes 700, 750, 1000, 1500, 2000 and 3000
2. Inboard Engine Boat Classes:

Classes of Inboard Racing Boats: are determined solely on cubic capacity of the engine used and are distinguished as follows:

Hull: The hull design is free.

Length of the Hull: The minimum dimension are 3.96 m (13 ft).

Roll Bar: Any boat on classes E or above must have a well structured steel chrome molly **or aluminium** roll bar. Boats on class SP2500 must also have a roll bar. The minimum specifications for the chrome molly roll bar are : 1 1/2 "in diameter with a wall thickness of 0.065", **for the aluminium roll bar are : 3.16 cm (1 5/8 ") in diameter with a wall tickness of 3.80 mm (0.15") or a 5.0 cm (2") in diameter with a wall thickness of 3.80 mm (0.15") or a 5.0 cm (2") in diameter with a wall thickness of 3.0 mm (0.12")**. It is also recommended that the main "A" frame(s) be made of one piece and the structure of the roll bar be done with a set of triangles with front and back supports. It is also recommended that the elements of the roll bar be secured to the chines. If possible the seats and seatbelts should be attached to the roll bar cage structure. For the existing fiber glass boats it is recommended that a roll cage or a reinforced cockpit be put in. The roll bar **must** be at least 100 mm (4") away from any side of the helmet of the racing crew when seated **foam material can be used to cover this space**, as stipulated in Rule 509.05.

Seats: There should be a high back seat for each member of the racing crew, securely attached to the hull. The back of the seat should support the back of the helmet.

Seat Belts: The crew of any racing boat with a roll bar, must be strapped to the seat with four point seat belts system, at all time during the race, the straps should have a minimum width of 50.8 mm (2"). Two seat belts straps should run over the waist at the height of the hips and the other two straps should run over the shoulders. It is recommended that the wear of the straps should be checked periodically.

Engine Mounts: The engine on classes E and above must be attached to the hull, at least on four points, unless the set up of the jet and the engine allows it to only be attached in three points closed coupled. A safety device must be installed to the engine to avoid its forward movement in a case of a front collision.

Throttle: The throttle pedal should be attached to the hull and should be spring loaded, so it is capable of returning to the idle position.

Flotation: Its is recommended to put in the bow of the hull sufficient flotation material that would allow the recovery of the boat.

The engines on these class boats should be inboard, for each class there is a specific engine capacity range. All the boat must run with a propulsion of a jet pump and must not have any exposed propellers.

Classes	Capacity
SP 2500	Up to 2500 cc / Two cycle
E 3400	Up to 3400 cc
D 4200	3401 to 4200 cc
C 5100	4201 to 5100 cc
B 6000	5101 to 6000 cc
A 7700	6001 to 7700 cc
Unlimited	Above 7701 cc
Overall	Any of the above

Multiplication Factors:

- Forced Induction engines or those engines using combustion supporting additives (e.g. nitrous oxide, turbo charged, etc.), will be required to multiply their engine capacity by 1.8 to obtain their racing class.
- Rotary Engines will be required to multiply their engine capacity by 1.8 and if forced induction is utilized a further 1.4 to obtain their racing class.
- Diesel engines are not subject to any multiplication factors to obtain their racing class irrespective of whether forced induction is utilized.
- Turbine engines boats are allowed, any boat with one will run in the A / Unlimited class.

Exhaust: the use of an efficient manufacturer brand muffler is recommended. It will be compulsory that all boats have one at all times during practice and during the race, **if the local authorities require so, this must be indicated in the advance program.**

For "SP 2500 Sport Class" the only engines allowed to race are two stroke engines up to 2500 cc and they can not be modified.

Hull: Any shape and material, the minimum length shall be 3.96 mt (13 ft).

Machinery: The engine must be of a "Standard Production Line" the engine must be two strokes, V 6 cylinder, with a maximum of 240 HP,

Engine limitations:

- Maximum oversize piston diameter allowed for overhauled engines is 0.020"
- No modifications in the Cylinder Block Assembly; Reed Block; Cylinder Head Assembly; Crankshaft; Pistons; and/or Connecting Rods are allowed; All these engine replacement parts or parts contained herein must be of a standard production "off the shelf line items" available from the manufacturer.
- The whole exhaust system shall be the "standard" as included in the manufacturer's catalogue, no modifications are allowed.
- All boats must have a Muffler Assembly in the exhaust system.

Propulsion:

- The Jet Drive must be of a "Standard Production Line"
- All the Jet Drive replacement parts or parts contained herein must be standard production "off the shelf line items" available from the manufacturer.

Jet Pump limitations:

- No modifications in the transmission or in the housing of the jet pump are allowed.
- Impeller: shall be of a "Standard Production Line" off the shelf line item. No special production or impellers from other manufacturers are allowed.
- No modifications in the Nozzle and Rudder design, they should be kept as supplied by the manufacturer. The use of separators and/or wedges to modify the angle of the water output are allowed.
- The reverse system is NOT compulsory.

3. Outboard Engine Boats Classes

Classes of Outboard Racing Boats: are determined solely on cubic capacity of the engine used and are distinguished as follows:

Hull: The hull design for classes O 2000 and class O 3000 **is open, there is no restriction.**

Length of the Hull: The minimum dimension are 5.10 m (16 ft 9 in).

Racing Capsules: are not permitted

Roll Bar: Any aluminum boat must have a well structured steel chrome molly *or aluminium* roll bar. **The minimum specifications for the chrome molly roll bar are : 3.81 cm (1 ½") in diameter with a wall thickness of 1.65 mm (0.065"), for the aluminium roll bar are : 3.16 cm (1 5/8") in diameter with a wall thickness of 3.00 mm (0.12"). It is also recommended that the main "A" frame(s) be made of one piece and the structure of the roll bar be done with a set of triangles with front and back supports. It is also recommended that the elements of the roll bar be secured to the chines. If possible the seats and seatbelts should be attached to the roll bar cage structure.** For the existing fiber glass boats it is recommended that a roll cage or a reinforced cockpit be put in, as of 2008 it will be compulsory that all fiber glass boats have one. The roll bar **must** be at least 100 mm (4") away from any side of the helmet of the racing crew when seated **foam material can be used to cover this space**, as stipulated in Rule 509.05.

Seats: There should be a high back seat for each member of the racing crew, securely attached to the hull. The back of the seat should support the back of the helmet.

Seat Belts: The crew of any racing boat with a roll bar, must be strapped to the seat with four point seat belt system, at all time during the race, the straps should have a minimum width of 50.8 mm (2"). Two seat belts straps should run over the waist at the height of the hips and the other two straps should run over the shoulders. It is recommended that the wear of the straps should be checked periodically.

Engine Mounts: The engine must be attached to the transom of the hull, at least in four points.

Engine Cover: All engines must run with their cover on.

Transmission: The transmission used is free

Throttle: The throttle pedal should be attached to the hull and should be spring loaded, so it is capable of returning to the idle position.

Flotation: Its is recommended to put in the bow of the hull sufficient flotation material that would allow the recovery of the boat.

Propulsion: Only one propulsion devise is allowed and the total effort must be applied to the water

Machinery: The motor brand or make is open, and outboard motor is a mechanical assembly which can be removed from the boat as a single unit, complete with its transmission, and which does not transmit the power through the hull at any point. The motor thus taken off and placed ashore, must be capable of being started, fed by its fuel tank. Any mechanism intended to modify the angle of attachment and/or the height of the motor is authorized.

The mounting supports fixed to the boat, the control levers, the tachometer with its connections, the battery with its conductors and the fuel tank and lines do not form part of the power unit.

Classes	Outboard	Capacity	Fuel
O 2000	2000	1501 to 2050cc	Sport Fuel Rule 508.02
O 3000	3000	2051 to 3000cc	Racing Fuel Rule 508.03

4. Inflatable Boats Classes:

Classes of Outboard Inflatable Racing Boats: are determined solely on cubic capacity of the engine used and are distinguished as follows:

Hull:

- a) Boats can be inflated only with atmospheric air and the number of independent compartments must be such that the boat can float even if one half of the compartments is deflated.

- b) The boat must be deflectable, collapsible or foldable so that no dismantled part has a length greater than two thirds of the full length of the inflated boat, excepting the floor boards.
- c) The keel, inflatable or rigid, must extend along the whole boat and be properly fixed to the transom.
- d) The transom can be modified only for reinforcement purposes.
- e) The boats must conform with a model of the official catalogue of the manufacturer published during the last quarter of the previous year.
- f) Boats with a rigid underwater body made of fibreglass or any other type of rigid material are not allowed.
- g) Only original features provided for by the manufacturer are allowed under the water line.
- h) No other material can be inserted or attached between the floor and the bottom of the hull except the keel.
- i) Class 1,850 V: the only shape allowed is a V shape hull. Boats that tend to have the shape of a multihull are to be excluded, even if they are included in the official catalogue of the manufacturer. The transom must be made of rigid material to adequately support the motor.
- j) Length of the Hull: The minimum dimension are 3.50 m (11 ft 5 in).
- k) Racing Capsules: are not permitted.

Engine Mounts: The engine must be attached to the transom of the hull, at least in four points.

Engine Cover: All engines must run with their cover on.

Propulsion: Only one propulsion device is allowed and the total effort must be applied to the water.

Transmission: An efficient gear changing system giving forward, neutral and astern movement is compulsory. The gear control handle must be within easy hand reach of the driver.

Starter: An electric or manual starter must assure quick and easy start without external aids.

Machinery: The outboard motor is a mechanical assembly which can be removed from the boat as a single unit, complete with its transmission, and which does not transmit the power through the hull at any point. The motor thus taken off and placed ashore, must be capable of being started, fed by its fuel tank. Any mechanism intended to modify the angle of attachment and/or the height of the motor is authorized.

To be homologated as a sports motor, an outboard motor must be sold and advertised by an industrial firm as being manufactured in standard production series (with all identical dimensions, weights and material).

The mounting supports fixed to the boat, the control levers, the tachometer with its connections, the battery with its conductors and the fuel tank and lines do not form part of the power unit.

The motor must be able to function at reduced speed. When the motor is in the water, the cooling must be done by the water circulation pump.

Classes	Outboard	Capacity	Fuel
P 550	550	up to 550cc	Sports Fuel Rule 508.02
P 550 V	550 V	up to 550cc	Sports Fuel
P 850	850	up to 850cc	Sports Fuel
P 850 V	850 V	up to 850cc	Sports Fuel

The engines that comply with EPA regulations will be allowed to compete with a 30 % greater capacity in their corresponding class.

5. Rigid Inflatable Boats Classes

Classes of Outboard Rigid Inflatable Racing Boats: are determined solely on cubic capacity of the engine used, type of hull and are distinguished as follows:

Classes: as per UIM rule 566

Hull: as per U.I.M. rule 567 Except 567.01 and 567.03 Hull is monohull

Machinery: as per U.I.M. rule 568

The engines that comply with EPA regulations will be allowed to compete with a 30 % greater capacity in their corresponding class

901 - RULES AND CODE OF PRACTISE FOR JETSPRINT RACING

CONTENTS

1. General Rules	3
Course Design	3
Event Administration	4
Promoters Responsibilities	4
2. Boat and Safety Equipment	4
Safety Harness	4
Engine Mounts	4
Fuel Tanks and Fitting	5
Batteries	5
Fire Extinguishers	5
Steering	5
Engine Control	5
Personal Safety Equipment.....	6
3. Roll Cage Specifications	6
Roll Cage Construction Materials	6
Welding and Forming	6
Configuration.....	7
Method of Securing.....	7
Anchor Points.....	7
Bolting	7
Crew Protection	8
Drawing 1	9
Drawing 2.....	10

Drawing 3.....	11
4. International Jet Sprint Classes.....	12
Superboats.....	12
International Group A.....	12
5. Testing Procedures	13
Testing Apparatus	13
Method of Testing Group A Class	13
Workshop Capacity Testing.....	13
6. Sportsmanship and Competitor Code of Conduct	14
Penalties	15
Overview	15
Appeals	15
7. Event Rules.....	15
Definitions	15
Signals	16
Race Procedure.....	16

1. GENERAL RULES

- | | |
|----------|---|
| 1. BOATS | Any boat size, type and configuration, with a reciprocating engine, will be permitted, providing the boat is solely propelled by a water jet unit/s, carries two crew persons and complies with all safety requirements as specified under Boat and Safety Equipment rules including an approved Roll Cage. |
| 2. HULL | Hulls must be of metal construction up to the deck line; the deck line may not go down to the chine. All decks must be fitted in such a way as to add strength to the hull, and be permanently fixed. |

3. EXHAUST The use of an efficient manufacturer brand muffler is compulsory. All boats will be required to meet supplementary track regulations for noise. These limits shall be notified by the race organisers/promoter 30 days prior to the departure of any international crew. (Opportunity must be given for crew to meet noise restrictions prior to any race)
4. CONFIGURATION Driver and crew will sit side by side with a difference in seat placement fore or aft, of not more than 300mm to each other. Crew shall have a clear and unhindered escape route through the front of any roll cage.
5. All boats must carry two crewmembers (driver and navigator).
6. The timekeeper's word is final and no protests will be considered. The timekeeper's van/area is out of bounds to all competitors and their crew at all times except by direct invitation of the Sprint Controller. This also applies to the race control area.
- PENALTY: Unauthorised entry to race control area and timekeeper's van/area or contact with the timekeeper - may result in disqualification for the remainder of the day's racing.
7. Any boat may have a maximum of two crews. Each driver is to have his or her own navigator. Doubling up is prohibited (ie. no driver to navigate, navigator cannot drive, navigator can only navigate for one driver, driver can only compete in one class).
8. No driver or navigator may compete in more than one boat or class on race day. However, if a boat is rendered unable to continue racing, the sprint controller may permit the crew to continue racing in another boat, providing they can record a qualifying time in that replacement boat before the elimination rounds commence. Times previously recorded in the disabled boat will be disregarded. Only one boat change per crew per meeting is allowed.

- PENALTY: Boat substitution or change without approval - disqualification for the day or remaining rounds.
9. All items named in Boat and Safety Equipment shall be available for inspection at the time and place nominated for scrutineering.
- PENALTY: Race-day non-starter.
10. Scrutineering shall be at a time and place as nominated by the event organiser on the entry form and must be attended by all boats and crews unless prior arrangements are made with the organiser. The scrutineering area is declared an alcohol-free zone.
- PENALTY: Not attending scrutineering without prior approval - race-day non-starter.
- PENALTY: Consuming alcohol in any alcohol-free zone - race-day non-starter.
11. Entry forms submitted without payment or incomplete will be deemed invalid and disregarded. Late entries will only be accepted at the sole discretion of the promoter and may be subjected to a late entry fee and/or may be placed on a cancellation list. If a competitor wishes to withdraw an entry prior to the event, refund of the entry fee is at the discretion of the promoter. Entrants who are a "no-show" on race day are not entitled to a credit or a refund of their entry fee.
12. All drivers in order to compete, must be full financial members of their respective country's association or jet sprint authority, financial crew members from affiliated clubs and associations and licensed international crew members are deemed to meet this requirement.
13. Points accrued in any international series will be deemed to have been earned by a driver, not a particular boat or crew combination.
14. No driver shall compete with an injury or disability, which, in the opinion of the sprint controller could adversely affect his/her ability to safely and effectively control the boat. This includes the ability of either crewmember to safely and quickly exit the boat following an accident. Medical clearance in writing may be required before a driver or navigator is allowed to race.

COURSE DESIGN

International Events will only take place on suitable tracks homologated by the IJF, or its duly authorised agents. For more information contact the: International Jet Sprint Federation PO Box 1456 Taupo 2730 New Zealand Email-emoore@xtra.co.nz

EVENT ADMINISTRATION

1. A Sprint Controller will be appointed to control each event.
2. The Sprint Controller is the final arbiter for any disputes other than official protests on the day.
3. An approved host country authority member who has had at least two years experience in Jet Sprinting shall carry out Scrutineering. Any queries, which cannot be satisfactorily resolved by the scrutineers, shall be referred to the sprint controller for a decision the Sprint Controller is the final arbiter.
4. The IJF reserves the right to alter any of the above rules so as to accommodate any unusual or unforeseen circumstance or errors that may arise from time to time or country to country

PROMOTORS RESPONSIBILITIES

1. Promoters of all events must provide adequate first aid equipment, for any likely emergency, and ensure the attendance of qualified first aid personnel and an ambulance available at trackside.
2. Promoters of all events must provide adequate fire extinguishing equipment for any likely emergency. (Race gas and Methanol). It is preferable to engage the services of a trained fire crew.

3. Promoters of all events must engage the services of at least 20 able bodied people to act as boat pushers. Although the primary requirement is to assist with refloating of boats, which have become grounded, an essential aspect is an ability to quickly react and assist with any craft in difficulties that may endanger the crew. (i.e. a roll-over) The Pushers must be given a safety briefing prior to commencement of the event, so that they are conversant with the requirements regarding the safety of a crew in the event of a roll-over under water and that they are aware all other safety requirements concerning their own safety in the handling of boats.

2. BOAT AND SAFETY EQUIPMENT

SAFETY HARNESS

1. Must be fitted for both crew and be securely attached to the roll cage or the seat base bearers. They must be a motor sport type approved and a minimum of 75mm web, a 5 attachment point harness is the minimum, a 6 point is recommended both shall have a lever action quick release buckle and be within their use by date as set by the manufacturer. (See roll cage specs) Push lock or twist action buckles are not permitted.
2. The mounting point for the shoulder straps behind each crew member must be between a line horizontal to the shoulders, and a line drawn downward from the shoulders at an angle of 25 degrees to the horizontal. If the shoulder straps join prior to a single common mounting point then that junction shall be at least 150mm behind the crew members neck.
3. weakened due to the actions of chemicals abrasion or sunlight etc. Safety belt harness hardware must be replaced if it is bent, deformed or rusted.
4. The lap and crotch straps may not pass over the sides of the seats but through the seats in order to wrap and hold the pelvic region over the greatest possible surface. Care shall be taken that the webbing of the harness is protected against chaffing in any area.

5. Shoulder straps must wrap around the horizontal cross bar of the roll cage as the only means of attachment.
6. All Drivers and Navigators must be scrutineered with their nominated boat so their safety equipment can be checked for correct size.
7. Motor sport type approved arm restraints must be worn on the outside wrist of each crew member and shall be of a length which will prevent the arm from protruding from the boat in the event of a roll over. They must be attached to the safety harness in such a way as to release freely when the buckle is released.
8. Head restraints for both driver and navigator are compulsory, these may be either motor sports approved mounted from the shoulders to the helmet or the fixed type from to the seat back head rest protruding out each side of the helmet in a line drawn forward past half the forward length of the helmet when the head is rested to the back of the seat in the sitting position. Head restraints must have the ability to absorb the side to side impact of the head under racing conditions without being left permanently bent out of shape after normal racing.

ENGINE MOUNTS

1. Engines are to be solid mounted to the main engine bearers. Where an engine mount is built to create a frame there shall be a minimum of four, 3/8 in. bolts or metric equivalent to secure that frame to the main bearers of the boat. Where engine mounts create four separate attachment points there shall be a minimum of eight, 3/8 in. or metric equivalent.
2. Flexible mounts will only be permitted if they have security through bolting and it can be demonstrated to the scrutineers' satisfaction that the through bolt is designed to restrain the engine should the flexible portion fail.

FUEL TANKS AND FITTING

1. Fuel tanks must be securely mounted and be fitted with a non spill sealing cap. The tank must not be mounted in such a way as to be a stressed or a load bearing part of the boat structure.

2. Adequate breathers are to be fitted to the fuel tank, the breather tube must include a non return valve and be vented to the outside of the boat.
3. A fuel filler must be fitted in such a manner that no fuel can spill into the hull during refuelling.
4. All fuel and vent lines must be resistant to the type of fuel used. All fuel lines must be attached with proper fittings no hose clips or clamping of fuel lines is permitted. (With the exception of the fuel filler to the scrutineers satisfaction)
5. A fuel shut off tap or control must be fitted and identified by its own red triangle (75mm sides) and must be located between the seats or on the dash and able to be operated by either crew when harnessed in their seats.

BATTERIES

1. The battery should be of a non-spill, (ie. manifold-vented or gelled type) and firmly secured to the hull or bearers.
2. An operating battery isolating kill switch must be installed and located between the seats within easy reach of both crew whilst harnessed in their seats. Metal constructed boats should have the isolating switch to the earth terminal.

FIRE EXTINGUISHERS

1. Approved fire extinguishers must be carried on the front of boat trailers. They must be easily accessible.
2. Approved Types: The extinguisher fitted to any boat must be of a type designed to extinguish the fuel type used in that boat.

All types must carry standard approval label and a certificate showing that it has been serviced in the last 12 months. Aerosol types not permitted.

STEERING

1. All shackles and turnbuckles in the steering system must be lock-wired. (Nylon TY wraps are acceptable)

2. Chain guards/guides must be fitted to each side of the steering chain sprocket. All open pulleys must be fitted with keepers. Where steering is a lever system any shackle attaching steering cables shall be lock wired. Especially designed taper lock cable joiners may be accepted at the scrutineers' discretion. All steering cables must be from a braided type wire rope, with a minimum 750 kg breaking strain.
3. Jet unit steering shafts where fitted shall have Nylok type nuts, the thread of any bolt must protrude through the nylon locking device or have been locked by fitting two standard nuts.
4. An operational reverse is mandatory for all boats.

ENGINE CONTROL

1. Two throttle return springs, either of which is capable of closing the throttles, must be fitted in addition to any internal carburettor throttle shaft springs. Where fuel injection is fitted there will be at least one spring on the accelerator pedal in addition to the factory fitted springs on the throttle shafts. Where this is not possible the spring will be fitted to the main operational lever of the fuel injection where the throttle cable is attached. At all times for any boat the throttle must be able to return to the idle position unaided.
2. Any other items that in the opinion of the scrutineer are unsafe must be rectified to the scrutineers' satisfaction.

PERSONAL SAFETY EQUIPMENT

1. Safety equipment must be properly and securely fitted to the crew, prior to the boat lining up at the start line and all must be in place when the boat crosses the finish line. No other items of clothing shall be worn over the fire retardant suit.
2. A bow-towing eye with at least a ten mm hole must be fitted with a d-shackle to suit, to aid the rescue crew or towboat to attach a safety line.

3. The driver shall be responsible for checking that his or her crew is wearing the required safety equipment and that it is correctly adjusted, before proceeding onto the start line. The starter will visually check safety equipment prior to allowing any boat to cross the start line, but will not be responsible for any item not being in place during competition.

PENALTY: Incorrect fitting or missing safety equipment during run – DNF

4. All crew in boats must wear Motor sport approved flame retardant balaclavas and hand protection. Balaclavas with openings from eyebrows to above the chin are acceptable. Balaclavas must not be of the peephole type, the mouth and nose must be easily cleared.
5. All competitors whether they are competing or practicing must wear a correct fitting approved helmet; motor sports type neck brace, arm restraint, enclosed footwear and fire retardant suit. Cotton workman overalls will not be accepted.
6. Any brand of crash helmet is allowed provided they meet the standard specifications applied by the Jetsprint authority in the Country of origin of the boat and crew concerned. Approved Internationally manufactured helmets may be eligible for competition use, consult an IJF representative for approval. Open face types only. All helmets must be in excellent condition with no frayed chinstraps or rusted anchor points and must correctly fit the person who wears them. Full-face or types with removable face pieces are not acceptable.
7. All boats must be fitted with a working bilge pump.

3. ROLL CAGE SPECIFICATIONS

1. A roll cage, which meets these minimum specifications, must be fitted to all boats.
2. Boats not complying with these standards will not be permitted to race.

3. The intention of these specifications is to provide the best possible protection to drivers and navigators, taking into consideration the accidents, which have occurred within the sport, and best practices in other motor sports. No guarantee is implied or stated, nor is any responsibility taken, regarding the degree of protection or safety afforded by any roll cage constructed to these specifications. Owners are encouraged to seek the advice of a structural engineer qualified in roll cage design.
4. All jet sprint boats are to have roll cages constructed so that all parts of the crew's bodies above the deck line are contained within the roll cage structure. At the same time, the roll cage should provide minimum restriction to the driver's vision to the sides or front and must allow quick and easy access and exit, especially in the event of an inverted accident. While different designs of roll cages will be permitted, each design must satisfy the requirements stated above and be constructed to the following minimum specifications.

ROLL CAGE CONSTRUCTION MATERIALS

1. Only round tubing is deemed acceptable.
2. Mild steel tubing minimum diameter 41.2mm-1 5/8"; DOM, 1020/26, mechanical (Drawn over mandrel, round carbon steel tube) 3.0mm- .120 wall thickness minimum.
3. Dimensions for mild steel roll cage as per drawing three.
4. Chrome molly tube; minimum diameter 38.1 mm, wall thickness 2.1 mm.

WELDING & FORMING

1. All joints must be fully welded by a competent welder with all welds being of good external appearance and remain un-ground using the TIG or MIG process with the 4130 filler wire, for chrome Molly.
2. Joints should be preheated and welded in 90-degree increments to avoid brittleness. (Chrome Molly)
3. Tube must be contoured and shaped for a close fit prior to welding.

4. Tubes cannot be flattened in order to make a joint.
5. All bracing bars should be of straight tube between attachment points.

CONFIGURATION

1. All bracing and the rear A frame must be straight between attachment points. (Drawing one)
2. The main A frame roll cage structure and brace bars must be of one-piece continuous tubing. No welds permitted other than at attachment points and capping plates.
3. The top corners of the overhead framework must be formed with one 90 degree formed on a bender suitable for bending the chrome molly size used.
4. The two A frames must be spaced apart a minimum of 100 mm between centres.
5. Capping plate (3 mm) must be welded to each corner of the A frame covering the entire bend. (May be mild steel)
6. A minimum of one (3 mm) plate or tube must be welded in between the capped A frame corners between the top bars.
7. The mounting points on the cage for the shoulder straps behind each crew member must be between a line horizontal to the shoulders and a line drawn downward from the shoulders at an angle on 25 degrees to the horizontal.
8. The two A frames must have a brace on the side so as to form an A section on the side of the cage and should where possible also be attached to the side panel (gunwale) as well as the chine.
9. Helmet Clearance; 5 or 6 point harness, a minimum clearance of 100 mm from the top of the helmet to the underside of the cage top bar must be maintained for all crew.
10. An X styled brace going from the upper outer A frame to either:

The back cross bar and then down to the engine bearers or outer chine area. (The bottom part of the X brace can be removable in this configuration provided suitable hardware is used)

Go directly to the engine bearers or chine and joined where they intersect. (If the lower part of the X brace goes to the chine it must have suitable load distributing plates on attachment points)

11. Seats must mount to the one piece cross bars shown in drawing three and be attached at all manufacturer located mounting points or a minimum 4 points at the base and 1 at the back above the shoulder line of any crew.
12. All attachment points to the seats must be a minimum of 3 mm mild steel and able to support the entire weight of the crew throughout any crash without distortion to the mount between the seats and roll cage crossbars or cross members.

METHOD OF SECURING

1. Attachment plates or load-spreading flanges must be welded to the tube ends to secure the cage to the boat and must be at least 5 mm minimum thickness.
2. For rectangle attaching plates:
Minimum width of attaching plate = tube diameter.
Minimum length of attaching plate = tube diameter x 2.
3. For circular attaching plates:
Minimum diameter of round flanges should be tube diameter x 2.
The roll cage may be bolted or welded to the boat as defined below.

ANCHOR POINTS

1. The primary elements of the roll cage must be secured to the main engine bearers and the chine.

2. In the absence of chine bearers in an alloy boat, the cage should be attached in the chine area of the bottom skin with load-spreading flanges as above.
3. In addition to the above, the main roll bar structure may be attached to the fore or side deck, provided that a brace bar of the same type and size material as the roll bar continues the load path through to the bottom of the boat. Provided the primary elements of the roll cage structure attach to the boat bottom as stated above, then braces may be attached to the roll cage in order to strengthen the boat sides or deck structure.

BOLTING

1. Through bolting with back-up washers.
2. Minimum of two bolts per attachment point.
3. Minimum bolt diameter 3/8in for two bolts, four bolts - 5/16, six bolts - ? etc or metric equivalents

CREW PROTECTION

1. The driver and navigator must be able to exit an inverted boat through the front area of the roll cage with no frame members in such a position as to impede their exit or rescue.
2. The frame of the cage must protect the crew from any frontal or inverted impact to their head and torso and must be able to restrain the engine from moving forward far enough to cause injury by having suitable cross-members in place.
3. No cage should project more than 7in/17.8cm above the helmet of the tallest crewmember.
4. A minimum clearance from the top of the crews' helmet to the underside of the roll bar will be 100 mm (4 inches) for a five or six-point harness

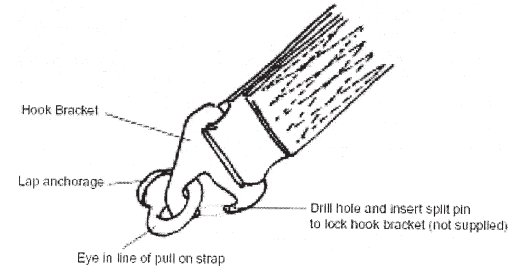
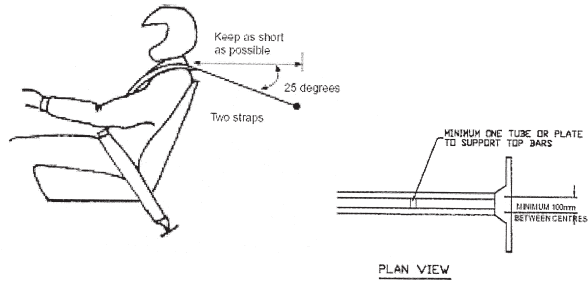

A split pin must lock the seat belt hook to the lap anchorage.

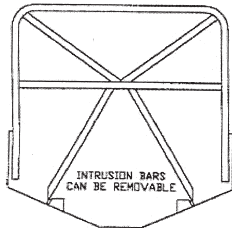

BACK VIEW

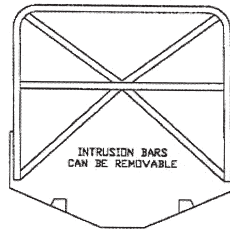

BACK VIEW

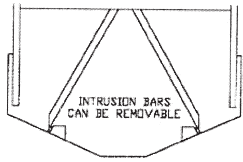

BACK VIEW

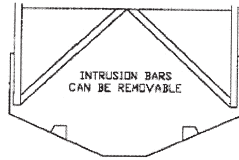

BACK VIEW

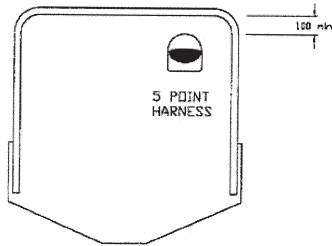

HELMET CLEARANCE

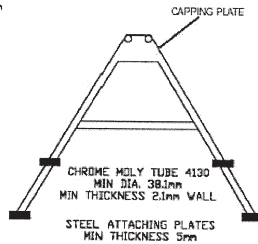

SIDE VIEW

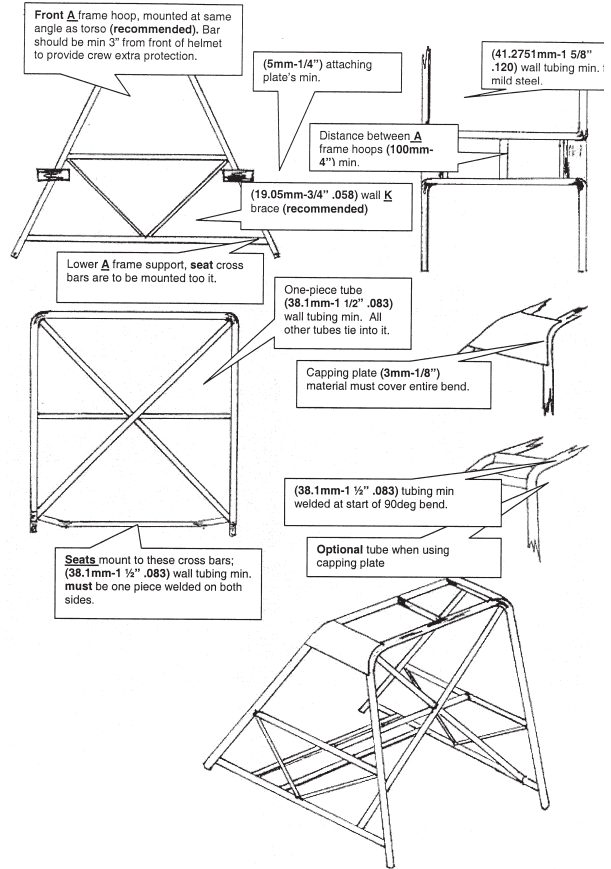

4. INTERNATIONAL JET SPRINT CLASSES

SUPERBOATS

1. All naturally aspirated engines must be a minimum of 6.5 litres displacement, and if any naturally aspirated engine is under seven litres displacement, it must be equipped with alloy heads, use methanol fuel and have multi carburettors or fuel injected induction system.
2. Forced induction engines must be a minimum of 3.8 litres displacement.
3. Under special circumstances it may be possible by request, to have boats that do not comply to the above requirements, to be awarded Super boat status.
4. If Superboat status is granted, the boat will only be eligible to compete in the Superboat class for that season then would need to re-apply.
5. The use of fuels other than petrol is permitted. The only Methanol (alcohol) fuel is Mobil No 5 and equivalent Oil Company brand Fuels. The use of any nitrous oxide or nitro Methane type fuels is prohibited.
6. The minimum age for Super class competitors shall be 18 years of age for drivers and 16 years of age for navigators. Proof of age will be required on demand.

INTERNATIONAL GROUP A

1. The minimum age for Group A competitors shall be 16 years of age for drivers and 16 years of age for navigators. Proof of age will be required on demand.

JET UNIT

Single unit only, direct drive only (no gearboxes) otherwise no restriction.

ENGINE CONFIGURATION

2 valves per cylinder, push rod operated, maximum of 8 cylinders, single engine and internal combustion only.

OILING SYSTEM

Wet sump only.

CONRODS / CRANK

No Titanium or alloy.

ENGINE BLOCK

Cast iron only.

CYLINDER HEADS

Cast iron only exceeding 365 cu inches. Engines not exceeding 365 cu inches maximum swept capacity may use aluminium cylinder heads conforming with these rules only.

Cylinder Heads. Chevrolet. Valve angle 23 degrees to engine block face, OEM production position only. All Port and bolt locations OEM production position only, intake port size template FELPRO gasket-part No 1206.

Cylinder Heads. Ford. Valve angle 10 degrees to engine block face, OEM production position only Part. Number. M-6049-N351. Template Intake port size FELPRO gasket-part No. 1262. All port and bolt locations OEM production positions only.

All other engines within these regulations but outside the specified cylinder head configurations must apply for full homologation or run the NASCAR approved Carburettor. Holey Part Number 0-80507. Barry Grant Part Number. 30600300T. 1 and 1/16th inch Venturi and 1 and 7/16th inch Throttle Bore.

Camshaft. Single camshaft only.

ENGINE CAPACITY

412 cu inch (6,752 cc) maximum swept capacity, minimum 345 cu inch capacity.

INDUCTION SYSTEM

Single 4 barrel carburettor, with a maximum 4 venturis, none of the throttle body bores or the butterflies on the carburettor may exceed 1-11/16 inch in diameter. No fuel injection or electronic fuel-metering device permitted. No additives may be discharged into the intake tract.

CONTROL FUEL

Will be provided at all international meetings by the promoter and paid for by competitors of the class involved.

FUEL

Will be 100 octane Race gas. The control fuel will be dispensed either from a central point to which each boat must come, or by smaller containers refilled from the main source. The scrutineer will be in charge of and oversee all refuelling operations. Fuel tanks are not required to be drained prior to the addition of control fuel provided that a tank has maximum capacity of not more than 30 litres.

5. TESTING PROCEDURES

1. At any meeting, any boat's engine capacity may be tested, at random, without notice. The decision to conduct testing shall be made by the committee prior to the commencement of that meeting. Other boats may be tested, time permitting, as the chief scrutineer or his appointed deputy sees fit, but only after they have been eliminated for that day.
2. The crew of any boat found to have an illegal engine capacity will be disqualified and will lose all points and placing's gained since that boat's last capacity test.
3. The crew holding lower placing's will move up in the finishing order one or more positions as required. Where boats are disqualified and the finish order reshuffled, the top three must still be tested prior to presentation.
4. Testing will be conducted by the chief scrutineer or appointed deputy and in the continual presence of the boat owner or designated representative.
5. Refusal to allow an engine to be tested will be taken as evidence of over-capacity and the stated penalty applied immediately.
6. The results of the capacity testing as detailed will be final and no protest will be entered into provided the equipment falls within its manufacturer set tolerances.

Note: All testing methods must be approved.

TESTING APPARATUS

1. A measuring flask of 1.000cc's certified capacity (known brand name) and have sufficient height so as to have distinct and well-separated graduations.
2. A length of flexible hose 300mm to 500mm long with one end attached to the bottom of the measuring flask, the other end able to accept either a large or small spark plug hole fitting, drilled to allow fluid to pass.
3. One litre of testing oil, to be a recognised upper-cylinder lubricant.

METHOD OF TESTING GROUP A CLASS

1. Engine must have: - All spark plugs removed, one rocker cover removed, both rockers on one cylinder backed off, so that the valves remain closed at all times.
2. Bring the piston to approximately TDC on the cylinder being tested.
3. Screw the measuring flask connecting hose into the spark plug hole.
4. Fill the measuring flask with testing oil and raise the flask above the cylinder, keeping the connecting hose as vertical as possible.
5. Turn the engine over slowly by hand until no more air bubbles are expelled.
6. Turn the engine over slowly by hand three times, recording the maximum and minimum level readings each times. (At all times, the oil level must remain within the graduation range of the flask). The oil level may be topped up in between reading sets if necessary and the process should be repeated until two readings are within 8cc of each other.
7. Taking the difference between the two readings and multiplying by the number of cylinders will yield the total engine displacement. For Group A boats, this may not be more than 6752 cc or 412 Cubic inches.
8. Maximum allowable capacity for one cylinder is $844\text{cc} + 1\% = 852\text{cc}$ for Group A boats. (8-cylinder engine)

9. The engine will be classed over-capacity if: Measuring flask reading is more than 852cc (for Group A) per cylinder, the engine cannot be turned over one full revolution.
10. Oil leakage from the cylinder is such that no two readings are within 8cc (in this case, another cylinder must be tested. The number of cylinders to be tested is at the scrutineers' discretion).
11. Note: Competitors suffering a total engine failure, such that the engine cannot be tested will be treated as having an under-capacity engine for the day.
12. The method of testing Superboat engine capacities, will generally be those as indicated above for Group A class, however capacities should be substituted so as to comply with the class capacity rules.

WORKSHOP CAPACITY TESTING

1. Only one head of a "V" configuration engine need be removed to enable access to the cylinder bore for the purpose of accurately measuring the bore and stroke of that engine. The resultant calculated swept volume shall not exceed 412 Ci. or 6752 c.c.'s for Group A.
2. There shall be no tolerance permitted when the capacity is measured in this manner.

6. SPORTSMANSHIP AND COMPETITOR CODE OF CONDUCT

1. There is a total commitment to promote and foster good sportsmanship within the jet sprinting movement. This is to assist in the creation of a strong, positive public image of a group of competitors with a professional attitude, providing exciting, spectacular entertainment.
2. All competitors, their crew and race officials are expected to understand and display, in public, all those qualities which define good sportsmanship.

3. Obvious public displays of bad sportsmanship by any member will be considered a breach of the code of conduct and subject to disciplinary action.
4. The code of conduct requires not only a public display of good sportsmanship, but compliance with the rules of racing and the contractual obligations of the individual competitors and their teams via the signed entry forms carrying conditions relating to behaviour and general codes of practise as outlined in these rules.
5. During a pit walk by members of the public at least one member of the boat crew shall remain with the boat to foster good relations and public image by interacting with spectators as they view the boats in the pit area.
6. All personnel involved with an event, competitors, their crews and officials are required to function within the code of conduct.
7. The pits are a controlled-access area and an alcohol-free and smoking-free zone. Entry is confined to competitors who are entered on the day, pit crew, officials and those holding pit passes. Non-competing, financial members may not use their licence as a pit-pass, and not as a free event entry pass. Children must be under the control of a responsible adult at all times.

PENALTY: Abuse of licence. Cancellation of licence for six months.

PENALTY: Smoking or drinking alcohol in the pits - exclusion from the pits for the remainder of the meeting. Competitors or officials will be suspended for one meeting. Repeat offence - 12 months suspension.

8. There is a total ban on the consumption of alcohol and any other intoxicating substances by all boat crews and all event officials, including safety crews, for 8 hours prior to the commencement of briefing and for the duration of the meeting, or until they have completed their racing activities for the day. No crewmember, or support crewmember may consume alcohol whilst wearing racing apparel. Crews are required to have a zero blood alcohol content prior to racing and to comply with insurance conditions. Breathalyser testing of crews may occur, prior to commencement of racing. This ban applies to prescribed drugs and other performance-affecting substances. No alcohol may be consumed in the pit area by any person during racing.
9. A declared alcohol free zone refers only to the consumption of alcohol and/or prescribed drugs by any person in that area, and does not presume to enforce civil law relating to the possession or presence of it in a vehicle which may be parked in that area. However, any member who willingly breaks a civil law concerning prescribed substances in a manner which brings the sport into disrepute, may be deemed to be in a breach of the code of practice and can be penalised as provided for in the general rules of IJF.

PENALTY: Consumption of alcohol during meeting: minimum one meeting ban.

PENALTY: Competitors registering any blood/alcohol content prior to racing: - start denied until breathalyser registers zero.

10. Smoking is prohibited in the pit area. Any person smoking in the pit area may cause the disqualification of their associated boat. A crew smoking area may be established adjacent to the pit area at each track.

PENALTY: Disqualification for remainder of the days racing.

11. No competitor may abuse a race official. Any competitor, who has a dispute with any official on race day, must present the details of the problem to a class representative who may consult with the Sprint Controller for resolution. Likewise, any competitor who has any complaint concerning the running of the race day must firstly present the details in person to a crew committee member. If no committee members are present, then the complaint may be presented to a race official.
12. No official may abuse a competitor. If there is a perceived problem with the behaviour of a competitor, the matter must be brought to the attention of the sprint controller. (The disputes committee will be comprised of the sprint controller, host country representative, and IJF representative)
- PENALTY: Abuse of official: disqualification for remainder of the day. Further penalty may be applied.
13. No competitor or crew shall be involved in any instance of dangerous behaviour, or conduct which deliberately causes or could cause disruption to a race meeting, nor may they take any action, verbal or otherwise which may be deemed to bring the sport into disrepute.
- PENALTY: minimum: disqualification for the day - further disqualification possible at the discretion of the U.I.M.

PENALTIES

1. For any offence occurring on race day or as a result of scrutineering, the maximum penalty, which can be imposed by the Sprint Controller, shall be disqualification for that day. Additional penalties can only be imposed by the disputes committee following race day and after consultation with all parties concerned with the incident.
2. A penalty for a breach of the rules may, at the discretion of the sprint controller, be in the form of a suspended penalty and shall remain current for a period of up to one year from the time of the offence. Any further breach of the rules within that time shall cause the suspended penalty to be immediately applied.

3. Suspension penalties for one or more meetings shall apply from the next listed meeting and if more than one, shall be consecutive.

OVERVIEW

1. The Sprint Controller shall have certain discretionary powers to deal with disputes and may make a ruling concerning a dispute.
2. The ruling will be given after due and careful consideration of the issues involved and will be final. It will not be open to further discussion on the day.
3. Any ruling, which affects the results of the day, may not be challenged on that day, but can be subject to appeal by affected competitors as per the appeals rule.
4. The disputes committee will formally advise affected persons that they have been reported for a breach of the rules or the code of conduct.

APPEALS

1. The disputes committee will be comprised of the Sprint Controller, host country representative and the Commissioner.
2. Whenever possible and practical, the Sprint Controller will consult with the disputes committee when considering disciplinary action.
3. The sprint controller, may request a competitor to attend a meeting of the disputes committee, either during the event or at some other suitable time, to provide good reason why they should not have disciplinary action taken against them for a breach of the rules or code of conduct, which in the opinion of the sprint controller, could bring the sport into disrepute.
4. Failure to attend such a meeting will result in the immediate imposition of the appropriate penalty without right of appeal.
5. Notwithstanding the listed penalties, it is policy to apply penalties progressively. A warning may be issued followed by the prescribed penalty for a repeat offence.

6. A non-time related protest must be submitted in writing by a competing crewmember and accompanied by a US \$100.00 protest fee (or equivalent). It may be lodged immediately or at latest, within 15 minutes of the occurrence and handed to a class representative and the sprint controller. The disputes committee will hear the protest as soon as possible and if upheld, the fee will be refunded.
7. Any competitor who protests the eligibility of the engine of a competitor, shall be liable for all costs associated with the testing of that engine, including parts and labour if necessary, should it be proved to be legal. If the protest is upheld, the owner shall bear all associated costs.
8. Members seeking information on rule interpretations must first consult with a class representative, but if none are available, then the sprint controller may be approached.
9. Any member subjected to disciplinary action may lodge a formal appeal within 7 days of a penalty being imposed. Refer to the U.I.M. appeal rules.

7. EVENT RULES

DEFINITIONS

Commissioner – The U.I.M. appointed representative.

Class representative – The selected person to represent the drivers of a particular class on race day

Disputes committee – The sprint controller, a host country representative and the commissioner.

DNS - did not start.

DNF - did not finish.

Qualifying – The rounds in which a competitor can take their best time to secure a place in the elimination.

Elimination – Meaning the rounds where a competitor has only one opportunity to progress forward with their fastest previous time. i.e. qualified time to fastest 16, fastest 8, fastest 4, fastest 2.

Run – The completion of the prescribed track by following the course directions as handed out on an official map of the race course at a given event.

Class representative – The selected person to represent the drivers of a particular class on race day

PROCEDURE FOR CALCULATING POINTS IN A CHAMPIONSHIP

Points shall be awarded depending on the placing achieved in a race as follows :

First place : 40 points

Second place : 39 points

Third place : 38 points

Etc ..

Down to Fortieth place (40th) : 1 points

Should there be more than 40 crews competing in any one class this system would need to start with the first place being awarded 50 points decreasing to 1 point for 50th.

If the event of a tie for 1st or 2nd position at the completion of the series a run off shall be held immediately.

SIGNALS

- Flags will normally initiate starts, however light signals may be used. A boat may not start until the starter gives the appropriate signal. This is a safety requirement and the driver and navigator must be satisfied that the previous boat is back in the pit area and clear of the spinout pool, the towboat is back in the pit pool and all safety crew groups are in position. (Note that the timing is triggered by the boat at a point some distance after the start lights and therefore does not commence with the display of the green light).

- Each group of safety crew may have a red and green flag. In this instance, unless the track is clear of boats, crew or unplanned obstacles, a red flag will be displayed and a start is not permitted. A green flag signifies that the particular section of track is clear and the safety group is in position. Where it can be demonstrated that the event is efficiently controlled by two-way radios the requirement for the flag system may be waved in consultation with the sprint controller.

- Signals - Due to the noisy environment, signals will be utilised by the starter and the safety crew. The starter has control of the start lights or flags which will be:

RED You may not start or pass this point under any circumstances.

AMBER A start is imminent, you should be idling toward the start line and are under the control of the starter.

GREEN You are cleared to start. The two and ten minute time limits do not apply for a normal start. (Time does not start until the timing beam is broken)

BLACK You are disqualified for that run.

PENALTY: For jumping the lights or start signal or being out of position - 10 seconds added to the time for that run. If a dangerous situation is caused, a disqualification will occur.

RACE PROCEEDURE

- Each race event will commence with a roll call and crew briefing, the time of which will be advised to all drivers entered. All competitors, both drivers and navigators, must attend the pre-race briefing, the track walk safety inspection and sign any liability waiver form before racing. Competitors must be in attendance at roll call and/or briefing. Competitors who suffer an incident outside their control, and who in the opinion of the sprint controller were making every reasonable effort to attend the event on time, may be allowed to compete. In this case the competitors will be given a full and separate briefing prior to

competing. As part of the briefing all crewmembers must be invited to raise any concerns over course safety.

PENALTY: Late to roll call on race day - disqualification for the day.

2. Event, track or boat sponsors who compete as guest navigators must sign the waiver form prior to their run and wear all specified safety equipment.
3. While racing is in progress, each boat is to have one crewmember at the boat or close by in the pit area, in case of a change to the running order.
4. There is a speed limit of 5kph or minimum idle in the pit pool and on entrance thereto, where a spin-out pool is provided each finishing boat must use this facility to reduce speed to idle, prior to entering the channel approaching the pits. If there is no spinout pool, an alternate procedure will be advised either at the crew briefing, or in the track supplementary regulations.
PENALTY: Speeding in pits and/or creating a wash hazard or other danger - disqualification for the remainder of the race day.
5. No person other than official, licensed entrants and the towboat driver shall drive or compete on the track on race day without the consent of the sprint controller.
PENALTY: Disqualification for a period of up to one year for the crew involved.
6. Boats will start from idle power in forward thrust and may not accelerate until given the start signal which will be when they are wholly within the start gate as indicated by the starter. Cones, on the bank adjacent to the start channel, will normally mark the start gate. A third cone will indicate the 10m-aborted start limit.
7. If upon initial acceleration a problem occurs with the engine or jet unit, the driver may request one re-start immediately by reducing power and raising an arm. The boat must return to the pit-pool via the shortest possible route to the spinout pool at reduced speed before rectifying the problem, e.g. weed in intake. Use of this rule to

obtain an advantage will result in a DNF (Note that time limits may be applied to restart).

8. Only one re-start will be permitted per boat per round and the abort signal must be made within 10m of the start. (A marker will be positioned to mark this limit). This allowance is not meant to compensate for a poor start and will be at the discretion of the sprint controller.
PENALTY: Aborting the run more than 10m from the start - DNF (see also event rule 14).
9. If a boat becomes grounded during a run, the crew may attempt to re-float their boat, only by manipulation of the engine and jet unit. They may not receive any outside assistance and no item of safety equipment, including safety harness, may be removed during this attempt. Timing will continue until the crew is successful or the driver turns off the engine and calls for assistance by raising an arm. If the attempt is successful, they may continue racing and can record a time. (There will be a 20 second time limit on re-floating your boat in this manner).
PENALTY: For removal of safety equipment or receiving outside assistance - DNF.
10. When a boat is grounded and the assistance of the safety crew is required, the following procedure must be adhered to: The driver must shut off the engine and raise one arm to signify that assistance is required.
11. Assist the safety crew to re-float the boat by getting out if required by safety crew. Once back in the water, ensure that you have permission from the safety crew before you restart your engine and move back to the pits. Once re-started, drive back to the pit pool by the shortest route to the finish line at a speed only fast enough to prevent further grounding in shallow channels. Boats may not return to the pit pool via the start line channel unless indicated by the starter.
PENALTY: failure to comply DNF for next round.

12. If the tow-craft is called for, but then not required, the boat may not proceed to the pits until the tow-craft has been turned around and returned to the pit pool. If a dangerous incident is created a penalty will be imposed. Once re-started, a crew may not continue to drive the rest of the course as practice.

PENALTY: DNF for the next round.

13. Whilst racing, a boat may not pass through the finish line at any time other than at the conclusion of its run.

PENALTY: DNF

14. During a run, if a crew notice any dangerous circumstance, distraction or an unusual object in the track, eg. a floating tyre, they can abort their run by slowing down, raising an arm and immediately returning to the finish via the quickest and safest route. If the safety crew can verify that there is an obstacle they will remove it and the crew will be allowed to re-start. The race controller is to decide on circumstance or unfair distraction. This allowance may not be misused to compensate for a bad run.

PENALTY: If no obstacle or circumstance or unfair distraction found - no re-run and DNF.

15. In the event of no primary or back-up time being recorded by the timekeepers for a particular run, that crew will be allowed a second run, which should be made as soon as possible and may be added to the next round. If a boat is unable to make a re-run due to mechanical problems, then its previous best time at that meeting and on that track direction, will be recorded.
16. Once a crew has made their first run of the day they may not change their roles, that is, a driver cannot change places with the navigator. In the event of a crew member being unable to continue racing due to illness or injury and at the discretion of the sprint controller, substitute crew may be used provided that:

The substitute driver; May having completed all pre-competition formalities and already a competitor on the day can race another boat providing he/she is able to complete at least one qualifying round

before commencing the elimination rounds. Any previous times recorded by that driver will be disregarded.

Once eliminations have commenced, a substitute navigator may be used, but only from a previously eliminated crew and only after it is established that the previous navigator is unable to continue. A driver may not be substituted once eliminations have commenced.

PENALTY: Role changes or unauthorised substitution of crew: disqualification for the remaining rounds.

17. A crew must be ready to start in the correct running order in each round. If there is a problem, the starter or pit Marshal must be notified of the problem in advance of their start order. If sufficient notification is given, the crew will be allowed to start later in that round.
18. In the case of a "B" crew near the end of the running order, they will be allowed a start in the following round, with their time counting for the previous round.
19. If a problem with a boat occurs in a qualifying round, there is a two-minute time limit upon repairs. This time limit will commence from when the last boat in that particular round enters the pit pool at the conclusion of its run and the time will be displayed on the main timing system display (where practical). The time count ceases when the subject boat is moving toward the start line, under its own power, with both crew on board, all safety equipment in place and under control of the starter. From the top16 down, the time limit shall be ten minutes and will apply from the time the affected boat is due to start in order, other boats will continue to race until the time has elapsed. If the affected boat cannot continue after ten minutes has elapsed, the timer will record a DNS. (The time count ceases when the subject boat is moving toward the start line under its own power ready to race). The sprint controller will be responsible for keeping time in this instance. At all times, the pit marshal or starter must be kept informed as to the status of the boat. A time-out is declared if the scrutineer is required to inspect a damaged boat and he/she must be completely satisfied that the boat is safe and fit for racing. No further work may be carried out during a scrutineering "time out".

PENALTY: Not notifying Pit Marshal or Starter of a problem or an inability to start in order - DNS.

PENALTY: Exceeding the two or ten minute time limits - DNS.

19.1 In the event that a Dummy grid is to be used to stage boats for launching, the boats must be at the dummy grid within 5 minutes of their "Last Call". In the event that a crew notifies the race controller of a problem with their boat they will make good their repairs within the allocated time frame (see rule 19) at the dummy grid under the supervision of the race controller or his steward without impedence to any other crew.

20. Any boat, which suffers a heavy impact or obvious damage in a racing accident, must be re-scrutineered before further competition. The re-scrutineering process will take place after any work to repair damage to the boat has been completed, but shall have time constraints such as meeting the appropriate time limits or qualifying rounds. The boat may not be returned to the water until the scrutineer has declared it safe for competition. In the absence of a scrutineer the sprint controller will re-scrutineer the boat. Likewise, the crew must be checked by the ambulance or first aid crew and declared fit to resume racing.
21. On race day, there will be a minimum of two (2) qualifying rounds, but normally three. If the qualifying rounds are reduced for any reason once racing has begun, the first elimination will include all entrants affected. (Elimination rules apply to such rounds). Formation of the elimination rounds will be advised on the event programme, or at drivers briefing. The cut progression will be advised prior to the running of that segment, but will normally be 16-8-4-2. The running order from the top 8 down must be slowest first. Where there are insufficient numbers to make up an elimination round, the round will still be treated as such, until the relevant cut can be made. (Elimination rules apply to such rounds).
22. Due to a number of variables such as weather, accidents, crew and boat numbers, the sprint controller retains the right to vary the progression of the elimination cuts. Crews will be informed of variations in advance.

23. Regardless of the number of crews available, no crew may be included in the elimination rounds without recording a qualifying time.
24. During the eliminations, if two crews record equal times in a particular round and that time qualifies for the last spot in the next round, they shall both be included in that next round, even though it adds an extra boat to that round. The following cut however, will be as previously established.
25. In the elimination rounds, if more than one crew records a DNF in any elimination round, their respective positions in that round will be considered equal. In all instances, a DNF will score higher than a DNS.
26. In the top 2, if both crews record equal times they shall have a run-off in the same order as before, to determine the winner. If necessary, this process shall be repeated until a result is achieved.

902 - NEW RULES FOR CIRCUIT ENDURANCE CHAMPIONSHIPS

1. ORGANISATION

All races will be controlled by and remain the property of the U.I.M. In cases where International regulations do not exist then the national authorities will judge according to the general spirit of the event, considering U.I.M. circuit rules in groups 100, 200, 300 and 400. Any local rules must be accepted by the teams provided they are in the advance programme. The World Championship will be run over 4 events maximum with the possible addition of a 5th round, if this one is outside Europe, except pneumatics.

2. THE CIRCUIT

The overall shape of the circuit is not binding but must not be less than 3000 metres, and a maximum of 6100 metres. All circuits must be registered with their N/A and with the U.I.M. (Min. 3 months prior to a

race.) The turn buoys will be divided into each class so as not to have boats in different classes turning on the same turn buoy. For the catamaran classes, 2 distinct circuits will be set up, exterior circuit for Class I up to 1050 ccs and interior circuit for Classes II and III. There must be at least 750 metres between the main turn buoy.

For Pneumatics: The overall length of circuit must not be less than 2500 metres. The turn buoys for all classes will be the same. There must be at least 500 metres between the main turn buoy.

3. CLASSES

Catamarans classes: There will be three classes for the World Championship, based on the corresponding S classes.

- Class 1. Up to 1050cc
- Class 2. Over 1050cc and up to 2050cc
- Class 3. Over 2050cc and up to 3100cc

Engines that comply with EPA regulations will be allowed to compete with a 30% greater capacity in their corresponding classes.

V Classes: There will be 2 classes for the World Championship.

- Class 1. Up to 1050cc
- Class 2. Over 1050cc and up to 3100cc

Pneumatics classes: There will be 5 classes for the World Championship.

- Class 1. Up to 770 cc
- Class 2. Over 770 cc and up to 1060 cc
- Class 3. Over 1060 cc and up to 1550 cc
- Class 4. Over 1550 cc and up to 2050 cc
- Class 5. Over 2050 cc and up to 3150 cc

Engines that comply with EPA regulations will be allowed to compete with a 30% greater capacity in their corresponding classes.

V classes and pneumatics must NOT run with Catamarans.

Additional provisional classes for 2007 and 2008 for low emission engines complying with 2006 EPA rules (as per homologation sheet) for pneumatics :

PR 60 HP Horse-power of the engine not more than 60

PR 115 HP Horse-power of the engine not more than 115

PR 200 HP Horse-power of the engine not more than 200

PR ∞ Horse-power of the engine – unlimited

The races in these classes are run along with conventional classes. The classification can only be established if there is a minimum of 5 entries per event per provisional class. The organizer must provide the equipment necessary to confirm the power rating of the engine in accordance with UIM / Engine manufacturer recommendations, otherwise there will be no classification in provisional classes.

4. DURATION

The race will be for a minimum time period of 6 hours and maximum time of 24 hours continuous racing (see Part 17 also)

5. ENTRIES

All entries must be on the organising club's official form and entries must be sent in by the date as requested. Late entries may be accepted providing all paperwork is in order and that their inclusion does not affect the water capacity as homologated. Entry fee for the championship may be charged. Late entries may be fined.

6. VALIDITY OF DRIVERS

All drivers must be in possession of a current licence issued by his N/A for the class of boat that he wishes to race. He must also have the N/A permission to race. All other aspects refer to IUM rule 120. A driver must also have a current immersion test certificate if required by the U.I.M. for that class.

7. INSURANCE

Any driver who does not carry insurance to meet the requirement of the country in which they are racing, will have to pay, per boat, the required amount to a maximum of 190 euros.

8. TEAMS

For races up to 12 hours there must be a minimum of two pilots and a maximum of 4 pilots, and for races from 12 hours to 24 hours there will be a minimum of 3 pilots and a maximum of 4 pilots. Teams may practice more than the required number of pilots providing they have all paper work and licences in order. Team managers must notify the Control, 1 hour prior to the race as to their final pilots names and no alteration of the pilots list will be accepted for whatever reason. Failure to do so will lead to D/Q of the team. A pilot must not drive continuously for more than 2 hours. Any laps over the period will not be included. Minimum rest period for drivers is one hour.

9. TEAM MANAGERS

All entries must have a Team Manager who must not be a pilot. In a case where there is more than one boat in a team then the Manager can represent all entries in that team. All penalties and other race documentation at the race site will be forwarded to the Team Manager. The Team Manager must be present at all meetings and scrutineering.

10. ADVANCE PROGRAMME

The organisers of the race will forward the advance regulations to all N/A's in English and their own language within 48 days of such race. All aspects of the advance regulations will have at least all those details as listed in U.I.M. rule 202.

11. DRIVERS MEETING

It is mandatory for all drivers and Team Managers to attend driver's briefing. It will be in English and the language of the majority of the drivers present and held after scrutineering and at least one hour prior to practice.

12. PRACTICE

All new pilots to the course must complete at least 2 laps of practice.

13. STARTS

The start will be a flying start behind a pace boat. The signal to start will be via a Green flag.

14. FINISHES

The finish of the race will be after the lead boat has completed the time duration. This will be denoted by a chequered flag flown from control and the final positions will be at the time the other boats complete the required time period.

15. CLASSIFICATION

To be classified as a finisher and to gain points you must have completed at least 40% of the class winner's laps and take the chequered flag. Boats not running but complete at least 90% of the class winners distance will be scored after all boats that take the chequered flag.

16. POINTS

Points will be awarded in each competing class as follows

1st	20	9th	7
2nd	17	10th	6
3rd	15	11th	5
4th	13	12th	4
5th	11	13th	3
6th	10	14th	2
7th	9	15th and onwards	1
8th	8		

17. INTERRUPTED RACE

A race that has to be curtailed for one reason or another and it is impossible for the race to recommence then points will be awarded as follows:

Up to 25% of race time 20%

40% of race time 50%

60% of race time 75%

90% of race time 90%

Over 90% full points.

If a race is interrupted and can be recommenced within a reasonable period of time then the recommencement procedure will be as the start of the race less completed time. The time period remaining will be the total race time less 15 minutes and less completed time. The distance covered by each part of the race will be added together for the final result. The distance covered, the lap prior to the stoppage will be the laps taken. If the race has to be brought under a reduced speed then the pace boat will take the boats round in order there will be no overtaking. The restart will from the pace boat.

18. REPAIRS

All repairs must be carried out within your designated pit area.

19. FUEL

Fuel for racing must be provided by the organisers to a minimum standard of 95 Ron Unleaded fuel. All competitors must use the fuel supplied by the organisers at cost as indicated in the advance programme, any competitor failing to use this fuel will be disqualified. No race fuel can be stored at the boat pit position. All boats must be refuelled at the fuelling depot. Each pit area may have a maximum of 25 litres stored in a shock proof container and carry the race number of the boat. The sole purpose of this is for generators etc. and must not be used for the race boats except in the case where repairs to a boat necessitate the fuel tank being drained. In this case a max of 25 litres may be placed into the fuel tank of the boat to fire up the engine in the pits and to drive the boat to the refuelling station. The maximum amount of fuel that a boat can carry is 200 litres for Catamarans and 100 litres for V.Boats

The use of replaceable plastic tanks for fuel with the capacity of no more than 50 litres is allowed for Pneumatics.

For Pneumatics the maximum amount of fuel the boat can carry is as follows:

CLASS 1	60 liters
CLASS 2	100 liters
CLASS 3	150 liters
CLASS 4	200 liters
CLASS 5	200 liters

20. REFUELLING

Must be carried out at the refuelling station and with the engine off. No repairs of any kind can be undertaken at the refuelling point.

21. FUEL DEPOT

All personnel entering the fuel depot must not carry the following:

Cameras: Mobile Phones: Electrical items: Metal Objects: any device that can be ignited i.e. Lighters. All personnel must have rubber soled shoes.

22. PENALTIES

Any sanction against a driver (Yellow cards or disqualification) will be reported to the U.I.M. Should a driver be disqualified from that event under any rules of the U.I.M. then the team may continue providing they have the minimum number of drivers. All other penalties will be reported to the Team Manager and displayed at race control.

Fuel infringement	8 laps
Race infringements	5 laps
Light infringements	(after 2 laps of notification) no laps will be scored.
Craning infringements	8 laps
Failure to attend scrutineering or drivers briefing	5 laps
Flag Infringement	5 laps
Priority of boats	5 laps

23. PROTESTS

The Team Manager on behalf of his driver can make a protest. No collective protests will be accepted. They must be written in English with full details and if appropriate the U.I.M. rule. The fee for a protest is fixed at 150 euros and for a protest against an engine is fixed at 380 euros. Protest will be heard if possible within one hour of the protest being accepted and the result of any such protest will be given to the Team Manager and driver if possible. If a protest is upheld and laps have been deducted at the next posting of positions the laps will be re - introduced. If a protest comes within the last hour of racing then the protest will be heard as soon as possible and the final result will be not be posted until the protest has been heard. Protest on the final results must be made within half of one hour.

24. YELLOW/RED CARDS

Yellow cards can only be given by the OOD or the U.I.M. commissioner for offences on the water. They must be issued to the Team Manager or the driver on the official U.I.M. form. Other offences are covered within rule 406.06 of the U.I.M.

25. APPEALS

Appeals against any protest not upheld see U.I.M. rule 405.

26. POSTING OF POSITIONS

Positions will be posted every half hour for the first 2 hours then hourly and every half hour for the last 2 hours.

27. BOATS BROKEN DOWN ON COURSE

Any boat that breaks down on the course cannot refuse a tow and must be towed in the direction of the course, unless derogation is granted, if the width of the water level allows this tow in full safety. This must be specified on the advance program. It is forbidden to be towed against the race direction on the race course.

28. PRIORITY OF BOATS

Rescue and pace boats have priority at all times. Entering the pit land and refuelling lane must be done at reduced speed and no overtaking unless a boat has become stationary. All boats entering the pits or refuelling area have priority over those departing.

29. RESCUE

There must be at least one rescue boat for every 250 metres of course and that the course must be visible at all times from at least two rescue boats. There must be at least one rescue boat every 1000 metres capable of carrying a stretcher or that the boat must be a drop front dory.

30. SCRUTINEERING

All boats must be scrutineered before entering the water. It is mandatory for all drivers to be present and the Team Manager. All drivers must be able to prove that they fit within the craft as per U.I.M. rules. The OOD and U.I.M. commissioner will rule upon any such cases that infringe U.I.M. rules on cockpits. Each pilot must have his own helmet and life support vest and this must be produced at scrutineering. All boats must be presented to scrutineers with pickle forks dismantled and boats must have a spare pair that must be presented to the scrutineers.

31. CRANES

In the event of a crane being used for launching there will be a minimum of one crane per 15 boats. If launching is by slipway then one launch vehicle per 15 boats. The slipway must be large enough to allow the number of launch vehicles to work at the same time.

32. FLAGS

Red: Race terminated return to the holding area and await instructions

Yellow: Danger on circuit

Black: With race number fixed – driver to return immediately to the pits

Chequered black & white: Race completed

Yellow: Pace boat on circuit – no overtaking and reduce speed

Green: Race commenced/recommended

33. TURN BUOYS

Turn buoys will be of a single colour either Orange or Red unless there are turns of both left and right then for left hand turns the buoy will be Orange and for right hand turns the buoys will be yellow.

For hitting a turn buoy no penalty.

For dislodging or destroying the first turn buoy – 5 lap penalty

For dislodging or destroying the second turn buoy – 10 lap penalty

Destroying a turn buoy – the cost of replacement will be charged to the offending team. Maximum cost 1500ff (euros) per buoy. Each turn will have 2 turn buoys.

34. POST INSPECTION

The first three boats in each class will render themselves to the “parc ferme” for inspection immediately after the end of the race. Any boat failing to do so will be D/Q from that race. The only persons allowed in “parc ferme” are the drivers, the Team Manager and two mechanics. No other personnel are allowed.

35. MACHINERY

Only homologated single engines can be used. The engine block must remain the same as started. All other parts may be changed. All engine blocks will be marked one hour prior to the commencement of the race. more than one engine can be used in practice.

Use of power trim is allowed for pneumatics. The height of the motor must remain fixed while racing for pneumatics.

36. HULL

The hull as started is the only hull to be used. More than one hull can be used in practice providing it passes all scrutineering. Running repairs can be carried out to hulls at their own pit area. All repairs must be inspected by the scrutineers before re-entry to the race.

37. NAVIGATION LIGHTS

Boats racing during night hours must have navigation lights as follows:

Single red to Starboard min 5 watt

Single Green to port min 5 watt

Two sets of red lights separate installed to the stern of the boat min 5 watts each with back-up batter supply.

2 spot light minimum to the front of the boat 36 watts minimum. These lights must not be more than 2 metres from the front of the boat. Drivers must carry a water-proof torch within the boat.

38. SLINGS

Each boat must carry its slings at all times if launch is by crane, whilst on the water and must comply with the safety rules and regulations of rule 205.12 of the U.I.M. Drivers or mechanics must not ride in boats whilst the boat is being craned.

39. NATIONAL FLAGS

All boats will carry the national flag of all competing drivers.

40. U.I.M. PENNANTS

It is mandatory for all boats to carry the U.I.M. Logo to both side of the boat.

41. BUOYANCY

All boats must carry sufficient buoyancy to keep their boat afloat.

42. FIXING EYE

A reinforced cockpit boat must be fitted at the bow with two mooring eyes, one at the top and one at the bottom, eye not less than 25mm and not further than 250mm from the front. The fixing shall be strong enough to tow a boat partially submerged. A tow rope must be fixed. It must not be longer than the length of the hull.

43. PUBLICITY

The organising club and national authority can request that any offences advertising or any that conflicts with the sponsor or sponsors may request it to be covered throughout the duration of the race. All other aspects – see rule 203.051.

44. MEDICAL COVER

The minimum cover for the duration of the race and practice is for two ambulances on station at all times and two doctors, one to be trauma trained. It is advisable to have two stations.

45. DRUG TESTING

All drivers can be subjected to drug and alcohol tests. Any refusal will be deemed as a failure and the drive disqualified. Any tests that prove positive, the drive will be disqualified and reported to the U.I.M. All other aspects – see rule 205.02.02.

46. PRIZES

The U.I.M. will provide Gold, Silver and Bronze medals at the completion of the series of races and the Champions will receive their medals at the last race. The organisers will provide trophies for the first three in each U.I.M. class at each event. Prize giving must be within one hour of the completion of the race or, if protests are being conducted then it will be 30 minutes from completion of protests.

47. RESULTS

The results will be forwarded to the U.I.M. offices within 24 hours of the completion of the event.

The general classification will be drawn on additional points of all rounds per pilot(s).

In case of an ex æquo the points obtained in the longest endurance race will determine the winner(s) (there could be various ex æquo positions if it concerns one same team).

In all events, the pilots will be classified and not the boats.

48. U.I.M. COMMISSIONER

A U.I.M. Commissioner will be present throughout the event and the costs will be borne by the organising club. The club must make Hotel arrangements for all the nights that the Commissioner will be present. For events of more than 12 hours, 2 Commissioners will attend, one of which is the Senior. The U.I.M. will decide on seniority.

49. PACE BOAT

It is mandatory that a pace boat be launched read for use throughout the duration of the event and should there be a need for the race to be brought to a much reduced speed, then the pace boat will lead the leading boat flying a yellow flag until such time as the course is clear to race. All boats must remain in the order that they are in with no overtaking permitted. When the race is due to be restarted the yellow flag will be dropped and the green flag raised. When the pace boat marshal is happy that all is in order to restart he will drop the green flag. This is the only signal to recommence racing.

50. RACE NUMBERS

In the event that two numbers are identical, then the team who enter first can keep their race number. The Scrutineer will issue a further number to the Team and it is the team's responsibility to replace the number. Race numbers must be on the race trailer. An organised will, if possible, notify any team of a clash of numbers prior to scrutineering. Number one is reserved for the winner of the U.I.M. world championship. For all night races the numbers must be in luminescent white on a black background 40 x 40. All numbers must be fixed to both sides of the boat on the cell, for Catamarans only, just behind the drivers head position. For V. Boats the number must be vertical and behind the drivers head.

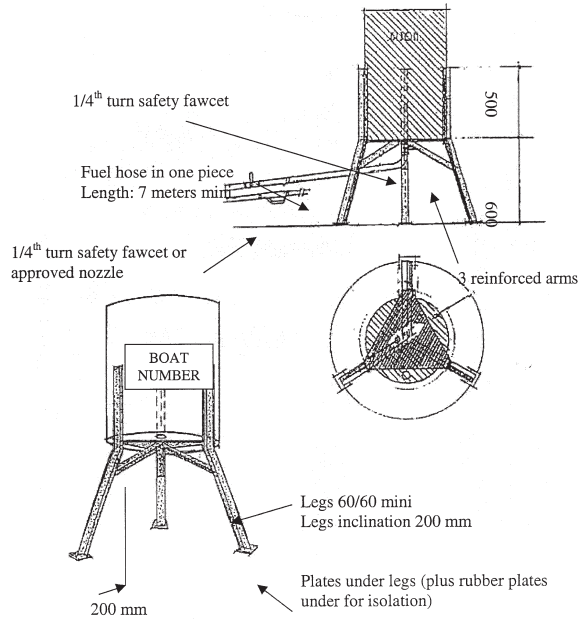

904 - HYDRO SPRINT RULES

This regulation is intended to provide for specific matters related to the method and rules of motorboat racing conducted by those organizers appointed to by Hydro Sprint International Ltd (H.S.I.)

The Hydro Sprint rules are originated from the Korean style motorboat racing, run by Seoul Olympic Sports Promotion Foundation.

Chapter 1. General Provisions

Article 1 (Purpose)

Article 2 (Definition)

Chapter 2. The Operation of Motorboat Races

Section 1. Motorboat Racing

Article 3 (Race Notification)

Article 4 (The Number of Races)

Article 5 (The Types of Races)

Article 6 (Racing Distances)

Article 7 (Members of the Racing Operation Council)

Section 2. Application to Participate in Motorboat Racing

Article 8 (Application)

Article 9 (Notice of Acceptance)

Article 10 (Cancellation of Application)

Section 3. Inspection and Confirmation of Qualifications

Article 11 (Confirmation of Qualifications)

Article 12 (Confirmation Inspection)

Article 13 (Confirmation of Drivers, Boats, and Motors)

Article 14 (Inspection Before Start)

Article 15 (Cancellation of Racing)

Section 4. Organization of Racing Schedules

Article 16 (Organization of Racing Schedules)

Article 17 (Announcement of Racing Schedules)

Section 5. Drivers and Motorboats

Article 18 (Motorboat)

Article 18-1 (Racing Attire)

Article 19 (Registration Number Plates)

Article 20 (Fuel and Lubricator)

Section 6. Securing Fairness on Races

- Article 21 (Motorboat Racing Sanction Deliberation Committee)
- Article 22 (The Kinds of Sanctions)
- Article 23 (Banning/Suspension of Being Involved in Races)
- Article 24 (Suspension of Participating in Races)
- Article 25 (Written Warning and Caution)
- Article 26 (Report of Facts)
- Article 27 (Decision on Sanctions)
- Article 28 (Formal Objection)
- Article 29 (Objection Processing)

Section 7. Motorboat Racing Judging Methods

- Article 30 (Aim of Decision)
- Article 31 (Three Factors of a Judge's Decision)
- Article 32 (Judge's Decision Standards)

Section 8 Awards for drivers – see H.S.I. Handbook

Section 9 Admission Fee and Public order – see H.S.I. Handbook

Section 10 Winner voting and Betting System – see H.S.I. Handbook

Chapter 3. Racing Rules

Section 1. General Regulations

- Article 33 (Racing Method)
- Article 34 (Definition of Glossaries)
- Article 35 (Waiting for Racing)
- Article 36 (Exclusion from Racing)

Section 2. Introduction Run

- Article 37 (Racing Method)
- Article 38 (Preparation for Racing)

Section 3. Start

- Article 39 (Preparation for Start)
- Article 40 (Start Signal)
- Article 41 (Waiting Behavior)
- Article 42 (Effective Start)
- Article 43 (Announcement of Race Suspension/Disqualification)
- Article 44 (Confirmation of Finishing/Order)
- Article 45 (Detailed Regulations)

Section 4. Navigation

- Article 46 (Ban on Touching)
- Article 47 (Collision Avoidance)
- Article 48 (Changing Direction)
- Article 49 (Turn Mark Rotation)
- Article 50 (Passing)
- Article 51 (Others)

Section 5. Void Race and Disqualification of Racing

- Article 52 (Ineffective Race)
- Article 53 (Disqualification for Racing)
- Article 54 (Disqualification)
- Article 55 (Investigation into Accidents)

(Appendix 1)

Acknowledgement and agreement of UIM Anti Doping Rules

(Appendix 2)

Operation Rules of Sanction Deliberation Committee

Chapter 1. General Provisions

- Article 1 (Purpose)
- Article 2 (Applicable Scope)

Chapter 2. Motorboat Racing Sanction Deliberation Committee

- Article 3 (Establishment and Composition)
- Article 4 (Convention)
- Article 5 (Decision-making)
- Article 6 (Agenda)
- Article 7 (Participation of the Motorboat Driver Subjected to a Sanction)

Chapter 3. Sanctions

- Article 8 (Application for Sanction and the Procedure Involved)
- Article 9 (Processing of a Sanction Procedure)
- Article 10 (Decision on a Sanction)
- Article 11 (Sanction Appreciation and Its Standards)
- Article 12 (Added Sanction)
- Article 13 (Reduced Sanction)

Chapter 4. Lodging an Appeal

Article 14 (Lodging an Appeal)

Article 15 (Re-deliberation)

Article 16 (Exclusion and Avoidance)

Article 17 (Effects of the Original Sanction)

Article 18 (Decision on Repairs)

Annexed Tables

Table 1 Members of the Racing Operation Council

Table 2 Medical criteria for Participating Drivers

Table 3 The standards of Boats and Motors

Table 4 Colors of racing uniforms and Motorboats in their Number

Table 5 Racing Course

(Annex Form 1) A List of the People Who Have Submitted a Written Apology

(Annex Form 2) Sanction Notice

(Annex Form 3) Application for an Appeal

UIM HYDRO SPRINT RULES

CHAPTER 1. GENERAL PROVISIONS

Article 1 (Purpose)

This regulation is intended to provide for specific matters related to the method and rules of motorboat racing conducted by those organizers (hereinafter called “organizer”) appointed to by Hydro Sprint International Ltd (H.S.I.)

Article 2 (Definition)

The Hydro Sprint refers to a type of race, combining a race and a betting system together, contributing to governmental tax profits, activating local economy, providing thrills and satisfaction to the public involved, and so on.

CHAPTER 2. THE OPERATION OF MOTORBOAT RACES

Section 1. Motorboat Racing

Article 3 (Race Notification)

- a. If an organizer plans to hold a Hydro Sprint, it must announce its annual race schedule, including the following items, 20 days before the date of the first race:
 1. Racing places, dates, and times
 2. The types of races, racing distances, and prizes on each racing date
 3. The qualifications and application due dates of drivers
 4. Others
- b. The organizer may change or cancel the annual race schedule, which is specified in Article 3-a., in the case of an emergency, such as a natural disaster.

Article 4 (The Number of Races)

- a. The organizer can hold up to 15 races a day.
- b. A driver or a motorboat may participate in two races a day.
- c. A driver or a motorboat that participates in two races a day, must have an interval of more than two races between its designated races

Article 5 (The Types of Races)

- a. The organizer may hold the following two types of races:
 1. Online start races
 2. Flying start races
- b. The races specified in Article 5-a. must follow the racing rules in Chapter 3.

Article 6 (Racing Distances)

Racing distances must be 1,800 meters or longer.

Article 7 (Members of the Racing Operation Council)

- a. The organizer must have the following racing operators to hold a race.
 1. President of the Racing Operation Council
 2. Vice President
 3. Facility Managing Director
 4. Judging Director
 5. Fairness Controller
 6. Racing Operator
 7. Ticket Sales Managing Director
 8. Broadcasting Director
 9. Betting Shop Managing Director
 10. Driver & Motorboat Managing Director
- b. The Council members, composed of up to 20 people, may have assistants to help with their tasks.

- c. The Council members are the heads of the relevant departments (including team managers). If they are absent, the organizer may designate substitute members. Each operator's tasks are illustrated in Annexed Table1.
- d. If a Council member finds that his or her tasks are related to another operator's tasks, the member must immediately report to or inform the Director of the Racing Operation Council and the relevant operator.

Section 2. Application to Participate in Motorboat Racing

Article 8 (Application)

Those who want to participate in a motorboat race must submit the application form suggested by the organizer.

Only those drivers who have received a super license by the UIM will be entitled to participate to the International Hydro Sprint Motorboat races.

The UIM Super license will be issued upon receipt of

- Confirmation that the applicant fulfills all regulations as stated in the Hydro Sprint Management Regulations of the H.S.I. Handbook.
- Receipt of the acknowledgement and agreement by the driver to abide to the anti-doping regulations based upon the world anti-doping code (form as per appendix 1 at the end of these rules).
- Receipt of the super license fee

Article 9 (Notice of Acceptance)

When the applicant is accepted according to the regulations in Article 8, the organizer must immediately notify the applicant of the meeting place and time, and other requirements for the race by mailing an acceptance letter, or by phone or e-mail (including text message).

Article 10 (Cancellation of Application)

- a. Those who want to cancel their application must give in writing the reason for the cancellation request, before receiving notice of acceptance as specified in Article 9. If the reason is sickness, they must attach a medical certificate.
- b. After receiving notice of acceptance, applicants cannot cancel the application, unless the organizer changes the racing schedule or finds their reason as valid.

Section 3. Inspection and Confirmation of Qualifications

Article 11 (Confirmation of Qualifications)

- a. Those who receive notice of acceptance, according to the regulations in Article 9, must go to the designated place by the specified date with the following items, and be confirmed their qualifications by the racing operator.
 1. Notice of acceptance, as specified in the regulations of Article 9
 2. Driver registration card and the official driver pocketbook
- b. Boats or motors to be used in the race will be chosen by drawing lots before the first racing date. If all the drivers participate in the lot, an electronic lottery method will be used, such as ARS(Automatic Reply System) or the Internet, or representative drivers will use a direct drawing method.
- c. If the driver cannot arrive by the designated date, as specified in Article 11-a, for a valid reason, the driver must notify a racing operator of the reason and an estimated time of arrival in advance, get approval from him, and follow his instructions.

Article 12 (Confirmation Inspection)

- a. Those who have confirmed their qualifications and had a motorboat assigned must get a confirmation inspection from the racing operators and judges, a day before the racing date, from the date they were admitted to attend each motorboat race.

- b. During the confirmation inspection, the racing operators must make a list of drivers who have passed the inspection, after they check racing aptitudes including physical condition, according to the physical checkup standards for drivers in Annexed Table 2.
- c. Selected Boats and motors must be checked to ensure they are safe and without structural defects, according to the Hydro Sprint management regulations (See H.S.I. Handbook). Then, motors must be installed in the selected boats. The boats and motors that have passed the final checkup while racing are attached with certificates.

Article 13 (Confirmation of Drivers, Boats, and Motors)

- a. The Racing operators and judges must confirm the drivers, boats, and motors that will participate in the races, according to the results of the confirmation inspection, make a confirmation list of them, and notify the operator in charge. Those who have obtained the approval of the racing operators, according to the regulations in Article 11-a., are confirmed as drivers.
- b. The drivers who have been confirmed participation in the races, according to the regulations in Article 13-a., cannot cancel their participation in the race, unless their reasons are found to be valid.

Article 14 (Inspection Before Start)

- a. The drivers, boats, and motors that have been confirmed as participating in the races must get to the waiting room an hour before the start time, and be inspected by the racing operators and judges.
- b. The racing operators and judges must check the following things when carrying out the inspection before the start, according to the regulations in Article 14-a.
 1. Whether or not, there are any changes since the confirmation inspection specified in Article 12
 2. Whether or not, If the conditions satisfy the regulations in Articles 18 and 20

- c. If the conditions at the time of the confirmation inspection need to be changed before the start, the changed conditions must be checked again through an inspection, which corresponds to the confirmation inspection.
- d. The drivers, who meet the conditions of the regulations in Article 11-a, but have not had their qualifications checked or had a confirmation inspection, must have the relevant inspection, at the inspection before the start time, as specified in Article 14-a.
- e. The drivers, boats, and motors that participate in two races a day can get a collective inspection.

Article 15 (Cancellation of Racing)

The racing operators and judges may cancel the participation of drivers, boats, or motors, if they are expected to pose severe obstacles to the operation of the races, in relation to the regulations in Articles 12 and 14.

Section 4. Organization of Racing Schedules

Article 16 (Organization of Racing Schedules)

The racing operators must assign a number to each race, and establish racing schedules for the drivers, boats, and motors that have been confirmed as participating in the races, according to the regulations in Article 13.

Article 17 (Announcement of Racing Schedules)

- a. After racing schedules are made according to the regulations in Article 16, the racing schedules must be announced in public.
- b. Drivers cannot raise objections to the racing schedules, which were established according to the regulations in Article 17-a.
- c. If drivers, boats, or motors are modified, after the racing schedules have been announced according to the regulations in Article 17-a, the modifications must be quickly made known at the appropriate places, including the racing place.

Section 5. Drivers and Motorboats

Article 18 (Motorboat)

Types and specifications of motor and boat used in Hydro Sprint Races are illustrated in Annexed table 3

Article 18-1 (Racing Attire)

- a. Drivers must wear the following attire:
 1. Racing uniform (A long-sleeved shirt and long pants)
 2. Helmet
 3. Life vest
 4. Protection pads and shoes
- b. The colors of racing uniforms and numbered motorboats are illustrated in Annexed Table 4.
- c. The organizer may allow drivers to display advertisements on their clothing.

Article 19 (Registration Number Plates)

- a. Drivers must attach a set of registration number plates to their motorboats.
- b. The registration number plates must be positioned on both sides, in the middle of the motorboat deck.

Article 20 (Fuel and Lubricator)

Drivers must use the fuel and lubricator specified by the organizer. If they mix them, they must follow the ratio that was decided by the organizer.

Section 6. Securing Fairness on Races

Article 21 (Motorboat Racing Sanction Deliberation Committee)

- a. In order to secure fairness in motorboat races, the organizer will establish a Motorboat Racing Sanction Deliberation Committee to examine and decide on applications for sanctions and objections.
- b. The organizer will decide on the composition and operation of the Motorboat Racing Sanction Deliberation Committee in detail.
- c. The operation rules of the Motorboat Racing Sanction Deliberation Committee is illustrated in appendix 2.

Article 22 (The Kinds of Sanctions)

The organizer can take the following sanctions to ensure fairness in motorboat racing:

1. Sanction on being involved in races: The driver's registration is cancelled, and the driver is permanently banned from being involved in races or registering as a driver.
2. Suspension of being involved in races: The driver's registration is cancelled, and the driver is banned from being involved in races or registering as a driver for 1 to 5 years.
3. Suspension of participating in races: The driver is banned from participating in races for less than a year.
4. Written warning and caution: The driver receives a written warning or caution.

Article 23 (Banning/Suspension of Being Involved in Races)

In the following cases, the organizer may ban or suspend the driver from being involved in races:

1. The driver forged or changed the application for the purpose of wrongdoing.

2. The driver did not exert competence to the maximum for the purpose of wrongdoing.
3. The driver received, requested, or promised assets or property interests to affect the fairness of the races.
4. The driver inflicted or tried to inflict damage on other drivers to affect the fairness of the races.
5. The driver provided or tried to provide a specific person with information on the results of the races.
6. The driver conspired over or signed an unfair agreement on the races.
7. The driver interfered with races or racing operators.
8. The driver disobeyed the racing operators' inquiry, judgment, or instructions.
9. The driver applies to Article 16-b of the Hydro Sprint Management Regulations in the H.S.I. Handbook.
10. The driver used banned substances for the purpose of wrongdoing.

Article 24 (Suspension of Participating in Races)

In the following cases, the organizer may suspend the driver from participating in races for less than a year:

1. The driver violated the regulations in Articles 10-b, 11, 12-a, 13-b, 14-a, 18, 19, or 20
2. The driver violated the regulations in Article 47 or 65.
3. The driver applies to Article 23-7 or 23-9 and committed a minor wrongdoing.
4. The driver violated the regulations in Article 26.
5. The driver did not exert competence to the maximum during the race.
6. The driver is considered to have conspired with other drivers in advance.

7. The driver is considered to have helped or interrupted other drivers during the race.
8. The driver is considered to have conducted an act that may provoke spectator suspicion during the race.
9. The driver is considered to have conducted an act that may provoke spectator suspicion during the introduction racing or while leaving after the race.
10. The driver is considered to have been negligently or passively involved in the race without any special reason.
11. The driver is considered to have lost a chance to win due to dangerous racing during the race.
12. The driver has consecutively had bad results.
13. The driver used bad language when discussing the race after finishing.
14. The driver degraded himself or herself during the race.
15. The driver has received a written warning twice.
16. The driver interfered with the fair and safe operation of the race.

Article 25 (Written Warning and Caution)

The organizer may give a written warning or caution to drivers who interfere with the fair and safe operation of the race, although the act is not severe enough to have them receive a ban from participating in races.

Article 26 (Report of Facts)

In the following cases, drivers or judges must report to a racing operator immediately after noting the following:

1. The driver conspired over or signed an unfair agreement on the races.
2. The driver received, requested, or promised assets or property interests to affect the fairness of the races.

3. The driver inflicted or tried to inflict damage on drivers to affect the fairness of the races.
4. The driver affected or tried to affect the fairness of the races.

Article 27 (Decision on Sanctions)

- a. If a racing operator or the head of a relevant department needs to take one of the sanctions in Article 22, he or she must send a letter of opinion to the Motorboat Racing Sanction Deliberation Committee.
- b. The Motorboat Racing Sanction Deliberation Committee may ban a person who receives a sanction, according to the regulation in Article 27-a, from participating in races, or postpone payment of the result prizes and fees to the driver, until a decision is made on the sanction.

Article 28 (Formal Objection)

- a. If a driver who receives a sanction from the Motorboat Racing Sanction Deliberation Committee has an objection to the sanction, only the driver can lodge an objection.
- b. The driver must submit an application for objection to the Chairman of the Motorboat Racing Sanction Deliberation Committee within 30 days of receiving the sanction.

Article 29 (Objection Processing)

- a. The objection must be processed within 30 days of accepting the application.
- b. If a decision is made on the objection, the driver must be immediately notified of the result.

Section 7. Motorboat Racing Judging Methods

Article 30 (Aim of Decision)

A decision on a driver who conducted an action in conflict with the motorboat racing rules must be comprehensively reached by closely examining and fully inquiring into the three factors that are the cause, passage and result.

Article 31 (Three Factors of a Judge's Decision)

The aim of the three factors specified under Article 3 stems from the following:

1. Cause: How did the action occur? The motivation.
2. Passage: How did the action progress? The process.
3. Result: How did the results from the action affect the racing or other drivers?

Article 32 (Judge's Decision Standards)

Specific standards for the judge's decision on the motorboat racing rules are provided to judge candidates by H.S.I at the Training Center.

Section 8. Awards for Drivers – see H.S.I. Handbook

Section 9. Admission Fees and Public Order – see H.S.I. Handbook

Section 10. Winner voting and Betting System – see H.S.I. Handbook

CHAPTER 3. RACING RULES

Section 1. General Regulations

Article 33 (Racing Method)

Participating drivers travel counterclockwise around the racing course as illustrated in Annexed Table 5.

Article 34 (Definition of Glossaries)

The definition of the glossaries used in the regulations is as follows:

1. "Racing Course" refers to the water used for motorboat racing, which is clearly marked by buoys.
2. "Waiting Area" refers to the water, which is clearly marked by buoys at intervals of over 150 meters, in the direction of the second turn mark from the start line.
3. "Introduction Run" refers to a racing to introduce participating drivers and motorboats to the audience.
4. "Online start race" refers to a race in which all the drivers leave the start line at the same time.
5. "Flying start race" refers to a race in which drivers pass the start line from the waiting course within a specified time.

Article 35 (Waiting for Racing)

Participating drivers must be in the waiting room one hour before their race time, except when the judges allow them for a specific reason.

Article 36 (Exclusion from Racing)

In the following cases, the judges may prohibit the driver from racing:

1. When the driver used banned substances that may temporarily increase or decrease racing competence.

2. When the driver did not get to the waiting room an hour before the race time.
3. When the driver did not follow the racing operator's orders or instructions in the racing place.
4. When the driver cannot participate due to bad physical condition.
5. When it is necessary to secure the fair and safe operation of races.

Section 2. Introduction Run

Article 37 (Racing Method)

- a. Participating drivers must be in the waiting room before the scheduled start time, and when the judge introduces them, they must be routinely racing in the racing course in their designated motorboats.
- b. The judge must introduce drivers before starting the race as follows:
 1. The judge must introduce drivers 30 minutes before the race or immediately after the previous one. The introduction run may be carried out one or two times.
 2. Drivers must be racing in a row in the order of the driver number when they are introduced. They must not be racing in parallel with or ahead of other drivers.
 3. Drivers must be racing in normal racing positions and must not make noise or conduct an act that may provoke the audience's suspicion.
- c. The judge must supervise the whole process of introduction run to ensure that drivers are introduced in an appropriate and efficient way.

Article 38 (Preparation for Racing)

- a. Drivers who finish the introduction run normally must wait in the waiting room.
- b. Drivers must not change the state of their motorboats after finishing the introduction run.

- c. Drivers, who have not finished the introduction run normally, cannot participate in their races.

Section 3. Start

Article 39 (Preparation for Start)

- a. Drivers must get in their motorboats in the order of the race number, according to the judge's instructions on the preparation for starting.
- b. In the case of online start races, drivers must fix their motorboats to the starting machine.
- c. In the case of flying start races, drivers must leave the moorings toward the waiting area.

Article 40 (Start Signal)

- a. In the case of online start races, the start signal depends on the judge's flag signaling.
- b. In the case of flying start races, the start signal is marked by a number plate or a time lamp until a minute before the start time, and then after by a start signal clock.

Article 41 (Waiting Behavior)

- a. "Waiting behavior" refers to 'waiting and entrance running' from the moment drivers leave the moorings to the moment right before the drivers start racing, in the case of flying start races.
- b. "Waiting running" refers to the running from the moment motorboats leave the moorings to the moment they turn toward the front at the starting line. "Entrance running" refers to the racing from the moment of waiting running to the moment right before the drivers pass the start line.
- c. While waiting running, drivers must run counterclockwise in the waiting area, in the order of the small turn prevention buoy and the second turn mark. They must not run outside the waiting area.

- d. After turning toward the front at the starting line, drivers must run forward for entrance running, except when there is enough space inside, as other drivers attempt to turn again.
- e. When the driver turns around the inner line again, after turning toward the front at the starting line, the driver must start entrance running from the 5th or 7th course in principle.

Article 42 (Effective Start)

- a. The effective start of each race is as follows:
 - 1. Online start races: Drivers must leave the starting line at the same time, as the devices of the starting machine are simultaneously released.
 - 2. Flying start races: Drivers must pass the starting line within 1.5 seconds from the start time, in the state of waiting behavior.
- b. In the case of flying start races, start violations are as follows:
 - 1. Flying: Drivers pass the starting line before the start time.
 - 2. Late: Drivers pass the starting line 1.5 seconds after the start time.
- c. In the case of start violations, drivers may restart, but may only restart twice. Otherwise, the driver will be held responsible. In the case of flying start races, if a flying or a late start occurs again at the second trial, the race will continue excluding the drivers who violated the starting rules. The betting tickets for the driver excluded will be returned to the ticket purchasers.
- d. The driver who caused a restart due to a flying or a late start is banned from participating in races for a certain period of time, according to the regulations in Article 24.

Article 43 (Announcement of Race Suspension/Disqualification)

If a race is suspended or a driver is disqualified for one of the reasons specified in Article 52 (Ineffective Race), the judge must immediately notify the purchasers of betting tickets of the reason.

Article 44 (Confirmation of Finishing/Order)

- a. Finishing is confirmed in the order that the tip of the motorboat crosses the finish line.
- b. Drivers must get to the finish line within 30 seconds of the first driver finishing.
- c. The finishing order is confirmed by the judge, but it may be changed if there is a change in the race, as specified in the regulations of Article 43.
- d. The finishing order, which was confirmed according to the regulations of Article 44-a and 44-b, is final in determining the payment for the people who bet on the winner in the betting of the race. It cannot be changed for any reason later.

Article 45 (Detailed Regulations)

The organizer will decide on detailed regulations on the judgment standards of the racing rules.

Section 4. Navigation

Article 46 (Ban on Touching)

A motorboat must not put a race in danger by touching or closely approaching the other motorboats, except when it is obstructed by another motorboat or when there are valid reasons.

Article 47 (Collision Avoidance)

- a. If two motorboats approach each other, they must avoid the danger of collision by racing as follows:
 - 1. If they are facing each other, each one must turn in a starboard direction.
 - 2. If they cross, the motorboat that sees the other one to the starboard must not race across its front.

- b. If the motorboat has to change course due to an obstacle, it must send a signal to the other motorboats, which then must try not to interfere with the racing of the motorboat that has sent the signal.

Article 48 (Changing Direction)

If more than two motorboats are racing closely in parallel, they must not interfere with the racing of each other by turning to the side of the other motorboat, except when there is an obstacle or when there are valid reasons.

Article 49 (Turn Mark Rotation)

- a. Motorboats must turn counterclockwise around the turn mark.
- b. In the case of Article 49-a., a motorboat must neither damage nor sink the turn mark, except when it is obstructed by another motorboat or when there are valid reasons.
- c. If more than two motorboats simultaneously turn around the turn mark, the motorboat on the outside must give enough space to the motorboat on the inside.

Article 50 (Passing)

When a motorboat passes another motorboat, it must run to the port side, except when there is plenty of space.

Article 51 (Others)

- a. Drivers must not race using wind, waves, flows, or stirring water with hands, except when the motorboat is broken or there are valid reasons.
- b. Drivers must not interfere with the running and operation of rescue boats.
- c. If there is a damaged or overturned motorboat, or a driver falls into the water, drivers must race maintaining a safe distance.
- d. Drivers, who have been disqualified or cannot race, must quickly leave the course so that the other motorboats are not interrupted.

Section 5. Void Race and Disqualification of Racing

Article 52 (Ineffective Race)

The judge may rule the race as void in the following cases, and postpone or suspend the race:

1. No drivers finished the race.
2. The race could not be completed normally due to natural disaster or blackout.
3. It is impossible to hold a normal race, due to the interruptions of people or animals.
4. The race is severely interrupted by the spectators, including stone throwing.
5. The turnaround announcer did not notify drivers of the turnaround or notified incorrectly during the race.
6. The race was not held in a fair, safe way, due to reasons for which drivers are not held accountable.

Article 53 (Disqualification for Racing)

The judge must prohibit the driver from racing in the following cases.

1. When the driver violated the regulations in Articles 18, 19, 51, 52-b., or 53.
2. When the driver cannot participate in a normal race, because a driver fell into the water or was hurt while racing in the waiting area or at the start time, or because the motorboat was overturned, sunk, burnt, or damaged.
3. When the speed of the motorboat was considerably reduced, due to the imbalance of the motorboat or floating materials before or at the start time.

Article 54 (Disqualification)

In the following cases, the judge must give a caution or warning, depending on the seriousness of the violation:

1. When the driver violated the regulations in Articles 20, 47, 60, or 65.
2. When the driver did not race at full throttle to win the race.
3. When the motorboat was overturned or a driver fell into the water while racing.

Article 55 (Investigation into Accidents)

In the following cases, the judge must immediately investigate the reasons and report the results to the president of the Racing Operation Council.

1. The motorboat did not start.
2. The motorboat did not finish.
3. The speed of the motorboat was significantly slow.
4. There were other accidents.

(APPENDIX 2)

OPERATION RULES OF SANCTION DELIBERATION COMMITTEE

CHAPTER 1. GENERAL PROVISIONS

Article 1 (Purpose)

Pursuant to Article 21 of the UIM Hydro Sprint Enforcement Regulations, these regulations are intended to provide specific matters, related to the organization and operation of the Motorboat Racing Sanction Deliberation Committee (hereinafter referred to as the «committee») to secure fairness in motorboat racing.

Article 2 (Applicable Scope)

- a. The regulations apply to motorboat drivers.
- b. Unless otherwise specified in the Motorboat Racing Act and miscellaneous regulations, the regulations apply to the organization and operation of the committee.

CHAPTER 2. MOTORBOAT RACING SANCTION DELIBERATION COMMITTEE

Article 3 (Establishment and Composition)

- a. The Motorboat Racing Sanction Deliberation Committee is composed of a chairman and 6 to 14 members, who are selected by the organizer
- b. The Director of the Racing Operation Council becomes the Chairman of the committee, and other members are appointed by the organizer, whenever a meeting of the committee is convened, as specified in Article 3-a.
- c. When the Director cannot perform his duties for unavoidable reasons, one of the members appointed by the organizer performs in his behalf.
- d. The manager in charge of the committee tasks becomes the Secretary who deals with the general affairs of the committee.
- e. The members of the committee must not reveal any secrets that are obtained during meetings of the committee.
- f. Despite the regulations in Article 3-a and 3-b, the chairman may appoint three more external members from sports, academic, and law societies(hereinafter referred to as «external members»). The external members may be paid.

Article 4 (Convention)

The Chairman may convene a meeting when he thinks it is necessary or over half of the members request that a meeting be held.

Article 5 (Decision-making)

- a. The committee may decide on matters, when over half of the members participate in the meeting and it gets approval from over two thirds of the participants. The Chairman also has a right to vote.
- b. The decisions made by the committee are put into action after getting approval from the President.

Article 6 (Agenda)

The agenda of the committee is as follows:

1. Matters related to the cancellation of registration in Article 16-b of the Hydro Sprint Management Regulations (see H.S.I. handbook)
2. Matters related to the suspension of participating in races in Article 21 of the Hydro Sprint Management Regulations (see H.S.I. handbook)
3. Matters in which a motorboat racing operator or a relevant director has asked for a sanction.
4. Matters related to the sanctions in Article 22-1 of the UIM Hydro Sprint Enforcement Regulations.
5. Matters related to applications for objections in Article 28 of the UIM Hydro Sprint Enforcement Regulations.
6. Other matters the committee considers necessary to discuss.

Article 7 (Participation of the Motorboat Driver Subjected to a Sanction)

- a. If the committee is to apply a sanction to a driver (including cancellation of registration in Article 6-1, the same applies hereafter), it must let the driver participate in the meeting and be given the chance to vindicate himself/herself, unless:
 1. the driver does not vindicate himself/herself within a certain period for some reason, including failure by the committee to notify him/her to participate in the meeting.
 2. the judge has deliberated and decided on a sanction.
 3. the driver is in prison for a violation of the Motorboat Racing Act.

4. the driver receives a sanction, pursuant to the sanction appreciation standards.
- b. If necessary, the Chairman may let relevant people participate in the meeting to give a statement.

CHAPTER 3. SANCTIONS

Article 8 (Application for Sanction and the Procedure Involved)

- a. If a motorboat racing operator or a relevant director considers it is necessary to impose a sanction on a driver, according to the provisions in Article 6, he must request the Secretary of the committee to give a sanction and submit factual data.
- b. The Secretary, who is notified of the reason for a sanction, according to the provision in Article 8-a, must check the matter and place it on the agenda of the committee, unless there are exceptional reasons.
- c. If there is an application for an objection, according to the provisions in Article 28 of the UIM Hydro Sprint Enforcement Regulations, the Secretary must directly bring the matter up for discussion, despite the provision in Article 8-b.
- d. If the Secretary takes up the matter for discussion, according to the provisions in Article 16-b and 16-c, he must notify the motorboat racing operator or the relevant director who requested the sanction of the result, according to the provision in Article 8-a.
- e. The motorboat racing operator or the relevant director may ask the driver to submit a written apology over the incident. In that case, he or she must submit the relevant documents to the Secretary. The Secretary must record and maintain a list of the people who have submitted written apologies, using Annex Form 1.
- f. The Secretary must ask the committee to impose a sanction on a person who has submitted a written apology more than three times a year, according to the provision in Article 8-e.

- g. If the Secretary does not have enough evidence or data to explain the reason for a sanction, when he or she takes up the matter for discussion, pursuant to the provisions in Article 8-b, 8-c, and 8-f, the Secretary may ask the person who requested the sanction to complement the relevant evidence or data needed to prove the reason.

Article 9 (Processing of a Sanction Procedure)

- a. As for the matter that is to be taken up for discussion or is being discussed by the committee, a sanction procedure must be put in motion, regardless of whether it is being examined by an investigation agency, or waiting for a legal hearing. However, the sanction procedure may be postponed if it is necessary to process the matter after referring to the result, to make a fair judgment.
- b. When a sanction needs to be discussed for a suspect about more than two matters, it must be subjected to a joint discussion.

Article 10 (Decision on a Sanction)

- a. The committee must decide on a sanction within 30 days of accepting the application for sanction deliberation.
- b. If the processing of the sanction procedure is suspended, according to the provision in Article 9-a, after a sanction is requested, the suspended period is not included in the decision-making period in Article 10-a.
- c. A sanction approval form must be signed by the participants, and a judgment on the factual data for the sanction and relevant provisions must be specified.
- d. The committee must notify the driver, who is to receive the sanction, of the sanction in Annex Form 2.
- e. If a driver is banned from participating in one race, pursuant to sanction appreciation standards, the committee may make a decision in written form.

Article 11 (Sanction Appreciation and Its Standards)

- a. The committee may decide on a sanction, considering the driver's previous violations of laws and regulations, intentionality, racing record, usual behavior, racing attitude, attacks, and possibility of improvement.
- b. The President may provide separate appreciation standards to ensure the fairness and consistency of sanctions.

Article 12 (Added Sanction)

The committee may apply an added sanction to a driver who commits the same wrongdoing within a year of receiving a sanction.

Article 13 (Reduced Sanction)

- a. The committee may reduce a sanction against a driver who meets the following conditions:
 1. The sanction may be reduced to a suspension of participating in races if a driver, who applies to the provisions in Articles 16-b-1, 16-b-6, and 16-b-7 of the Hydro Sprint Management Regulations (see H.S.I. Handbook), is considered to be regretting his/her wrongdoing.
 2. The sanction may be reduced to a suspension of participating in races if a driver, who applies to the provisions in Article 16-b-4 of the Motorboat Racing Management Regulations (see H.S.I. Handbook), is considered to be trying to improve his/her record.
 3. The sanction may be reduced to a written warning if a driver, who applies to any of the sections under Article 30 of the Hydro Sprint Management Regulations (see H.S.I. Handbook), is considered to be regretting his/her wrongdoing.
- b. The sanction may be reduced to a suspension of participating in races if a driver, who applies to Article 16-b-5 of the Hydro Sprint Management Regulations (see H.S.I. Handbook), is considered to be able to recover his/her racing capacity.

CHAPTER 4. LODGING AN APPEAL

Article 14 (Lodging an Appeal)

- a. If a person, who received a sanction from the committee, meets any of the following conditions, he or she may lodge an appeal:
 1. The person can prove that the reason for the sanction was beyond his/her control.
 2. There is concrete evidence proving that the original sanction needs to be reduced to a minor one.
 3. The sanction is considered too unfair or harsh.
- b. A person, who wants to lodge an appeal, must submit the application using Annex Form 3 to the Chairman of the committee, within 30 days of receiving the sanction.
- c. If a person who received a sanction lodges an appeal, the Chairman must review it, and if it is reasonable, the Chairman must promptly request the committee to deliberate on the case again.
- d. If the President recognizes that the decision of the committee has a severe, concrete fault or is unfair, he or she may request that they deliberate on the case again. If the committee decides to apply the same sanction, the sanction is confirmed.

Article 15 (Re-deliberation)

- a. When the committee receives an application for appeal, it must deliberate on the appeal again within 30 days unless there are special reasons.
- b. After deliberating on the case again, the committee cannot apply a harsher sanction than the original one, unless reasons for another sanction occur.
- c. The sanction after re-deliberation is retroactive to the original sanction date.
- d. If the committee decides to reduce or cancel the original sanction after re- deliberation, sanctions against other people, who are involved in the same case, may be reduced or cancelled.

- e. If the committee dismisses the request for re-deliberation or changes the decision on the sanction considering it to be reasonable, it must notify the person of the result.

Article 16 (Exclusion and Avoidance)

- a. If the Chairman or members of the committee have personal interests in the case, which is being discussed, they must not participate in the deliberation.
- b. If a person who is to receive a sanction has some reasons to worry that the Chairman or members of the committee may make an unfair decision, he or she may explain to them in writing and request that those individuals not be part of the deliberation process.
- c. If there is an application requesting that some individuals should be excluded from the deliberation process as specified in Article 16-b, the committee must discuss it and decide on whether the person's concerns are justified. In this case, the Chairman or members of the committee, who are the object of the request, cannot participate in the decision-making process.
- d. If the Chairman or members of the committee cannot perform their duties, pursuant to the provisions in Article 16-a or 16-c, they are not counted on the register roll.

Article 17 (Effects of the Original Sanction)

The original sanction is effective until a decision is made after deliberating on the case again, which is limited to one time. However, an additional deliberation may be conducted if the case applies to Article 14-a-2 or 14-d.

Article 18 (Decision on Repairs)

If a person involved in the case personally submits an application for cancellation of the driver's registration, repairs must be postponed until a decision is made on the case, and must comply with the result of the discussion.

ANNEXED TABLES

(Table 1)

The Members of the Racing Operation Council

Members	Duties in charge
President	1. Generalizing race operation 2. Controlling members of the Committee
Vice-president	1. Supporting President in running and operating races 2. Acting as a substitute when president's absence 3. Serving concurrently as a member of the Committee
Facility Managing Director	1. Managing and repairing all facilities
Judging Director	1. Deciphering and confirming start/finish, drivers' qualification 2. Announcing results of «1» 3. Operating and managing judging facilities 4. Judging Director may hold deputy judges in order to support its duties - Signal Judge, Central Judge, First Corner Judge, Second Corner Judge, Inspection & Start Judge, Finish Judge, Time Checker, Recorder
Fairness Controllers	1. Preserving discipline around the water stadium 2. Supervising visitors 3. Treating emergency such as a riot, fires, etc. 4. Scrutinizing fairness on races 5. Operating doping tests 6. Taking sanction to drivers
Racing Operator	1. Composing races and introducing the races 2. Executing an aptitude test for participating drivers 3. Managing and operating other facilities related
Ticket Sales Managing Director	1. Issuing and selling betting tickets 2. Calculating and granting dividends 3. Announcing the two above 4. Managing and operating Electronic Ticket Sales system 5. Managing civil appeals
Broadcasting Director	1. Broadcasting races
Betting Shop Managing Director	1. Managing betting shops
Driver & Motorboat managing Director	1. Managing and controlling drivers 2. Maintaining racing boats and other boats 3. Managing fuels
Administration Manager	1. Executing general affairs, accounts, etc 2. Managing human resources and environmental circumstance

(Table 2)

Medical Criteria for Participating Drivers

A doctor judges qualification of participants to a race according to the following criteria. Although a driver who isn't fit to the criteria, he/she may participate in a race as long as the driver is admitted to execute his/her racing ability.

Examinations	Criteria
Surgical Examination	1. No external wound causing other serious diseases 2. No aftereffect from past surgical operations 3. No bone damage or fracture, articular damage, causing disability and other diseases.
Internal Examination	No disease in internal organs
Ophthalmology Examination	No ophthalmologic disease causing disability
A nose, ear, and throat Examination	No nose, ear, and throat disease causing disability
Others	1. No infectious disease 2. No chronic disease 3. No high temperature and acute disease 4. No Other diseases causing disability on a race

(Table 3)

The Standards of Boats and Motors

Class	Boats		Motors	
Types and Standards	Type	Hydroplane boat	Type	Outboard motor (The aquatic propeller, which can be attached to the transom of the boat by a person, must be a suitable match for the internal-combustion engine.)
	Length	250~350cm	Engine type	2 cycles, 2 cylinders
	Width	122~150cm	Propeller type	Rotary propeller
	Weight	65~80kg	Cylinder capacity	350~500cc
	Essential equipment	1. Steering wheel and steering system 2. Cowling 3. Pin	Essential equipment	1. Automatic closing throttle 2. Ignition time manual controller (Timer device)
	Res-trictions	-	Res-trictions	1. There must be no supercharger or its equivalent. 2. The lower unit must not be a tractor type. 3. There must be no equipment used that promotes engine combustion, including an oxygen tank.

Boat Specifications

Applicant	Name			Address		
Boat name	As accepted by H.S.I. Ltd					
Kind	Hydroplane Boat					
Manufacturer	Name			Address		
					Prod. Date	
Total length	290cm	Max. Width	132cm	Max. Depth (Center)		32cm
Weight	76kg	Transom height		28Cm		
Coating characteristics	Urethane sealing and water-proof coating					
Main materials	(1) Shell 2) Frame (3) Deck					
Fixing method			Bottom type	Stair type		
Seat size	Length: 139Cm Width (front): 55Cm (Back): 35Cm		Pin		Number () None	
Others						

(Tips)

1. Digits after the decimal point must be omitted, when you fill in total length, maximum width, maximum depth (center), weight, and transom height.
2. You must fill in the colors of the bottom, sides, and deck for the coating characteristics.
3. You must fill in wood, light alloy, special steel, etc., for the main materials.
4. You must fill in the fixing materials, such as nails and glue, for the fixing method.
5. You must fill in stairs, flat, round, or V for the bottom type.
6. You must fill in special remarks about the boat in the space for others, if there are any.

(Annex Form 2)

Sanction Notice

Registration No.	Name
Sanction	
Relevant Law(s)	
Reason(s)	
Lodging an Appeal	If you object to the sanction, you may lodge an appeal within 30 days of receiving the sanction, pursuant to Article 14 of the operation rules of the Motorboat Racing Sanction Deliberation Committee.
<p>We notify you of a sanction.</p> <p>20.....</p> <p>The Chairman of the Motorboat Racing Sanction Deliberation Committee</p>	

(Annex Form 3)

Application for an Appeal	
<p>Address:</p> <p>Name:</p> <p>Date of Birth:</p>	
<p>The person stated above received a sanction from the Motorboat Racing Sanction Deliberation Committee on yyyy/mm/dd and lodges an appeal for the reason(s) specified in the annexed form, pursuant to Article 14 of the operation rules of the committee.</p> <p>20</p>	
Applicant	Signature
<p>Attached documents: 1. A copy of the driver registration 2. A copy of the notice of a sanction 3. A letter of the reasons for the appeal</p>	
<p>The Chairman of the Motorboat Racing Sanction Deliberation Committee</p>	



Acknowledgment and Agreement

I, as a member of [National Authority] and/or a participant in a [National Authority or U.I.M.] authorized or recognized event, hereby acknowledge and agree as follows:

1. I have received and had an opportunity to review the [U.I.M.] Anti-Doping Rules.
2. I consent and agree to comply with and be bound by all of the provisions of the [U.I.M.] Anti-Doping Rules, including but not limited to, all amendments to the Anti-Doping Rules and all International Standards incorporated in the Anti-Doping Rules.
3. I acknowledge and agree that National Authorities and the U.I.M. have jurisdiction to impose sanctions as provided in the U.I.M. Anti-Doping Rules.
4. I also acknowledge and agree that any dispute arising out of a decision made pursuant to the U.I.M. Anti-Doping Rules, after exhaustion of the process expressly provided for in the U.I.M. Anti-Doping Rules, may be appealed finally as provided in Article 13 of the U.I.M. Anti-Doping Rules to an appellate body for final and binding arbitration, which in the case of International-Level Drivers is the Court of Arbitration for Sport.
5. I acknowledge and agree that the decisions of the arbitral appellate body referenced above shall be final and enforceable, and that I will not bring any claim, arbitration, lawsuit or litigation in any other court or tribunal.
6. I have read and understand this Acknowledgement and Agreement.

Date Print Name (Last Name, First Name)

Date of Birth

(Day/Month/Year) Signature (or, if a minor, signature of legal guardian)

A

Absence of race number	206.03
Advance-programme	202
Aerial (boats with aerial propeller)	590
Age limit	203.04
Aid (first aid station)	205.08.02
Altering course	312.12
APBA recognised series	106.01
Appeal (court)	405.01
Appeals (protests and)	403/405
Approaches to the starting line	306.08
Authority (change of National)	120.02
Awarding of prizes	322

B

Base	300-604
Before the start	306.06
Boat starting before time	306.09
Boats (inflatable)	560
Boats (equipment)	503
Boats (fouling competing boats)	314
Boucquey Trophy	803
Buoy and course officers	201.07
Buysse Trophy	801

C

Calculation of speed	605
Calendar	101
Cancellation of licence	120
Cancelled (race)	308
Cards (yellow)	406.03
Certificate (record)	615.08
Certificate (measurement)	501
Certificates (performance)	614
Championship (world)	107
Championships (continental)	108
Championships (general rules)	106
Change of date	101.04
Change of National Authority	120.02
Circuit	302
Circuit races (rules for)	300
Circulation of the result (record)	615.07
Classes (international series and classes)	500
Classes, sports outboards	540
Classes racing inboards	510-515
Classes eligible for records	601
Classes racing outboards	520
Classes (monohull, outboards)	550
Classes Sport outboard	530
Classes Osy 400	525
Classes Pneumatic	565
Classes Diesel	570

Classes Turbo Sets	580
Classes Aerial Propellers	590
Classes Electric Powered Boats	595
Classes Inflatable	560
Clock	306
Cockpit (reinforced)	509
Clothing protection	205.11
Commissioner (U.I.M.)	102
Committee (powers of the race)	201.01
Committee (organising, race)	201.01
Cost of measurement	501.01
Course (marks of the)	303
Cups (international)	800

D

Date (change of)	101.04
Deadline dates	101.03
Dead engine start	307
Dead-Heat	319
Deformable pickle-forks	503.02
Deputy Officer of the Day	201.04
Discs	306.02
Disqualification	406.04
Distinctive marks	206
Drag racing	112
Doping test	205.02.02
Duties of the timekeepers	201.09
Duties of the Technical officers	201.07

Duties of the race Officials	201.06
Duty of the Deputy officer of the day	201.04

E

Electric powered boats	595
Endurance races	109-902
Entries	203
Entry level racing classes	500.04
Environmental care	704
Equipment of boats	503
Exclusion	406.07

F

Fee (entry fee)	203.03
Finishing line	318
Finishing a race	317
First aid station	205.08.02
Flag signals	304.02
Fouling marks	313
Formula Future rules	500.10
Fuel	508-514-519-524-529-534-544-554-564-569-574-584-594

G

Gun	306.03
-----	--------

H

Handicap	111
Heats (races in several)	318.01
Helmet	205.07
Homologation of records	615
Homologation of engines	505
Homologation sheets	505.11-505.12-505.13
Hulls (inspection of)	321-607
Hydro Sprint racing rules	904

I

Immersion Test	205.05
Inspection of engines & hulls	321-502-607
Insurance	205.09
Interested parties	402.02
International races recognised by the U.I.M.	103-104
International series and classes	500
International cups	800
International officers	201.02
Interpretation of the rules	200.02

J

John Ward Trophy	802
Jet Sprint Rules	901
Jurisdiction	400

Jury	201.01-402
John Hill Trophy	805

L

Licences	120
Life jacket	205.06-509.04
Lifting of race boats	205.12
Log book	501.11
Low emission engines	541.02-542.12-566.01

M

Margin required (records)	606
Marks of the course (definition)	303
Marks of nationality	206
Marks (rounding)	312.11
Match race	307.10
Measurement certificate	501
Medical examination	205.01, 02, 03, 04
Medical Officer	201.04.01
Minimum age	203.04
Modifications allowed	528.10-533.10-543.10-553.10 562.10-563.10-568.12-528.10-568.10
Motor shut off switch	509.12

N

National Authority (change of)	120.02
--------------------------------	--------

Nationality of the drivers	203.05, 206.01
Noise reduction	504
Non approved races	104
Number and value of the prizes	322
Number (race)	206.02

O

Obstacle (definition)	300.01
Officer of the Day	201.03
Organisation of records	600
Organisation of races	200
Organising committee	201
Overlap, overtaking	312.02-08

P

Passing marks	312.11
Penalties	406
Performance certificates	614
Piston motors	503.07
Pickle-forks	509.02
Posting of the results	320
Postponed (race)	309
Prizes (number and value)	322
Production changes (engines)	505.14
Programme (race)	204
Protection (technical)	205.10
Protests	403

Protests (and appeals)	405
Pseudonym	120.07
Publicity	203.051

R

Racing instructions	204
Race number	206.02
Race (stopping of a)	311
Race cancelled	308
Race postponed	309
Race shortened	310
Race (finishing a)	317
Races (rules for circuit)	300
Races recognised by the U.I.M.	103
Races in several heats	318.01
Racing licences (rules)	120
Records	600
Record certificate	615.08
Record (circulation of the result of a)	615.07
Report of the Commissioner	102.04
Reports	323
Result (circulation of the result of a record)	605.07
Results (position of the)	320
River Marathon Rules	900
Rotary motors	503.07
Rounding marks	313
Rules of the road	312
Rules (interpretation of the)	200.02

S

Safety zone	306.05
Safety of the driver	205
Safety boats	205.08
Scoring system	318
Signals from the shore	304
Signals (starting)	304.02
Start (flying)	306
Start (dead engine)	307
Start	305
Starting (boat starting before time)	306.09
Starting in groups	304.03
Starting line (approaches to)	306.08
Stopping of a race	311
Super charging	503.09
Super-licence	120.08
Suspension	406.05

T

Technical officers	201.07
Technical protection	205.10
Throttle cut-off device (automatic) ⁵	03.03
Timekeepers and timing devices	201.09-301
Timing	301
Titled International events	105
Towing boats	205.08.01
Trophies	800

NOTES

U.I.M. FORMULA 1 WORLD CHAMPIONSHIP

1. ORGANISATION
2. RACE FORMAT
3. START
4. STOPPED RACE
5. INTERRUPTED RACE
6. RACE COURSE
7. CLASSIFICATION
8. EQUIPMENT
9. FUEL
10. SUPERLICENCES
11. YELLOW CARDS
12. PROCEDURE FOR PROTESTS AND APPEAL
13. SAFETY
14. GENERAL

INTERPRETATION OF THE RULES - 200.02

In all cases unforeseen by the international rules, the National Authority is to adjudicate, bearing in mind the spirit of the rules.

In the case of conflicting rules, these rules concerning the Championship as published in the blue pages of the Circuit Rules Handbook, shall prevail.

1. ORGANISATION

- 1.1. The rights of organisation of Formula 1 races and championships are owned and ruled by the U.I.M. which has granted the management of the competition to the Council.
- 1.2. The Council may update these rules whenever necessary.
- 1.3. The Formula 1 daily Management Committee is responsible for the championship daily management.

The Formula 1 World Championship is governed solely by the U.I.M. international rules for circuit racing, as published in the white and blue pages of the Circuit Rules Handbook.
- 1.4. The permanent Formula 1 U.I.M. commissioner must check new venues in due time before an event can be sanctioned.

As well as the permanent Formula 1 U.I.M. commissioner, a technical commissioner must be appointed for each race. Both commissioners are members of the Formula 1 management committee.
- 1.5. A Formula 1 Protest Judge will be nominated for each event and will adjudicate on all protests.

The protest judge must be named in the advance programme.
- 1.6. The Officer of the Day must speak fluent English.

The following officials have to be Club, NA or U.I.M. officials:- OOD, deputy OOD, safety officer, technical officer/scrutineer, time keeper, pit marshal; pontoon marshal and starter.
- 1.7. It is strictly not permitted to grant club-membership for the duration of the race meeting to interested outside parties.
- 1.8. The U.I.M. flag must be flown from a prominent position at each event.

2. RACE FORMAT

- 2.1. Each Formula 1 meeting counting towards the drivers World Championship will take place over a period of two or three days in accordance with the full U.I.M. Circuit Rules for racing, classification, protests and appeals and the specific rules listed below.

Friday	12.00 - 13.00 hrs 12.00 hours	Documentation and registration Technical scrutineering Boats and all racing equipment (including racing gear of the driver) must be in the pits at 12.00 hours (fine if not present)
Saturday	09.00 hours 10.00-11.00 hrs 13.00-13.45 hrs 15.00-15.45 hrs 16.30-17.00 hrs	Drivers' meeting (compulsory for drivers and radiomen and team managers of each boat) at race headquarters (fine if not present at the roll call) Free practice First timed trials Each boat entitled to only 15 laps excluding their first lap. Second timed trials Each boat entitled to only 15 laps excluding their first lap. Timed trials for the 6 fastest boats
Sunday	09.30 hours 10.15-11.00 hrs	Drivers' meeting (compulsory for drivers and radiomen and team managers of each boat) at race headquarters (fine if not present at the roll call) Free practice

14.30 hours Formula 1 Race (approx. 45 minutes duration, but with a limit of 90 minutes including any re-starts)

If there is a change to the racing course layout, there may be extra free practice.

- 2.2. No entry shall be considered official until the boat has passed scrutineering and the documents are checked.

Only one boat per driver is allowed to be entered for any championship meeting. Spare hulls and engines are allowed but may be used only as foreseen in the Formula 1 rules.

- 2.3. If force majeure causes one of the two time trial sessions to be cancelled the results of the other session will still stand. In the event that less than 50% of the other session is run, then the grid positions will be established using the current championship positions.

- 2.4. Each boat is allowed to pass the timing control a maximum of 15 times during each time trial session.

- 2.5. Establishment of start-grid positions from timed trials.

2.5.1. All drivers must participate in both timed trials.

2.5.2. Each driver's start-grid overall position will be based on the fastest time from both timed trials.

2.5.3. If force majeure causes one of the two time trial sessions to be cancelled, the result of the other session will stand. In the event that less than 50 % of the other session is run, then the grid positions will be established using the current championship positions.

2.5.4. The starting grid positions for the six fastest boats from timed trials will be further adjusted by taking the order of best times achieved in a subsequent shoot-out session. The previous results of the timed trials will no longer be valid.

2.5.5. If an officially declared force majeure or a driver decision prevents a driver from participating in the shoot out, he will automatically take the last of the first six positions in the starting grid. In the case of more than one driver being so affected, they will be positioned relative to each other in accordance with their timed trials times.

2.5.6. The six fastest engines in time trials must be sealed, the boats weighed, their fuel checked, and, if so equipped, their restricted induction system integrity checked. A procedure of random weighing and fuel testing during timed trials will also be enforced.

2.5.7. Any engine changed after qualifying time trials or the shoot-out, will be sealed by the U.I.M. technical commissioner and will be checked for legality.

- 2.6. The official practice schedule will be posted at race control.

Testing outside the race circuit and before or after authorised hours is prohibited during the event.

- 2.7. In case of force majeure, this format may be amended by the OOD and the two commissioners.

If a race is shortened due to force majeure, it is at the discretion of the OOD and the U.I.M. commissioner to alter the time table, and if necessary the course layout accordingly.

If the race is declared to be on rough water, the number of laps should ideally be maintained, but may be reduced if seen fit by the U.I.M. permanent Commissioner. If time permits, the circuit layout can be changed, as agreed by the permanent commissioner and the drivers representative.

- 2.8. If they change boat for rough water conditions, they take last position on the pole grid.

QUALIFICATION PROCEDURE

2.9. The maximum number of boats will be 24 for the race, unless decided differently by the U.I.M. Permanent Commissioner and the Promoter, and announced at the first drivers meeting.

If more boats are entered for a race, the series contracted boats will automatically have access to the official practice and time trials. All other boats will participate in a 30 minutes pre-qualifying timed practice session which will take place on Saturday morning one hour before free practice; the fastest boats will be allowed to participate in the official practice and time trials, bringing the numbers up to the maximum of 24. If necessary, the non-qualified boats must leave the paddock area.

2.10. The U.I.M. Commissioner reserves the right to place one non-qualified boat in the final event. National drivers from the country hosting the event or a driver selected by the promoter will be eligible. The wild card driver will be announced at the first drivers' meeting.

2.11. On the afternoon before the race, a meeting must be held to examine the main points of the race. The attendees of the meeting, and the agenda, must be in accordance with the rules of the U.I.M.

2.12. The U.I.M. Commissioner must ensure that there is a roll-call of names of drivers, radiomen and team managers and each one must respond with his assigned racing number. If the driver is not present to respond when his name is called, a financial penalty will be imposed.

3. START

3.1. The start shall be a dead-engine jetty start as described in rule 307, bearing in mind the following

- To increase the length of the pontoon to come close to 5 metres space per boat. This would leave more space to maintain the lanes.

- To incline the pontoon (or change the location of the first buoy) sufficiently not to have the pontoon straight on the first buoy.

In case these points are not feasible, the alternative will be a rolling start upon decision of the U.I.M. Commissioners. Also the Commissioners will apply stronger penalties for drivers not maintaining their lane.

3.2. Boats should be drawn up with dead engine, stern first to a jetty, floating pontoon, or beach.

Boat which do not line up with the boat next to them within 20 seconds of being requested to do so will be penalised financially.

3.3. The distance between the starting line and the first turning buoy must be at least 300 m considering all safety aspects.

3.4. When the Pontoon Marshal is satisfied that all drivers are ready to start, with engines stopped, he will raise a green flag and the OOD will initiate the start procedure, by instructing the starter to raise the 30 seconds board (min. 80 x 80 cm, figures 60 x 10 cm).

Once the 30 seconds board has been raised those drivers starting their engines or leaving the pontoon before all red lights are switched off, will be penalised one lap. This lap will be deducted at the end of the race.

30 seconds after this board is raised all red lights will be switched on. Between 5-15 seconds after that, all red lights will be switched off and the race starts.

After a period of time the red light will be shown again.

3.5. Late starters: A driver who has failed to start before the red light is shown again, must wait until the whole field has passed the start pontoon before he may join the race through the entrance lane to the course.

3.6. The starter may decide, if he judges it necessary, to cancel the start by showing the red flag and recommence the starting procedure.

- 3.7. The start jetty or pontoon must be minimum 75 m long or be equal to 5 metres multiplied by the maximum number of boats permitted to race, (whichever is the greater) and must be at least 1.5m wide.

The alignment of the start pontoons must be such that the pole position has the maximum advantage towards the first turn buoy, compared with the last positions on the starting grid. The plan of the circuit (including the position of the start pontoon) must be sent to the U.I.M. office 60 days in advance of the race date for approval of the permanent commissioner.

- 3.8. Any boat not starting must be returned to shore by the driver's own efforts. Any crew member swimming out to a boat will cause his entry to be disqualified.

Only uniformed crew who are Formula 1 team members with Formula 1 passes designating pit starting pontoon admittance will be allowed on the starting pontoon.

- 3.9 The start procedure may be changed in 2005 in order to separate the boats in two groups from the start until the first buoy by guiding the drivers through 2 different gates marked with 2 large buoys ahead of the first turn buoy. The daily management committee will decide whether to apply this system in 2005 and full details on the starting system will be given at the drivers briefing.

- 3.10 An overlap is established only when two boats are on the same course, or approximately the same course, and the cockpit of the overtaking boat, if overtaking from the inside, is even with the cockpit of the overtaken boat. When overtaking from the outside, an overlap is established when the overtaking boat has passed the overtaken boat sufficiently to change lanes without contact. The following rules shall apply to an overlap :

- The lead boat has the right of way until an overlap is established.
- A safe overlap is the responsibility of the overtaking boat

- Once an overlap is established, the overtaken boat must give the overtaking boat room to clear any course markers.
- The overtaking boat cannot force an overlap after the lead boat has begun to alter course to negotiate a turn.
- An overlap can occur from port or starboard.

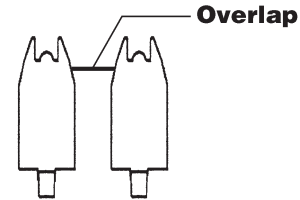

4. STOPPED RACE

- 4.1. In the event of the race being stopped, boats must return under their own power to the start pontoon [or other position on the circuit notified by the U.I.M. Commissioner during drivers' briefing]. Alternatively, the yellow flag may be shown and all drivers will continue at slow speed with no overtaking.
- 4.2. Drivers receiving outside assistance at any point during the race (whether the race has been stopped for an incident or not) will be disqualified.
- 4.3. Boats that have broken down and received outside assistance by being pulled to the infield or off the race course will be towed to the launching pontoon only during a «race stop» condition and if pick-up boats are available.
- 4.4. Repair or maintenance work may only be carried out on boats that have returned to the launch or start pontoons under their own power. Repaired boats may rejoin the race at any time as

- directed by the pontoon Marshal. Further definition of the repair areas will be given at drivers briefing.
- 4.5. No repairs are allowed on the start pontoon during the line-up and start or re-start procedure.
 - 4.6. Drivers may carry-out their own repairs on their boats in accordance with the rules. The driver's two nominated pontoon mechanics and the official crane driver do not count as outside assistance.
 - 4.7. In the event of a restart, a boat being repaired must be ready to take its position on the grid as directed by the pontoon Marshal. If the boat is not ready to take its position, it must start at the end of the pontoon.
 - 4.8. The re-started race distance will be the original race distance minus the total number of laps completed by the leading boat at the time of the stoppage, minus also 1 lap per re-start.
 - 4.9. Starting positions for restarts, or final classification if there is no restart, will be determined by the order at the end of the lap prior to the race being stopped.
 - 4.10. The race organiser may at any time determine who was responsible for a race stoppage, even after the race is finished; in which case the guilty driver[s] will be disqualified from that race.
 - 4.11. It is mandatory that all boats have remote controlled red and yellow lights in their cockpit. It is the drivers' responsibility to ensure that these lights are functioning and that they are clearly visible to the driver whilst racing.
 - 4.12. In case of a race stop, the rescue boats and race control will show the red flag and race control will switch on the red light in the boats.
At this signal all drivers must immediately slow down and return to the starting pontoon, or the previously defined re-start area.

- 4.13. The decision and procedure to have restart from pontoon or from milling area will be announced at the drivers' briefing.

5. INTERRUPTED RACE

- 5.1. The position of the boats for the restart will be that of their passing order on the lap before the yellow signal was given. Boats which do not restart in their correct position, will be given a one lap penalty.
- 5.2. When the yellow flag is shown, the leading boat or a designated boat will act as pace boat, and run at slow speed. The yellow flag will be used by race control and the rescue boats to indicate a hazard when displayed stationary, and extreme caution to be exercised by drivers when waved vigorously.
- 5.3. The Organiser may interrupt the race for any reasons of safety or emergency services access, and in which case the rescue boats and race control will show yellow flags and race control will switch on the yellow lights in the boats.
At this signal all drivers must immediately slow down and not overtake. Any overtaking, 5 seconds after the yellow signal has been given, will be penalised by 1 lap unless instructed by the OOD or UIM Commissioner to change position of the rolling restart.
- 5.4. When the race course is clear, only the yellow flag at race control will be continued to be shown.
- 5.5. All boats maintain their position at slow speed (approx 4000 rpm) until race control raises the green flag. It is the responsibility of the team managers to ensure that their boat(s) are at the correct position at the restart.
- 5.6. When a rolling re-start is used the U.I.M. Commissioner can show the green flag if the first 10 boats are in their correct positions. Boats which do not restart in their correct position, will be given a one lap penalty.

- 5.7. During the yellow signal situation, a boat may leave the race course but must re-join the race behind the boat running in last position.
- 5.8. The OOD or UIM commissioner may – up till one hour after posting of the results, determine who was responsible for an interrupted or stopped race, even after the race is finished ; in which case the guilty driver(s) will be disqualified from that race.

6. RACE COURSE

- 6.1. The length of the straight between any 2 turning buoys is to be a maximum of 850 metres.
- 6.2. There must be a minimum of 2 cranes for launching boats.
- 6.3. The boundaries of the water on which practice and racing are allowed to take place must be defined in the advance-programme.
- 6.4. The pit area should be sufficiently large to prevent boats being craned into the water over other boats.
- 6.5. Safety rules shall be those of the U.I.M. applicable on the date of the race unless specified otherwise by these rules.
- 6.6. Right hand turns can be inserted on the race course.
In order to avoid any confusion, left hand turns will be marked by orange buoys and right hand turns by yellow buoys.

7. CLASSIFICATION

- 7.1. The boat placed first will be the one having covered the scheduled distance in the shortest time.
- 7.2. All boats will be classified by taking into account the number of complete laps that they have covered and for those which have completed the same number of laps, the order in which they crossed the finish line.

- 7.3. The number of laps completed during restarts will be taken in account for the classification.
- 7.4. Points will be awarded to the first 10 classified drivers on the condition that they have completed at least 70 % of the number of laps covered by the winner (rounded up or down in a mathematical way e.g. $18.5 + = 19$ and $18.49 = 18$)
- 7.5. Boats that complete 90% or more of the race distance, but do not cross the finishing line after the winner has crossed the finishing line, will be classified after those boats that have done the same number of laps but that also cross the finishing line after the winner.
- 7.6. To be awarded full points, the leading boat must have completed 70 % of the number of laps counting for the race.
- 7.7. If a stopped race cannot be restarted due to «Force Majeure», points will be awarded in accordance with the following scale:

70% or more of the total race completed	Full points
less than 70 % completed	Half points
less than 35% completed	No points
- 7.8. Finishing points scale:

First	20 points
Second	15 points
Third	12 points
Fourth	9 points
Fifth	7 points
Sixth	5 points
Seventh	4 points
Eight	3 points
Ninth	2 points
Tenth	1 point
- 7.9. The overall classification for the Formula 1 Drivers' World Championship shall be established by the addition of all points obtained by each driver in each of the races counting towards the championship.

The points are personal and are not allocated to the team. Each driver scores his own Championship points. If a driver changes team during the course of the season, he keeps his points.

- 7.10. In the case of a tie, the number of first places in these races shall be considered, then the second places, etc..
- 7.11. Immediately after the race:
The winner will complete a lap of honour
- 7.12. Presentation of trophies to first 3 drivers on the official podium. This presentation is only based on a provisional classification, and is subject to confirmation after scrutineering and consideration of any protests or appeals.
- 7.13. At the last race of the series U.I.M. will provide 3 medals (gold, silver, bronze) to be given to the first three in the overall classification of the World Championship.
These medals do not replace the normal prizes (art. 108.01 and 322).
- 7.14. Using the points scoring scale of the U.I.M. Formula 1 World Championship, a pole position classification will be established.
- 7.15. A Hull constructor's classification will be established where only the best place per brand will score points.
- 7.16. An engine constructor's classification will be established where only the best place per brand will score points.
- 7.18. The «John Hill Memorial Trophy» will be attributed at one of the Formula 1 World Championship rounds as decided by the Formula 1 Committee.

8. EQUIPMENT

HULL

- 8.1. The hull is free for each of the three capacities but must conform to the Formula 1 rules.
- 8.2. Hull, sponsons, and powerhead replacements and other parts are allowed after scrutineering, up until the start of the race, but any changes to be made must be immediately notified to the U.I.M. technical Commissioner for re-scrutineering and sealing and technical inspection of units removed.
- 8.3. Any replacement of boat or sponsons after qualifying time trials will result in all previous times achieved being cancelled, and the replacement boat or sponsons will be considered as a new entry, requiring full scrutineering. If no timed practice opportunity remains, the boat will start from the end of the grid.
- 8.4. Repairs are allowed at any time during the race weekend with the exception that the replacement of hull, sponson, crankcase, or cylinder block, is not permitted after the start of the race. Repairs are not allowed on the race course using outside assistance.
- 8.5. All craft must have an isolation switch as close to the positive terminal of the battery(ies) as practicable (negative terminal if positive earth system is employed).
The operating handle of the switch must be easily accessible on the deck or other surface of the boat on the port side between 1 to 3 meters forward of the stern.
This switch must be marked with a red flash + and the ON/OFF positions shown.
- 8.6. The weight of the boat, including residual fuel and oil, the driver with personal equipment, but excluding loose water is-
- | | |
|------------|-------------------|
| 2.0 litres | 486 kilogrammes * |
| 2.5 litres | 550 kilogrammes * |
| 3.0 litres | 586 kilogrammes * |

* The crash safety boxes will add 25 kilos to the boat weight and therefore the boat weight has been increased with 25 kilos for all boats.

The first six classified boats will be weighed with scales after time trials and the race. The weighing of the boats cannot be protested. The scales will be available before the meeting commences.

Upon request of the U.I.M. Commissioner, drivers must allow to be weighed separately.

- 8.7. The minimum length (measured along the sponson) is 4m80 for all three capacities
- 8.9. Radios in boats are mandatory and a full radio check of each boat will be part of technical scrutineering in order to guarantee that all radios are working. The radioman must be present at race control whenever his boat is on the course. In order to guarantee clear communication between the Team Managers and the U.I.M. Commissioner, all Team Managers must speak English.
- 8.10. Each wing mirror must have minimum size of 60 sq. cm and be bolted on 2 points to assure proper mounting.

Within one team, two identical boats must have different colours of mirror bodies as follows:

Odd number: yellow fluorescent colour

Even number: orange fluorescent colour.

- 8.11. Mooring eyes must be placed on the back of each sponson no more than 20 cm in from the outside of the sponson -see drawing

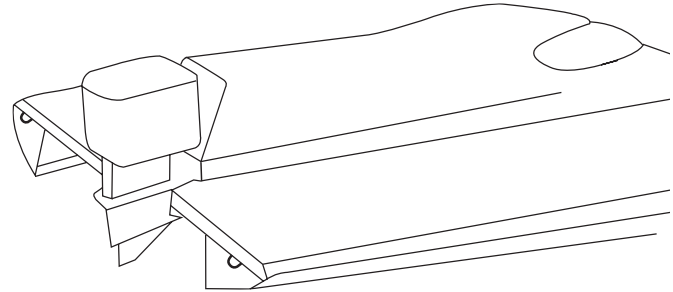

ENGINES

TECHNICAL RULES UNTIL 2009

ENGINES

1. A grandfather rule applies for all Formula 1 outboards that were homologated and eligible to compete up to and including the 2003 season. These engines are :
2. Mercury 2.5 EFI Homologation sheet No: F-1/00496
3. Johnson 3.0 EFI Homologation sheet No: F-1/00497
4. These engines will continue to be eligible for as long as they are competitive; they will be governed by their original homologation sheets supplied when new. These grandfather units will be taken as the performance benchmark for newcomers, with an objective of a nominal 350 hp performance ceiling. Modification of the OEM mapping in the Electronic Control Unit is permitted. Hardware changes are not permitted.
5. Any four stroke engine being submitted for homologation under these rules will have its performance limited by means of an orifice plate, 36mm bore diameter with a parallel length of at least 5mm. This plate may be incorporated into an airflowed induction

- system for atmospheric induction engines, and immediately prior to the compressor on forced induction engines; as designed and integrated by the manufacturer, and approved by the UIM management committee. The restrictor element will be a single metallic piece as detailed on UIM drawing number F1 – 001.
6. Any new two stroke engines submitted for homologation under these rules will have an induction restrictor that will be of a different diameter from the four stroke one, to compensate for the different combustion cycles.
 7. Except for the grandfathered engines, air can only be admitted to the engine for combustion via the restrictor orifice.
 8. The Formula 1 management committee reserves the right to review four stroke or new two stroke engine performance at mid-season in the event that one or the other is too performant within the meaning of these rules. If deemed appropriate, they will modify the diameter of the engine's induction restrictor. A four week grace period will be allowed for modifying and fitting the restrictor plates, from the date of announcement of the change.
 9. These technical specification for Formula 1 racing engines permit the engine [comprising of the power-unit, drive-line, propshaft, mounting system, steering, hydraulic, and electrical controls], to be installed as an outboard, inboard, or inboard / outboard, in any drive configuration. Lower units converted to single drive-shafts are permitted.
 10. New manufacturers are admitted provided they are prepared to make complete engine units available and sell them in any quantity on demand. Orders by teams must be placed and deposit paid by the end of June in any particular year, and delivery must be made by the end of December the same year. The maximum retail price for a complete engine unit is to be in the order of US\$ 75,000 and will be reviewed for approval by the Formula 1 management committee at time of homologation.
 11. Formula 1 boats must be water propeller driven, no airscrews are permitted.

12. Formula 1 engines must have a fixed ratio direct drive. Variable ratio gearboxes, friction clutches, and torque multipliers are not permitted.
13. Atmospheric induction engines with a maximum of 8 cylinders, will be admitted up to 3.0 litres nominal capacity; grouped into the following measured engine capacity ranges :

2.0 litre	measured capacity 1950 to 2100cc
2.5 litre	measured capacity 2101 to 2550cc
3.0 litre	measured capacity 2551 to 3100cc
14. Forced induction engines with a maximum of 6 cylinders will be accepted with an equivalent capacity calculated by multiplying the measured capacity by 1.4. The maximum measured engine capacity admitted will be nominally 2 litres, hence:

2.0 litre	measured capacity 1200 to 1500cc equivalent to 2100cc
2.5 litre	measured capacity 1501 to 1821cc equivalent to 2550cc
3.0 litre	measured capacity 1822 to 2100cc equivalent to 2940cc
15. Power units may be of any internal combustion design, of limited or series production.
16. Rotary motors will be rated in accordance with rule 503.08.
17. Diesel, external combustion, or gas turbine engines are not eligible.
18. Only single crankshaft/powerhead configuration is permitted.
19. 'Green engines' are to be encouraged [with respect to emissions] through incentives determined from time to time by the Formula 1 committee.
20. Engines must be capable of being silenced. If a particular race organiser requests it for local reasons, rule 504 will be applied and engines must not exceed a maximum decibel rating of 98 +6 db(A) when measured as rule 504.03.

21. If silencers are required to conform to the maximum noise rating, it is mandatory to have them available at all races. Compliance is required for scrutineering clearance.
22. To reduce environmental pollution, running-in of engines at the launch jetty or other specified area, will only be permitted by the Technical Commissioner and, if required by the Technical Commissioner, effective mufflers must be used
23. Non-compliance with noise regulations will be financially penalised.
24. All new Formula 1 engines must be homologated by the UIM in accordance with rules 505 and 506, and will be subject to these rules. Technical or component restrictions, mandatory in the UIM rules and homologation form, will apply to all engines as raced. For all engines, the crankcase and cylinder block, cylinder heads, induction system, injection system, engine management control unit including the ignition system, must be Original Equipment, corresponding with dimensions and/or part numbers on the homologation form.
25. Crankcase cover and exhaust tuner pipes for two stroke engines will be included in the homologated details.
26. Four stroke engine valve trains including cams, valves and mechanisms must be homologated, together with any supercharger and drives, or turbo blower and wastegate settings.
27. Engines will either be tested for induction system integrity by running them at a steady 4000 rpm and timing the period they take to stop when the induction restrictor is blocked by a spherical plug; or by means of UIM approved alternative instruments.
28. Non homologated OEM parts, or those parts not restricted by these rules may be changed for any after-market parts during engine race-preparation, but may not be included in the engine name unless the homologated engine manufacturer is specifically in agreement.

29. New engines will be accepted for homologation provided the engine/drive units are submitted for verification, the spirit and letter of the performance target of these rules is respected, and they are freely available to be purchased at a price approved by the Formula 1 committee.
30. To qualify for homologation, the manufacturer must present a complete power-unit assembly for verification by the UIM technical officer or delegate nominated by the Formula 1 daily management committee. All driveline and mounting units must be manufactured by the power-unit manufacturer, unless satisfactory proof of contractual agreement can be provided for mixed units, in which case both manufacturers names are to be included in the engine name and on the engine cover logo. Third paragraph of rule 505.01 does not apply.
31. Applications for homologation of a new engine, which will include a fully completed homologation form with recognition photographs, must be submitted no later than October 15th of the year preceding the first season of use. UIM verification and approval will be completed no later than 6 weeks after receipt of the application.
32. Manufacturer's logos and colour schemes must be used as homologated.
33. Running production changes will be accepted only once per year for the crankcase / cylinder assemblies, and notification must be received by October 15th of each year. Running production changes for all other components may be submitted for approval at any time. Legality for use will be considered by the Formula 1 committee, taking into account any affect the change will have on performance. If accepted, changes will be effective immediately after approval, and will be conditional that the affected components are freely available at a reasonable price. All interested parties will be notified by UIM.
34. In the case of an engine proving to be illegal, penalties will be imposed in accordance with rule 406 - Penalties

POST-RACE SCRUTINEERING

1. The measurements registered on the homologation sheet will be used as a reference for technical verification of the engine's legality. All dimensions given are absolute maxima [or minima, as the case applies] and no tolerance is given. The Original Equipment Manufacturer will build engines that are within the dimensions and conform to the homologation. The absolute responsibility will be passed onto the driver, at time of sale, to ensure that the engine maintains its legality irrespective of whatever maintenance or setting-up work is carried-out on it. Technical scrutineering will be carried-out using manufacturer produced gauges handed over at time of homologation to the U.I.M. These gauges will be used on a 'GO', 'NO-GO' basis. If the gauge does not go the dimension is legal.
2. The technical commissioner at each event will decide the degree of dismantling for inspection to be carried-out on the first three classified entries, and his decision will be final.

9. FUEL

- 9.1. An official fuel will be supplied by the Promoter / organiser at each race venue.

It will be of a continuously consistent specification and quality ; conforming to the data sheet and samples issued at the beginning of the season and agreed between the U.I.M., the Promoter and the Engine Manufacturers.

Only this fuel will be used; teams bringing their own fuel to the race venues will be penalised.
- 9.2. Fuel samples taken at random from competitors during the event will be tested at the race venue and may also be analysed afterwards at a laboratory.

Drivers disqualified for fuel infringements will have to pay all laboratory testing and analysis costs.

- 9.3. The only permitted addition to the fuel is lubricating oil for two stroke motors. The use of additives aimed at increasing the power of the motor is prohibited to either the fuel (carburant) or the air intake (comburant).
- 9.4. No chemical starter aids are permitted on the start pontoon.
- 9.5. All participants are subject to thorough inspection at any time. The entire fuel system may be disassembled, removed from the boat and inspected and/or fuel samples taken. The presence of illegal fuel, at any time, on the onboard fuel system will result in immediate disqualification from that part of the race.

The legality of the fuel is to be adjudicated solely by the U.I.M. commissioner, based on all tests and information available to him.
- 9.6. No refuelling will be allowed when the boat is not on its trailer.

10. SUPERLICENCES

- 10.1 A super licence is required for Formula 1 together with the NA international licence. No other membership is required.
- 10.2 A driver who exceeds 50 years of age in the season for which he is applying for a Superlicence, must produce two satisfactory medical certificates ; one from his own personal doctor, and the other from a doctor approved by the UIM.
- 10.3. The nationality of a driver is the nationality of the N.A. which issued the international racing licence to the driver. Medical and immersion tests can be done in other countries if the issuing N.A. agrees. The flag is the one of the issuing N.A. of the international licence as above. The request for the U.I.M. Superlicence must come from the N.A. which issues the international racing licence.
- 10.4. Drivers must hold a U.I.M. superlicence before entry will be accepted.

- 10.5. Any new driver must be vetted during practice by the two U.I.M. Commissioners and the Formula 1 drivers representative to the U.I.M.
- 10.6. To obtain a superlicence, a driver must have participated in 6 circuit races using a catamaran type hull (750cc minimum) or a hydrocat (500cc). Definition of a race during a race weekend, even if several heats are taking place, is that the race weekend with all heats or races is counting for one race only. The National Authorities are fully liable for the sports c.v. they submit for their drivers. The full race results of each race must be supplied since the drivers must have done at least 6 races with 70 % of the total distance of each race event.

The superlicence is provisional for the first 10 races and can be withdrawn at any time during the first 10 races by a committee composed by the OOD, the permanent Formula 1 Commissioner and the Drivers representative. When a provisional superlicence is withdrawn, re-application can only take place for the next season. The decision on all matters concerning superlicenses is final and cannot be protested or appealed.

- 10.7. The application for a superlicence must be made by the National Authority of the driver concerned and lodged with the U.I.M. 4 weeks before the first event the driver wants to participate in. The superlicence fee of 120 Euro will be doubled for applications received beyond the 4 weeks deadline.

The application must be accompanied by:

- The sports career of the driver, mentioning the results obtained in the qualifying events
- A U.I.M. medical document, as per appendix to these rules, giving the information required by the U.I.M. rules 205.03 / 205.04 / 205.04.1

General Recommendation for F1 superlicence holders concerning physical fitness

- Cardiovascular training (endurance training) as jogging, cycling, rowing etc. twice a week – minimum 20 minutes without any interruption. Any sports activity which has “stand still” during the activity such as soccer, tennis or any ball sport is not suitable for the endurance training, but recommended as additional training.
- Training to build up muscles for neck and back at least twice a week.
- The immersion certificate (ref 205.05)
- A photograph
- The fees will be fixed by the Council
- A current rule book will be given to the driver along with the superlicence.

The National Authorities are responsible for the information given.

- 10.8. Superlicence application will be examined by Formula 1 Management Committee who will decide on its acceptability .
- 10.9. The superlicence will be valid for 1 year (from January 1st or from the date of issue to December 31st).
- 10.10. For renewal of superlicenses, the National Authorities must, before the end of December, send the U.I.M. a list of the drivers for whom a renewal for the following year is required.
- 10.11. Each team will appoint one team manager who will be responsible for obtaining a team licence from the U.I.M. for his team, as well as ensuring that the drivers obtain their superlicenses from their N.A.'s. He will also be responsible for enrolling his two boat team in the Championship and for all dealings (contractual, financial) with the U.I.M. and IDEA MARKETING.

He will also be responsible for the behaviour of his team members and his name will be mentioned on the U.I.M. Team Licence.

11. YELLOW CARDS

11.1. All yellow cards issued will be confirmed on a form which will be posted with the results. The driver has 60 minutes to protest to the Protest Judge. If the protest is not upheld, he can appeal. Protests and appeals must be lodged in accordance with U.I.M. rules.

Yellow cards given in other Formulae Series (F2000) will be taken into account on the yellow card listing.

11.2. Yellow cards can be given for the following reasons:

- up to two yellow cards at a time for dangerous driving.
- Red card for extremely dangerous driving

A driver who has a red card or three valid yellow cards will lose the right to take part in the following round of the World Championship (current season or following season), but his boat must participate in the race with a substitute driver. When a penalty of not racing at the next race has been satisfied, the 3 yellow cards or the red card are deleted by the application of that penalty.

11.3. All cards will remain valid for the four events of the Championship following the date on which the last card was delivered.

Participating in training, timed trials, and final race will be considered as having completed one event.

11.4. An organiser/N.A. who has given one or more yellow cards to a driver must inform U.I.M. by fax or mail within 3 days. U.I.M. will inform the next organisers/N.A.'s. of the World Championship races about the delivery of such yellow cards. When a driver has completed 4 races without yellow cards, his previous yellow card(s) will be deleted from the listing.

11.5. Yellow cards issued must be mentioned in the commissioner's report which must be distributed to all members of the relevant U.I.M. Formula commissioners panel.

11.6. Penalties, fines and yellow cards will be issued in accordance with the following list:

INFRINGEMENT	FINE (IN EURO).
Boat and racing gear too late in pits	420 €
Registration after specified time	420 €
Not present at drivers meeting roll call	840 €
Not respecting dress code	135 €
Not respecting exit lane	1 yel or 200 € decision OOD/ U.I.M. Comm.
Not respecting entrance lane	1 yel or 200 € decision OOD/ U.I.M. Comm.
Radio man not at timing control	420 €
Not lining up in 20 seconds	340 €
Not in correct position on parade lap	420 €
Destroying first buoy	1 lap and 420 €
Destroying second buoy	disq. and 420 €
Overtaking under yellow flag	1 lap
In pit during yellow flag	last position
Not in correct position under yellow flag	1 lap
Dangerous driving	1 or 2 yellow
Extremely dangerous/dirty driving	red card
Driver refusing to be weighed separately	405 €
Not using red/yellow light system in boat	420 €
Taking outside assistance	disq
Responsible for stopping the race	disq
Taking technicians on boat (not applicable to the race winner)	340 €
Noise / silencer violation	510 €

Bringing own fuel to race venue	840 €
Not respecting instructions of U.I.M. Comm / and or Officials	200 €
Not connecting fuel pump lanyard to life jacket	1000 €
Closed valve of airbag system :	1500 €
No closing safety belts during time trials, free practice and the race :	5000 €
Jumping the gun :	

Commissioners shall notify the team of the jumping of the gun infringement within 5 laps from the start of the race and then the driver must go back to the last position immediately

Non respect of rules whilst overlapping : the radio man will be show a yellow card – if his boat is still not out of the way, the red card will be shown and his boat will be disqualified.

The Daily Management Committee may decide to apply a “drive-through” immediate-penalty in cases that carry a 1 lap penalty. This will be announced in the advance programme and/or the driver’s meeting ; it will be communicated to the infringing driver’s radio person by race control and the driver must compete the drive through within three laps of the announcement.

The F1 Committee has the right to fine a driver (money or suspension) for any infringement of the rules or any abusive or unsportsmanlike behaviour.

Any financial fines due will be collected by the Race Secretary and held by the Promoter. They will be added to the general prize fund which is distributed at the end of the season.

12. PROCEDURE FOR PROTEST AND APPEAL

12.1. A protest can be lodged in accordance with the 400 rules either by the driver or the team manager

Protests lodged by any driver or his team manager must be handled by the Protest Judge according to the rules.

The protest fee for F1 is 250 Euro.

12.2. An appeal must be submitted in writing (fax, mail) to the U.I.M. office for the attention of Secretary General within the specified time limit and signed by the driver or his team manager.

12.3. The time limit for appeal submission is 48 hours, and is counted from the moment of the communication of the protest judge’s decision to the interested parties

The 24 hours of the Sunday do not count within the 48 hours to appeal. Address, telephone, e-mail, and fax should be clearly mentioned on the appeal so that the U.I.M. can send any correspondence directly to the driver, with a copy to his N.A.

12.4. The driver may agree to forego an Appeal Committee meeting and for the appeal to be handled through telephone and fax, if possible, in order to minimise the costs of the appeal.

12.5. The Formula 1 Committee will select an Appeal Committee of 3 persons, who are neutral and independent parties; the chairman will be legally qualified.

The decision must be given within 7 days and in any case before the start of the following race.

13. SAFETY

13.1. Following an accident, the driver must undergo a physical examination and be passed fit by the event medical staff before being permitted continue in that racing event.

- Following any accident, damaged boats must be completely rechecked and approved by the U.I.M. Commissioner before being permitted to rejoin the event.
- 13.2. Immersion tests at race venues will be carried-out by Osprey at least once during the season, starting with the first event in the calendar. Drivers may alternatively have a test in UK, by arrangement. Drivers entering the series part way through, will be accepted with their own National Authorities immersion test certificate, which will be valid only up to the time of the next immersion test organised by Osprey.
- An example of the certificate and instructions of how to perform an immersion test are available at the U.I.M. Secretariat.
- 13.3. The deformable pickle forks are mandatory according to rule 503.02.
- 13.4. Reinforced cockpits are mandatory according to rule 509
- 13.5. Life jackets incorporating pants, are mandatory.
- Drivers must wear a life jacket so constructed at the shoulders and the legs, that a driver can be easily pulled out of the cockpit.
- “Kevlar” type ballistic material in life jackets/ driving suits is not required.
- Floatation overalls are a permitted alternative to life jackets, but must incorporate extraction handholds for driver removal from the cockpit.
- It is recommended that the colour of the floating overalls is orange.***
- 13.6. The homologated delayed operation buoyancy airbag is mandatory.
- The maintenance of the airbag system is the responsibility of the team.
- 13.7. U.I.M. reserves the right to introduce safety rules effective in a reasonable time following notice.

- 13.8. There will be an official rescue team contracted by the promoter for the entire season.
- All local services provided by the organiser will work in conjunction with the official rescue team under the overall control of the OOD, his substitute or the medical officer.
- 13.9. It is not permitted to take technicians on the boats (financial penalty will be applied).
- The winner can take his technicians for the victory parade lap only. A rescue boat will follow the winning team at close distance.
- 13.10. Seats are mandatory for F1 / **F2000** cockpits and very strongly recommended for all other cockpit classes (for description see 509.08)
- 13.11. Hans device is recommended for F1 – see 509.08
- 13.12 Approved crash safety boxes are recommended in 2006 and mandatory as from 2007 onwards.

14. GENERAL

- 14.1. Drivers who have not committed to participate in all races of the Formula1 World Championship, have to pay an entry fee of 670 € for each race.
- All entries must be made by the team to the U.I.M.
- All entry forms will include the text of the eligibility conditions and the following declaration will have to be signed by all team members « understanding that as a team member / driver I am participating in an U.I.M. Formula 1 Powerboat World Championship event which has ongoing international and sporting significance and in consideration of the acceptance of my participation therein, I agree to be filmed, televised, photographed and otherwise recorded during the World Championship under the conditions and for the purposes now or hereafter authorised by the U.I.M. and the Formula 1 promoter.”

- 14.2. All drivers uniforms and boats must feature series sponsors logo and badges.
- 14.3. The official film crew of the Formula 1 World Championship, will be contracted by the Formula 1 promoter.
- All TV, film, media and commercial rights are the property of the U.I.M.
- The U.I.M. contracted promoter handles the rights on behalf of the U.I.M.
- Any organisation wishing to film or to use existing film must contact the promoter.
- 14.4. The official Formula 1 passes are the recognised access to race events.
- 14.5. The official U.I.M. Formula 1 logo must be prominently displayed on both sides of all participating boats.
- 14.6. The U.I.M. flag shall be flown from the podium if other flags are flown

Enlarged U.I.M. Formula 1 logo has to be prominently displayed on top of the podium during prize giving or during any other public function.

Any correspondence regarding the Formula 1 must be sent to the following address:

UNION INTERNATIONALE MOTONAUTIQUE
 STADE LOUIS II - ENTREE H
 1 AVENUE DES CASTELANS
 MC 98000 MONACO
 Fax: (377) 92-05-04-60
 E-mail: uim@uimpowerboating.com
 Website: www.uimpowerboating.com

UIM F2000 WORLD CHAMPIONSHIP

1. ORGANISATION
2. RACE FORMAT
3. START
4. STOPPED RACE
5. INTERRUPTED RACE
6. RACE COURSE
7. CLASSIFICATION
8. EQUIPMENT
9. FUELS
10. SUPERLICENCES
11. YELLOW CARDS
12. PENALTIES
13. PROCEDURE FOR PROTEST AND APPEAL
14. SAFETY
15. GENERAL
16. INSURANCE

INTERPRETATION OF THE RULES - 200.02

In all cases unforeseen by the international rules, the National Authority is to adjudicate bearing in mind the spirit of the rules.

In case of conflicting rules, those rules concerning the Championship as published in the blue pages of the Circuit Rules Handbook are to prevail.

1. ORGANISATION

- 1.1. The rights of organisation of F2000 races and championships is owned and ruled by the UIM which has granted the management of the competition to the Council
- 1.2. The Council may update the rules whenever necessary.
- 1.3. The F2000 daily management Committee is responsible for the championship daily management. This Committee is composed of the Promoter, the UIM permanent Commissioner and the Formulae Chairman.
- 1.4. The F2000 World Championships are governed solely by the UIM international rules for circuit racing, as published in the white and blue pages of the Circuit Rules Handbook.
- 1.5. A permanent UIM Commissioner will be appointed for the F2000 World championship series which will be held over a minimum of three rounds.
- 1.6. Any additional rule to these specific rules must be justified by national legal requirements and notified in the advance programme
- 1.7. Other Continental Championships will be run subject to the contract between the World Championship Promoter and the UIM.

2. RACE FORMAT

- 2.1. Each F2000 meeting counting towards the Drivers World Championship will include four separate parts to take place over a period of two consecutive days in accordance with the full UIM Circuit rules for racing, classification, protests and appeal and by the specific rules listed below.
- 2.2. In case of force majeure the meeting may take place in one day.

- 2.3. If, through Force Majeur, less than 25% of the programmed total timed trial period is run, the grid positions will be established using the current championship order.
- 2.4. The programme for the event must include:
 - 2.4.1. Free practice (minimum 1 60 minutes);
 - 2.4.2. Two mandatory official timed trials each of 45 minutes duration.
 - 2.4.3. Two sessions of timed trials must be run except in case of "force majeure".

LARGE ENTRY QUALIFYING SYSTEM

A maximum of 24 boats will be allowed in any heat or race – if water registration is less , this will be specified in the advance programme.

If more boats are entered than the maximum water capacity, they will be qualified in accordance with the following method :

On the Sunday, a fixed number of drivers will automatically qualify for the World Championship round, based on the fastest time from their two timed trials.

Those not qualified will run in a single qualification race of 12 minutes on the Sunday morning, and a certain number will be qualified from that race. There will be no other qualifying races.

This system of automatic, and raced-for, qualification will be based on the water homologation maximum and the maximum permitted number of pre-registered entries accepted by the promoter, as indicated in the following table :

Maximum boats permitted in water homologation	24	20	18	16
Maximum permitted drivers pre-entered and accepted by organisation	40	34	30	26
Automatically qualified from Timed Trials 1 & 2	16	14	12	10
Number of drivers in qualifying races	24	20	18	16

Number of drivers going forward from qualifying race into the World Championship round	8	6	6	6
Drivers entered but failing to qualify	16	14	12	10

Depending on the number of drivers entered, and the water capacity, on Saturday there will either be :

Two free practices of 60 minutes, and four timed trial periods of 45 minutes each, with the entry divided into two groups after free practice by using odd and even order of the practice results.

or

Longer single sessions of free practice and timed trials will be organised for the whole entry to participate in at the same time.

In which case the Commissioner will reserve the right at any time to prevent boats leaving the jetty to participate in timed trials depending on the amount of traffic already on the circuit.

Boats may indicate their readiness to start practice runs by parking in a designated waiting area only, and their radio man will be informed when the driver can join the circuit. Boats wishing to make a practice run cannot wait in any area other than the designated one.

2.4.4. The F2000 race [approx. 30 minutes duration, but with a limit of 90 minutes including any re-starts]

2.5. A typical programme would be :

SATURDAY

08.00 to 11.00 Registration and scrutineering

Compulsory drivers and radio men roll-call and meeting, at race headquarters, penalised if not present

Free practice period [60 mins]

First timed trial [45 mins] Each boat entitled to only 15 laps excluding their first lap

Second timed trial [45 mins] Each boat entitled to only 15 laps excluding their first lap

Match Races, covered by separate rules

SUNDAY

Compulsory drivers and radio men roll-call and meeting, at race headquarters. Penalised if not present

Warm-up [45 mins]

Qualifying race

Presentation parade lap

Race

- 2.6. Detailed information about practice, timed trials, Match Races, and number of boats allowed on the circuit must be given in the advance programme
- 2.7. If a race is shortened due to force majeure, it is at the discretion of the OOD and the UIM Commissioner to alter the time table and if necessary the course layout accordingly. In the event of no qualifying times being achieved, the grid will be drawn-up in accordance with the current championship positions.
- 2.8. No entry shall be considered official until the boat has passed the scrutineering and documents controls

3. START

- 3.1. The fastest time recorded for each boat by the official timekeepers, during official timed trials, shall determine the starting positions of boats for the race or the qualifying heats if used.
- 3.2. The start shall be a dead engine jetty start as described in rule 307: Dead engine jetty start.

- 3.3. A course boat will be stationed at a convenient point for the last part of the parade lap, and will show a green flag; at which point the driver can use full revs to clear his engine prior to moving directly into his grid position on the start jetty
- 3.4. Boats should be drawn up stern first with dead engine, to a jetty, floating pontoon or beach. The start must be with the current. The distance between the starting line and the first turning buoy must be at least 300 metres.
- 3.5. When the pontoon marshal is satisfied that all drivers are ready to start, with engines stopped, he will raise a green flag and the OOD will initiate the start procedure. He instructs the starter to raise a 30 seconds board (min. 80 x 80 cm, figures 60 x 10 cm), and when the remote operated start lights are used, blue flashing lights will be operated during the 30 second period.
- 3.6. After 30 seconds this board will be lowered the blue flashing lights switched off, and the red light will be switched on. After 5-12 seconds the red lights are switched off, this is the signal to start.
- 3.7. These drivers rotating their engines (even with ignition switched off) prior to the red lights going off lose one lap.
- 3.8. This lap will be deducted at the end of the race.
- 3.9. The starter may decide if he judges it necessary, to cancel the start by showing the red flag and recommence the starting procedure.
- 3.10. The start jetty must have a minimum length of 70 metres or be equal to 4 metres multiplied by the maximum number of boats permitted to race, [whichever is the greater] and must be at least 1.5 m wide.
- 3.11. All start pontoons must be sufficiently angled (minimum 50 degrees) such that the pole position has a significant advantage towards the first turn buoy, compared with the last positions on the starting grid. The plan of the circuit (including the position of

the start pontoon) must be sent to the commissioner 60 days in advance to get his approval.

- 3.12. Any boat not starting must be returned to shore by the driver's own efforts. Any crew member swimming out to a boat will cause his entry to be disqualified.
- 3.13. Drivers failing to start will wait at the dock until signalled by the pontoon marshal to fall in behind the field.
- 3.14. Before the start of the first race, each driver shall complete a lap of the course immediately after his name has been announced, so that he may be introduced to the public.
- 3.15. An overlap is established only when two boats are on the same course, or approximately the same course, and the cockpit of the overtaking boat, if overtaking from the inside, is even with the cockpit of the overtaken boat. When overtaking from the outside, an overlap is established when the overtaking boat has passed the overtaken boat sufficiently to change lanes without contact. The following rules shall apply to an overlap :
 - The lead boat has the right of way until an overlap is established.
 - A safe overlap is the responsibility of the overtaking boat.
 - Once an overlap is established, the overtaken boat must give the overtaking boat room to clear any course markers.
 - The overtaking boat cannot force an overlap after the lead boat has begun to alter course to negotiate a turn.
 - An overlap can occur from port or starboard.

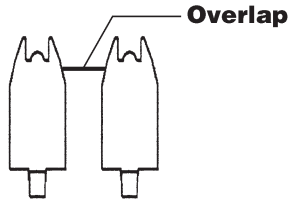

4. STOPPED RACE

- 4.1. In the event that a race is completely stopped rule 311 will apply.
- 4.2. Upon showing the red flag, drivers must return slowly under their own power to the start pontoon [or other position on the circuit notified by the UIM Commissioner during drivers' briefing].
- 4.3. Drivers receiving outside assistance at any point during the race (whether the race has been stopped for an incident or not) will be disqualified.
- 4.4. Boats that have broken down and received outside assistance by being pulled to the infield, or off the race course, will be towed to the trailer or the starting dock only during a "race stop" condition and if pick-up boats are available.
- 4.5. Repairs are allowed at any time during the race, with the exception that replacement of the crankcase and the cylinder block is prohibited. Repairs are not allowed on the race course using outside assistance.
- 4.6. Only if a boat reaches the pontoon on its own power, repairs can be carried-out either while the boat is completely in the water or on its trailer, at the sole discretion of the Pontoon Marshal. Further instructions for the repair areas may be given at drivers briefing.

- 4.7. No repairs are allowed on the start pontoon during the line-up and start or re-start preparations
- 4.8. Drivers may carry-out their own repairs on their boats in accordance with the rules. The driver's two nominated pontoon mechanics and the official crane driver do not count as outside assistance.
- 4.9. In the event of a restart a boat being repaired must be ready to take its position on the grid as directed by the Pontoon Marshal. If the boat is not ready to take its position, it must start at the end of the pontoon.
- 4.10. Hulls and motors must be sealed after scrutineering and before practice. In races with several restarts, substitution of hull or motors between the restarts or during the race is prohibited.
- 4.11. To qualify for points, a stopped race must be restarted if 70% of the total distance specified for the race has not been covered at the time the race is stopped.
- 4.12. The number of laps completed + 1 lap per restart will be deducted from the restarted race.
- 4.13. Should there be a restart, starting positions will be determined by the order of the end of the lap prior to the race being stopped.
- 4.14. All boats which are ready to race, may start in a restarted race.

5. INTERRUPTED RACE - PACE BOAT RULES

- 5.1. The Organiser may interrupt the race for any reasons of safety or emergency services access, and in which case the rescue boats and race control will show yellow flags.
- 5.2. At this signal all drivers must immediately slow down and not overtake. Any overtaking, 5 seconds after the yellow signal has been given, will be penalised by 1 lap. The leading boat, or a specially designated boat, will act as pace boat, and run at slow speed

- 5.3. When the race course is clear, only the yellow flag at race control will be continued to be shown.
- 5.4. All boats maintain their position at slow speed (approx. 4000 rpm) until race control raises the green flag. It is the responsibility of the team managers to ensure that their boat(s) are at the correct position at the restart.
- 5.5. When a rolling re-start is used the UIM Commissioner can show the green flag if the first 10 boats are in their correct positions. The position of the boats for the rolling restart will be that of their race positions on the lap before the yellow signal was given.
- 5.6. Boats which do not restart in their correct position, will be given a one lap penalty..
- 5.7. During the yellow signal situation, a boat may leave the race course but must re-join the race behind the boat running in last position.
- 5.8. In races run with the pace boat system in operation, a yellow flag will be used by race control and the rescue boats to indicate a hazard when displayed stationary, and extreme caution to be exercised by drivers when waved vigorously. No overtaking permitted during yellow flag status.

6. RACE COURSE

- 6.1. Course and safety rules shall be those of the UIM applicable on the date of the race unless specified otherwise by these rules.
- 6.2. The length of straight between any two turning buoys is to be a maximum of 850 metres. The boundaries of the water on which practice and racing are allowed to take place must be defined in the advance programme.
- 6.3. The pit area should be sufficiently large to prevent boats being craned into the water over other boats.
- 6.4. There must be a minimum of 2 cranes.

7. CLASSIFICATION

- 7.1. The boat placed first will be the one having covered the scheduled distance in the shortest time.
- 7.2. All boats will be classified by taking into account the number of complete laps they have covered and for those which have completed the same number of laps, the order in which they crossed the finish line.
- 7.3. The number of laps completed during the eventual restarts will be taken in account for the classification.
- 7.4. The points will be awarded to the first 20 classified drivers on the condition that they have completed at least 70 % of the numbers of laps covered by the winner (rounded down to the nearest whole number of laps). Boats having done 90% or more laps but do not cross the finishing line after the winner has crossed will be classified after those boats that have done the same number of laps but that also cross the finishing line after the winner.
- 7.5. The leading boat must have completed 70 % of the number of laps counting for the race.
- 7.6. If the race cannot be restarted due to “force majeure” then the points will be awarded in accordance to the following scale:

7.6.1. 70% or more of the total race completed	full points
7.6.2. less than 70%	halfpoints
7.6.3. less than 35%	no points
- 7.7. The first six classified boats are to be weighed when coming out of the water. The weighing of the boats can not be protested. The scales will be available before the meeting commences.
- 7.8. Points will be awarded to the first 10 classified drivers in accordance with the following finishing points scale:

First	20 points
Second	15 points
Third	12 points

- | | |
|---------|----------|
| Fourth | 9 points |
| Fifth | 7 points |
| Sixth | 5 points |
| Seventh | 4 points |
| Eight | 3 points |
| Ninth | 2 points |
| Tenth | 1 point |
- 7.9. The overall classification for the F2000 Drivers' World Championship shall be established by the addition of all points obtained by each driver in each of the races counting towards the championship.
- 7.10. In the case of a tie, the number of first places in these races shall be considered, then the second places, etc...
- 7.11. Immediately after the race:
- The winner will complete a lap of honour
 - Presentation of trophies to the first 3 drivers on the official podium. This presentation is only based on a provisional classification, and is subject to confirmation after scrutineering and consideration of any protests or appeals.
- 7.12. At the last race of the series UIM will provide 3 medals (gold, silver, bronze) to be given to the first three in the overall classification of the World Championship.
- 7.13. These medals do not replace the normal prizes (art. 108.01 and 322).

8. EQUIPMENT

8.1. HULL

- 8.1.1. Hull must be a catamaran type, based on twin hulls, but may be of completely free hydrodynamic and aerodynamic design.

- 8.1.2. Must conform to the general UIM rules 501; 502; 503; 504; 508; 509; 542.05 and these F2000 rules.
- 8.1.3. Boats configured to work on the hydrofoil principal will not be eligible.
- 8.1.4. The minimum hull length is 4m80.
- 8.1.5. The minimum weight of the boat and driver as raced is 513 kg *
- * The crash safety boxes will add 25 kilos to the boat weight and therefore the boat weight has been increased with 25 kilos for all boats.
- 8.1.6. Measured in accordance with rule 542.12.
- 8.1.7. The front 305 mm. (12 inch) of the cockpit and pickles should not be made of a material which would not allow controlled deformation to reduce G forces on frontal impact (mandatory).
- 8.1.8. Each wing mirror must have minimum size of 60 sq. cm and be bolted on 2 points to assure proper mounting.
- 8.1.9. Radios in boats are mandatory and a full radio check of each boat will be part of technical scrutineering in order to guarantee that all radios are working. The radioman must be present at race control whenever his boat is on the course. In order to guarantee clear communication between the Team Managers and the UIM Commissioner, all Team Managers must speak English.
- 8.1.10. The homologated delayed operation buoyancy airbag is mandatory.

8.2. MACHINERY

- 8.2.1. Only engines qualifying to the SST120 rules will be eligible for F2000. Engines will be measured and checked against the SST120 data sheets.
- 8.2.2. Maximum engine displacement 2050cc

- 8.2.3. All cowling and engine graphics and colours shall be as OEM, with updating to later models allowed only as a complete OEM design.
- 8.2.4. Engine wiring can be changed to a 24-volt starting system.
- 8.2.5. Gearcases may have their outside surfaces re-profiled, however they must meet the minimum dimensional requirements of the Engine Specification sheets. The outside surfaces of the gearcases may be either painted or unpainted. If they are painted, the colour of the paint must be the same as the original factory motor colour. If the gearcases are unpainted, any surface finished is acceptable.
- 8.2.6. It is permissible to remove, or render inoperable, the engine fuel primer system and plug holes opened-up by removing the system.
- 8.2.7. A maximum of 3 damaged cylinders may be re-sleeved using sleeves from any manufacturer. Sleeve material and the machined port opening's shape and dimensions must all be as original equipment.
- 8.2.8. Reeds may be of any material or design.
- 8.2.9. Cylinder block exhaust port outlet openings may be remachined to the maximum dimensions shown in the Specification Sheet. Only machined openings are acceptable, machined in the same manner as the originals (prior to assembly) in situ hand grinding or blending of any sharp or misaligned edges is not permitted.
- 8.2.10. An Outboard motor is defined as a complete internal combustion power and propulsion unit that can be attached to a boat and which can be lifted bodily from the hull as one unit. Batteries used for ignition and starting, tachometer, throttle control and steering arrangement are excepted.
- 8.2.11. A manufacturer of outboard motors for F2000 Racing is the one who filed specifications and is responsible for the original design and manufacture of the following: crankshaft, connecting rod, cylinder head, cylinder, crankcase, gears and valving

arrangement, and who complied with such other requirements as provided by these rules.

- 8.2.12. Motors must be the product of a recognized manufacturer engaged in the production of outboard motors offered for sale to the general public.
- 8.2.13. There shall be no alterations of parts with the exception of spark plugs, carburettor jets, and propellers, or specific parts approved by the Technical Commission. The intention is to race the engine exactly as manufactured and without special performance boosting accessories.
- 8.2.14. No special parts or interchange of parts will be allowed, unless approved by the Commission.
- 8.2.15. The trim tab, thrust and locking washers may be altered or removed from the lower unit to permit the use of any propeller, thrust washer or nut.
- 8.2.16. Cylinder head and power head attaching studs may be substituted for bolts.
- 8.2.17. Electronic engine RPM limiting devices may be over-ridden or rendered inoperative .
- 8.2.18. Engines (Outboard) as referred to in these rules shall be defined as outboard models which:
- Are manufactured in annual or model year quantities of more than 25 units.
 - Are not necessarily intended for sale and to be used by the general non-racing public.
 - Are not necessarily advertised through the same media, in the same publications and given the same prominence as the manufacturer's other engines.
 - Are not necessarily distributed through the manufacturer's normal channels.

Accessory gearcase, as submitted by the manufacturer, may be used in these engines provided that they are built in a total quantity of no less than 25.

- 8.2.19. Exhaust stacks not contained in the driveshaft housing will not be permitted.
- 8.2.20. Engines may only be run in the configuration that they were homologated in by the Technical Committee.

8.3. REPLACEMENT PARTS

- 8.3.1. Only such parts shall be permitted as are standard production OEM parts used on the motor as the purchaser may obtain it from the dealer as a stock item or electrical or electronic products as approved by the Technical Commission, and published and available to the general public through dealers. These products cannot provide any performance advantage over original OEM parts.
- 8.3.2. No replacement part for current production motors shall be considered standard production until this part appears on current production motors which can be purchased from the dealers.
- 8.3.3. Any replacement part for motors no longer in production shall be approved only after the part being replaced is no longer available for the motor model from the manufacturer or is specifically approved by the Commission.
- 8.3.4. Final approval of non-OEM electrical or electronic parts approved for use in F-2 racing shall not be given until all provisions of the rule have been complied with, and until such time as the manufacturers have built at least 250 units of the part submitted for homologation.
- 8.3.5. For non-OEM electrical or electronic parts, the manufacturer must follow the same rules as specified for motor manufacturer registration with respect to submission of specifications to the Commission and the time period for which the parts are approved.

8.4. MOTOR MODIFICATIONS

- 8.4.1. There shall be no blueprinting or modifications whatsoever to the motor as furnished by the manufacturer other than:
- 8.4.2. Any carburettor jets, spark plugs or propellers may be used provided other parts are not altered to accommodate them with the exception of the trim tab.
- 8.4.3. Only such parts shall be permitted as are used by the motor manufacturer on the particular model as built on the production line. Modifications covered by a manufacturer's service or engineering bulletins are legal seven days after the date of any such bulletin and approval by the Technical Commission, provided all direct purchasers of affected engines are notified by mail as well as all inspectors, followed by printing in the UIM Bulletin at the next opportunity. In the event the manufacturer is unwilling or unable to meet these criteria, modifications covered in such bulletins will be legal after printing in the Propeller.
- 8.4.4. Oversize pistons furnished by the manufacturer of an outboard motor may be used in the model for which they are furnished. The bore of the engine may be enlarged by the amount that the oversize pistons differ from the standard size pistons. An additional total 0.005 inch enlargement of the bore will be allowed for bore enlargement due to wear or re-matching errors, or measuring tolerance. Under no circumstances may the bore be enlarged more than 0.035 inch over the original dimension. It is not permissible to chromium plate cylinder walls unless the motor manufacturer uses chrome plating of cylinder walls as standard production procedure on that particular model.
- 8.4.5. Tachometer, fuel and water pressure, and temperature (including EGT) gauges may be installed if desired.
- 8.4.6. The attachment of a steering bar or its equivalent may be accomplished at any point or points on an engine. Any cowlings or plates removed may be cut and, must be replaced. Any openings created by this operation must be sealed to prevent the

engines from pulling in air. Studs or bolts may be exchanged to secure steering bar.

- 8.4.7. Throttle return springs will be allowed on engines, however no modifications to the engine will be permitted to install same; no drilling of holes, etc. Mounting links may be attached with present fasteners.
- 8.4.8. Isolation Mounts: Only those supplied by the engine manufacturer as original equipment or through the service group are acceptable.
- 8.4.9. Any adjustments of mixture control, throttle and shift linkage will be allowed.
- 8.4.10. Any mechanical adjustments of spark advance will be allowed provided no modifications are made either to the spark advance system or the engine as manufactured.
- 8.4.11. Safety tilt switches and safety starting switches may be disconnected or by-passed.
- 8.4.12. Fuel pumps, filters, heat exchangers or auxiliary tanks may be installed in the boat provided the use of same entails no modification to the engine and fuel lines so used to connect to the fuel connector provided with the engine.
- 8.4.13. The attachment of a power trim system may be accomplished at any point or points on an engine. Only those parts of the production motor interfering with the attachment and function of the trim system may be altered or removed.
- 8.4.14. Bead blasting will be allowed at the block and crankcase interface only. No other internal parts will be allowed to be bead blasted.

9. FUEL

- 9.1. General fuel rules in 508 will apply
- 9.2. Fuel will be supplied by the organiser in conformity with rule 508.01

10. SUPERLICENCES

- 10.1. The nationality of a driver is the nationality of the N.A. which issued the international racing licence to the driver. Medical and immersion tests can be done in other countries if the issuing N.A. agrees. The flag is the one of the issuing N.A. of the international licence as above. The request for the UIM Superlicence must come from the N.A. which issues the international racing licence.
- 10.2. Drivers must hold a UIM super licence before entry will be accepted.

A driver who exceeds 50 years of age in the season for which he is applying for a superlicense, will need to have 2 medical exams conducted. One by a personal doctor and the other one by an appointed UIM doctor.
- 10.3. Any new driver must be vetted in practice by the UIM Commissioner and the drivers delegate to the UIM.
- 10.4. The super licence is required for F2000 2 together with the NA international Licence. No other membership is required.
- 10.5. To obtain a superlicence, a driver must have participated in 6 circuit races in any catamaran 0 or S class or hydrocat min 500 cc. Definition of a race during a race weekend: even if several heats take place, the race weekend with all heats or races counts as one race only. The National Authorities are fully liable for the sports c.v. that they submit for their drivers. The full race results of each race must be supplied since the drivers must have done at least 6 races with 70 % of the total distance of each race event.
- 10.6. The superlicence is provisional for the first 3 races and can be withdrawn at any time during the first 3 races by a committee composed by the OOD, the UIM Commissioner and the Drivers representative. When a super licence is withdrawn, next application can only take place for the next season.
- 10.7. The application for a super licence must be made by the National Authority of the driver concerned and lodged with the UIM 4 weeks before the first event the driver wants to participate in. The

superlicence fee of 120 Euro. will be doubled for applications received beyond the 4 weeks deadline.

10.8. The application must be accompanied by:

- The sports career of the driver, mentioning the results obtained in the qualifying events
- A U.I.M. medical document, as per appendix to these rules, giving the information required by the UIM rules 205.03/ 205.04 / 205.04.1

General Recommendation for F2000 superlicence holders concerning physical fitness

- Cardiovascular training (endurance training) as jogging, cycling, rowing etc. twice a week – minimum 20 minutes without any interruption. Any sports activity which has “stand still” during the activity such as soccer, tennis or any ball sport is not suitable for the endurance training, but recommended as additional training.
- Training to build up muscles for neck and back at least twice a week.
- The immersion certificate (ref 205.05)
- A photo
- The fees will be fixed by the General Assembly
- A current rule book will be given to the driver along with the super licence.

10.9. The National Authorities are responsible for the information given.

10.10. The application will be examined by Formulae Committee who will decide on its acceptability.

10.11. The decision of the Formulae Committee on all matters concerning superlicences is final and cannot be protested or appealed.

10.12. The super licence is valid for 1 year (from January 1st or from the date of issue to December 31st).

10.13. For renewal of the super licences, the National Authorities must, before the end of December, send the UIM a list of the drivers for whom a renewal for the following year is required.

11. YELLOW CARDS

Yellow cards given in other Formulae Series (F1) will be taken into account on the yellow card listing.

- 11.1. Yellow cards can only be given for the behaviour on the water.
- 11.2. A yellow card will be confirmed on a form which will be posted with the results. The pilot has 60 minutes to protest to the jury.
- 11.3. If the protest is not upheld, he can appeal. Protests and appeals must be lodged according to UIM rules.
- 11.4. A yellow card can be given by:
 - * the Officer of the Day
 - * the UIM Commissioner
- 11.5. The yellow card can be given according to the following:
 - 11.5.1. Up to two yellow cards at a time for dangerous driving.
 - 11.5.2. Red card for extremely dangerous driving and unsportsmanlike behaviour
- 11.6. A driver who has been given three yellow cards or a red card loses right to take part in the next event of the World Championship or Continental Championship (current season or following season). When a penalty of not racing at the next race has been satisfied, the 3 yellow cards or the red card are deleted by the application of that penalty.
- 11.7. All cards will remain valid for the four following events of the Championship as from the date on which the last card was delivered.
- 11.8. Participating in training, timed trials and final race will be considered as having completed one event.

- 11.9. An organiser/N.A. who has given one or more yellow cards to a driver must inform UIM by telefax or mail within 3 days. UIM will inform the next organiser/N/A. of a World Championship race or the Continental Championship about the issue of such yellow cards. When a driver has completed 4 races without yellow cards, his previous yellow card(s) will be deleted from the listing.
- 11.10. Yellow cards issued must be mentioned in the commissioner's report which must be distributed to all members of the relevant UIM Formula commissioners panel.
- 11.11. Temporary suspension: see article 406.05

12. PENALTIES

- 12.1. Penalties will be issued to drivers in accordance with the following list :

INFRINGEMENT	FINE (IN Euro).
12.2. Not present at drivers meeting roll call	200
12.3. Not under crane when called forward	150
12.4. Not respecting exit lane	100
12.5. Not respecting entrance lane	100
12.6. Radio man not at timing control	200
12.7. Not lining up promptly on jetty	150
12.8. Not in correct position on parade lap	100
12.9. Destroying first buoy	1 lap and 200
12.10. Destroying second buoy	Disq. and 200
12.11. Overtaking under yellow flag	1 lap
12.12. In visiting pit during yellow flag	last position
12.13. Not in correct position under yellow flag/re-start	1 lap

- 12.14. Taking technicians on boat on the course (excl. the race winner) 200
- 12.15. Bringing own racing fuel to race venue 300
- 12.16. Not respecting instructions of UIM Comm / and or Officials 150
- 12.17. Closed valve of airbag system 1500 Not closing safety belts during time trials,5000 free practice and the race Not connecting fuel pump lanyard to life jacket 1000
- 12.18. The Formula Committee has the right to fine a driver (money or suspension) for any infringement of the rules or any abusive or unsportsmanlike behaviour.
- 12.19. The Daily Management Committee may decide to apply a "drive-through" immediate-penalty in cases that carry a 1 lap penalty. This will be announced in the advance programme and/or the driver's briefing ; it will be communicated to the infringing driver's radio person by race control and the driver must complete the drive through within three laps of the announcement.

13. PROCEDURE FOR APPEAL

- 13.1. Appeals will be handled according to the 400 Jurisdiction rules.
- 13.2. The delay to appeal is counted from the moment of the communication of the Jury decision to the interested parties and it is 48 hours.
- 13.3. The 24 hours of the Sunday do not count within the 48 hours to appeal. Address, telephone and fax should be clearly mentioned on the appeal so that the UIM can send any correspondence directly to the driver with copy to his N.A. The driver may agree to forego an Appeal Committee meeting and for the appeal to be handled through telephone and fax - if possible - in order to minimize the costs of the appeal.

14. SAFETY

- 14.1. Drivers must wear a floatation vest incorporating pants, and so constructed at the shoulders and the legs that a driver can be easily pulled of the cockpit. Floatation overalls are a permitted alternative to life jackets, but must incorporate extraction handholds for driver removal from cockpit.
- 14.2. The homologated delayed operation buoyancy airbag is mandatory. The maintenance of the airbag system is the responsibility of the team.
- 14.3. Drivers taking technicians on their boats will be penalised.
- 14.4. The winner can take his technicians for the victory parade lap only. A rescue boat will follow the winning team at close distance.
- 14.5. The winner can take his technicians for the victory parade lap only. A rescue boat will follow the winning team at close distance.
- 14.6. Hans device is recommended for F2000 see 509.08
- 14.7. Seats are mandatory for F1 / **F2000** cockpits and very strongly recommended for all other cockpit classes (**for description see 509.08**).
- 14.8. The crash safety boxes are recommended for 2006 and will be mandatory as from 2007 onwards.

15. GENERAL

- 15.1. The official UIM sticker is mandatory and must be visibly displayed on all participating boats.
- 15.2. All TV, film, media and commercial rights are the property of the UIM.
- 15.3. The UIM contracted promoter handles the rights on behalf of the UIM.
- 15.4. Any organisation wishing to film or to use existing film must contact the promoter.

16. INSURANCE

- 16.1. The advance programme must contain following information:
- 16.2. Terms and conditions of a mandatory insurance for personal and material damage on third parties, competitors included
- 16.3. The minimum limit of coverage required
- 16.4. The type of risks to be covered by the insurance
- 16.5. Whether insurance from other National Authorities are accepted and if they are, in which language they must be drawn up
- 16.6. The amount of insurance fees to be paid on the spot.

17. FINANCIAL CONDITIONS OF A F2000 WORLD EVENT

- 17.1. To confirm a calendar request we ask you to transfer to our bank account BEFORE FEBRUARY 28, the following amounts:
760 Euro: calendar fee
- 17.2. Prize fund and travel costs will be furnished by the promoter and agreed directly with the drivers
- 17.3. Any correspondence regarding F2000 must be sent to the following address:

UNION INTERNATIONALE MOTONAUTIQUE
 STADE LOUIS II - ENTREE H
 1 AVENUE DES CASTELANS
 MC 98000 MONACO
 Fax: (377) 92-05-04-60
 E-mail: uim@uimpowerboating.com
 Website: www.uimpowerboating.com

U.I.M. FORMULA 3 WORLD CHAMPIONSHIP

**THE FORMULA 3 WORLD CHAMPIONSHIP TITLE IS
SUSPENDED UNTIL A VIABLE FORMULA AND ANNUAL RACE
FORMAT IS ESTABLISHED**

U.I.M. FORMULA 500 WORLD CHAMPIONSHIP

«Dieter König Memorial»

1. ORGANISATION
2. RACE FORMAT
3. CLASSIFICATION
4. STOPPED RACE
5. YELLOW CARDS
6. COMMITTEE OF APPEAL
7. SAFETY
8. GENERAL

INTERPRETATION OF THE RULES - 200.02

In all cases unforeseen by the international rules, the National Authority is to judge bearing in mind the spirit of the rules.

In case of conflicting rules, those rules concerning the series are to prevail.

1. ORGANISATION

The organisation of F500 races and championships is owned and ruled by the U.I.M.

The Council may update the rules whenever necessary, only if the Formula is promoted by a contracted promoter.

Meetings in Formula 500 are reserved to boats of the O series, equipped with 351 cc to 500 cc outboard engines.

The championship is open to all drivers (their number per National Authority being unlimited) who will produce evidence that they have

participated satisfactory in at least 5 international or national races in the O series.

The official U.I.M. sticker is mandatory and must be affixed on all participating boats.

2. RACE FORMAT

The Championship includes a minimum of 4 and a maximum of 6 races organised in different countries, with a minimum interval of two weeks between races if possible. The U.I.M. reserves the right to allocate the Championship even if the minimum number of races are not held or awarded points.

Applications to hold a F500 event will be allocated in the normal way (rule 108.01, but using the English names of the country applying) except that one National Authority can be allocated two events provided the maximum number has not been requested by other National Authorities.

If 6 races are run with points allocated, the 5 best results count for the final classification.

It is recommended that all races use a jetty start (rule 307).

CIRCUIT:

The length of the lap will be included between 1500 and 2000 meters;

- The length of a qualifying heat will be included between 8 and 12 km;
- The number of boats authorised on the circuit must be announced in the advance-programme.

RACE:

Each race will include 3 final heats.

If the number of drivers present exceeds the number admissible on the circuit, qualifying heats will take place.

The composition of qualifying heats will be determined by the classification of official timed trials: drivers with an odd position (1, 3, 5,

etc...) will be put together in one series, drivers with an even position (2, 4, 6, etc...) in the other series. Drivers who have not participated in trials will be split between the qualifying heats.

Each series will run a selection heat and certain drivers a supplementary heat.

Example based on the presence of 30 boats on a circuit authorised for 14 boats:

3 series of 10 boats will be formed:

At the end of the selection races for these series, the 4 first of each series will be selected ($3 \times 4 = 12$).

The supplementary heat will be run by the 14 non selected drivers with the greatest point totals, the two first of this heat will be selected to participate in the final ($1 \times 2 = 2$) giving a total for the final of $12 + 2 = 14$ drivers.

If necessary, after all the qualifying races, the organisers reserve the right to make up the number of boats in the final races to the maximum permitted from the repechage heat, when any qualified driver indicates that they cannot participate in the final heats. This cannot be done after the first heat.

An interval of at least one hour will be mandatory between final heats and between the last qualifying heat and the first final heat.

If the qualifying heats are of a different number of laps-positions on the jetty for the final races are from lap times - if not available then the positions in which they finish their heat will be intermingled - the first being the winner of the longest qualifying heat.

3. CLASSIFICATION

The classification of the race will be drawn-up by adding up each driver's points in every final heat (scale referred to in article 318.01).

In order to obtain a general classification of the European Championship, the first drivers classified in races taken into account in a championship will be given points as follows:

1st: 20 points	6th: 10 points	11th: 5 points
2nd: 17 points	7th: 9 points	12th: 4 points
3rd: 15 points	8th: 8 points	13th: 3 points
4th: 13 points	9th: 7 points	14th: 2 points
5th: 11 points	10th: 6 points	15th: 1 point

The winner of the Championship will be the driver who will have accumulated the highest number of points.

In case of a tie, the number of first positions, second positions etc. will be successively taken into consideration.

In case of a new tie, all U.I.M. points collected in all races counting for the Championship will be added up (scale referred to in article 318.01) applied to the general classification of each event.

At the last race of the series U.I.M. will provide three medals (gold, silver, bronze) to be given to the three first classified in the general classification.

4. STOPPED RACE

A stopped race is a race which has been interrupted by the Officer of the day after the start. Stopping the race is decided by the Officer of the Day for reason of force majeure of which he is the sole judge. A race must be stopped when any body is in the water as a result of an accident (blow over, roll, submarining, collision, etc...) as the continuation of the race constitutes a danger to those involved.

A stopped race may only be repeated twice.

- A stopped race must be repeated twice if necessary
- When the leading boat has completed less than 70 % of the required laps the race shall be re-started.
- First restart, full number of laps, refuelling is allowed.
- Only drivers scored on the lap before the stoppage, can restart.

- If a first re-started race is also stopped before 70 % of the required laps have been completed by the leading boat, the race shall have a second start.
- A second restarted race does not allow refuelling.
- Laps for a second restarted race shall be:
Add 1 lap to the full number of laps completed before the stoppage - take these away from original number of laps - new race distance.
Example: restarted race stopped on lap 4 in an 8 lap race: 3 laps completed + 1.
8 laps - 4 = 4 laps for second restarted race
- If a second restarted race is also stopped: results - up to 35 % of required laps 50 % points. 35 % and over = full points.
- Any penalty incurred in any race is carried forward to any restart of that race.

If two repeated races are provided for in the advance programme, the first one must be a complete race (total number of foreseen laps) and the second one according to the following format.

If only one repeated race instructions will be given in writing to the drivers during a special drivers meeting.

No refuelling is allowed between a stopped race and a repeated race, except if the repeated race is a complete heat.

Only the drivers scored at the lap before the stop, are allowed to restart.

Points will be awarded according to the following system:

up to 35% of the distance	1/2 points
above 35% of the distance	total points

5. YELLOW CARDS

Yellow cards can only be given for the behaviour on the water. A yellow card will be confirmed on a form which will be posted with the results. The pilot has 60 minutes to protest to the jury. If the protest is not

accepted, he can appeal. Protests and appeals can be lodged according to U.I.M. rules.

A yellow card can be given by:

- the Officer of the Day
- the U.I.M. Commissioner

The yellow card can be given according to the following:

- up to two yellow cards at a time for dangerous driving.
- red card for extremely dangerous driving

A driver who has been given three yellow cards or a red card loses his right to take part in the following competition of the World Championship (current season or following season).

All cards remain valid for the four following competitions of the Championship as from the date on which the last card was delivered. When the penalty of not racing at the next race has been applied, the 3 yellow cards are deleted through the penalty.

Timed trials, qualification race and final race count as one event.

An organiser/N.A. who has given one or more yellow cards to a driver must inform U.I.M. by telefax or mail within 3 days. U.I.M. will inform the next organiser/N.A. of a World Championship race or the Continental Championship about the delivery of such yellow cards. When a driver has done 4 races without yellow cards, his previous card(s) will be deleted from the listing.

Given yellow cards must be mentioned in the commissioner's report which must be distributed to all members of the relevant U.I.M. Formula commissioners panel.

6. COMMITTEE OF APPEAL

Appeals will be handled according to the 400 Jurisdiction rules.

The delay to appeal is counted from the moment of the communication of the Jury decision to the interested parties and it is 48 hours.

The 24 hours of the Sunday do not count within the 48 hours to appeal.

Address, telephone and fax should be clearly mentioned on the appeal so that the U.I.M. can send any correspondence directly to the driver with copy to his N.A. The driver may agree on having no Appeal Committee meeting but to handle the appeal through telephone and fax - if possible - in order to limit the costs of the appeal.

7. SAFETY

Races in Formula 500 are reserved only for boats conforming to the following specifications:

Minimumweight:180 kg Minimumlength:3.85m Cockpit mandatory

Minimum weight mentioned above is the weight of the complete rig weighed directly after the race, without driver, residual water but including residual fuel.

Minimum weight with driver: 260 kg

Reinforced cockpits are mandatory according to rule 509 for F500.

Before racing a craft with restraint system, all drivers must have passed an immersion test in a restraint system to ensure that they can exit a reinforced compartment successfully.

The immersion certificate should be provided by the National Authority of the driver and includes an immersion test in a simulated reinforced cockpit. The immersion test and the certificate must be renewed every 14 months.

A model for the certificate and instructions of how to perform an immersion test are available at the U.I.M. Secretariat.

All catamaran type hulls must have the deformable pickle forks according to rule 503.02.

Drivers must wear of flotation vest so constructed at the shoulders that a driver can be easily pulled of the cockpit.

Seats are mandatory for F1 cockpits and highly recommended for all other cockpit classes. See 509.08

8. GENERAL

FINANCIAL CONDITIONS

1720 € prize money:

Distributed by the organiser to the drivers at the end of the race, before they leave the racing place (after the end of the protest time).

1st:	370 €
2nd:	250 €
3rd:	200 €
4th:	180 €
5th:	170 €
6th:	150 €
7th:	130 €
8th:	100 €
9th:	90 €
10th:	80 €

5000 € travelling money:

Travelling money for foreign participants is to be divided equally between the registered competing foreign drivers to a maximum of **400** €. Drivers who fail to send in their registered entry forms in due time, according to the advance programme/regulations, may lose all their travel money.

All prize and travel money must be paid in Euro. Organisers unable/unwilling to pay in Euro will have to pay an increase of 10 % on all the amounts due to the drivers.

All TV, film, media and commercial rights are the property of the U.I.M.

If the U.I.M. has a contracted promoter, he handles the rights on behalf of the U.I.M.

Any organisation wishing to film or to use existing film must contact the U.I.M. or the promoter.

Any correspondence regarding Formula 500 must be sent to the following address:

UNION INTERNATIONALE MOTONAUTIQUE
 STADE LOUIS II - ENTREE H
 1 AVENUE DES CASTELANS
 MC 98000 MONACO
 Fax: (377) 92-05-04-60
 E-mail: uim@uimpowerboating.com
 Website: www.uimpowerboating.com

U.I.M. FORMULA 4 WORLD CHAMPIONSHIP

1. ORGANISATION
2. RACE FORMAT
3. START
4. STOPPED RACE
5. RACE COURSE
6. CLASSIFICATION
5. EQUIPMENT
6. ENTRIES
7. YELLOW CARDS
8. COMMITTEE OF APPEAL
9. SAFETY
10. GENERAL

INTERPRETATION OF THE RULES - 200.02

In all cases unforeseen by the international rules, the National Authority is to judge bearing in mind the spirit of the rules.

In case of conflicting rules, those rules concerning the series are to prevail.

1. ORGANISATION

The organisation of F4 races and championships is owned and ruled by the U.I.M.

The Council may update the rules whenever necessary, if the Formula is promoted by a contracted promoter.

Formula 4 races are reserved for boats of the S.850 class, governed by the rules 540.

The F4 World Championship is open to all drivers (their number is unlimited for each National Authority).

The Championship will be run in a maximum of 5 meetings organised in different countries, with a minimum of two weeks between races.

Provided that the number of applications is not sufficient, one single National Authority may be allowed to organise two meetings.

2. RACE FORMAT

It is recommended that each meeting of the F4 World Championship be composed of 4 parts that should take place within a period of two consecutive days, in conformity with U.I.M. rules on circuit races, further completed by the specific rules set hereafter.

The various parts of the meeting are as follows:

- 1) free practice (minimum 2 x 1 hour);
- 2) Mandatory timed trials:

Timed trials should cover 2 or 3 laps for each boat in each trial series;

2 series must be organised, except in a case of force majeure; All data concerning the trials and the number of authorised boats must be printed in the advance-programme.

Should the number of drivers at the race exceed the number of boats allowed on the circuit, a qualifying race will have to be organised. The composition of the qualifying series will be determined by the results obtained at the official timed trials; drivers in an odd-numbered position (1, 3, 5...) will be in one series, those in an even-numbered position (2, 4, 6...) will be in another series.

The drivers who have not taken part in trials will be distributed among the two series.

For each series there will be a selection race and some drivers will run a second chance race.

Example based on 30 boats on a circuit planned for 20 boats:

There will be two series of 15 boats.

At the end of the selection races for these series, the first eight boats in each series will be selected ($2 \times 8 = 16$).

The second chance heat will be run by 14 unselected drivers; the first four in this boat will be allowed to take part in the final race ($1 \times 4 = 4$).

That is to say total number of $16 + 4 = 20$ drivers for the final race.

A minimum one-hour interval is required between final heats as well as between the last qualifying heat and the final heat.

Championship race - from 50 to 60 km.

The organiser is required to mention in the advance-programme the number of laps which is determined by the length of his circuit.

A U.I.M. Commissioner is required at each race.

No other class of boats is allowed to take part in Formula 4 Championship.

The maximum length of a straight line between two turning buoys is 850 meters.

The shortest time recorded by official timekeepers for each boat will determine the position of boats on the starting grid. Should a boat starting a race be different from the boat that was used for trials, it will be put in the last position on the starting grid.

If a race is shortened due to force majeure, it is at the discretion on the OOD and the U.I.M. Commissioner to alter the time table and if necessary the course accordingly. In the event of no qualifying times being posted the grid will be drawn on current championship positions.

3. START

The start will be dead engine start, as follows:

Dead engine start

Boats will be drawn up stern first, engine dead, to a jetty, a floating stage or beach.

The distance between the starting line and the first turning buoy must be at least 300 meters.

When the pontoon marshal is satisfied that all drivers are ready to start, with engines stopped, he raises a green flag and the OOD starts the start procedure. He instructs the starter to raise a 30 seconds board (min. 80 x 80 cm, figures 60 x 10 cm).

30 seconds after this board is raised the red light is switched on.

After 5-12 seconds the red lights are switched off, this is the signal to start. These drivers rotating their engines (with ignition switched off) prior to the red lights going off lose one lap. This lap will be deducted at the end of the race.

The starter may decide if he judges it necessary, to cancel the start by presenting the red flag and recommence the starting procedure.

Before the start of the first race of each meeting of the Championship, when his name is called, each driver will lap the circuit to make it possible for the organiser to introduce him to the public.

4. STOPPED RACE

In the event of the race being stopped boats will return to the starting pontoon, under their own power.

Drivers taking outside assistance at any point during the race (whether the race has been stopped for an incident or not) will be disqualified.

Boats that have broken down and pulled to the infield or off the race course will be towed to the trailer or the starting dock only during a «race stop» condition and if pick-up boats are available.

Only if the boat reaches the pontoon on its own power, repairs can be made on the rear side of the start pontoon or on the launching pontoon, while the boat is completely in the water or on its trailer. Further instructions for the repair area may be given at drivers briefing.

In case of a restart the boat being repaired must be ready to take its position on the grid at the instruction of the pontoon marshal. If the boat is not ready to take its position, it must start at the end of the pontoon.

Hulls and motors have to be sealed after scrutineering and before practice. In races with several restarts, substitution of hull or motors between the restarts or during the race is prohibited.

To qualify for points, a stopped race must be restarted if 70% of the total distance specified for the race has not been covered at the time the race is stopped.

The number of laps completed by the leading boat + 1 lap per restart will be deducted from the restarted race.

Should there be a restart, starting positions will be determined by the order of the end of the lap prior to the race being stopped.

All boats which are ready to race, may start in a restarted race. After the finish of the race, the race organiser might find out who has caused the stoppage of the race and the driver or drivers responsible for the stoppage, will not score.

5. RACE COURSE

Water registration - see rule 106.02

Course and safety rules shall be those of the U.I.M. applicable on the date of the race unless specified otherwise by these rules.

The length of straight between any two turning buoys is to be a maximum of 850 metres. The boundaries of the water on which practice and racing are allowed to take place must be defined in the advance program.

The pit area should be sufficiently large to prevent boats being craned into the water over other boats.

There must be a minimum of 2 cranes.

Every turn on the race course must have two turn buoys.

If a driver

- touches the first turn buoy in a turn: no penalty
- damages or destroys the first buoy: one lap penalty
- touches the second buoy: no penalty
- damages, destroys or dislodges the second buoy: disqualification

The penalty lap will be deducted at the end of the race.

When passing a mark and an overlap has been established, both boats must maintain their lane, i.e. they must maintain their distance from the mark until the mark has been rounded.

6. CLASSIFICATION

All boats will be classified taking into account the number of complete laps they have covered and for those which have completed the same number of laps, the order in which they crossed the arrival line.

The number of laps completed during the eventual restarts will be taken in account for the classification.

The points will be granted to the first 15 classified drivers on the condition that they have completed 90% of the number of laps covered by the winner (rounded down to the nearest whole number of laps).

The leading boat must have completed 70% of the number of laps counting for the race.

In the event of the race being stopped, boats will return to the start pontoon.

Drivers taking outside assistance at any point during the race (whether the race has been stopped for an incident or not) will be disqualified.

Boats that have broken down and pulled to the infield or off the race course will be towed to the trailer on the starting dock only during a «race stop» condition and if pick-up boats are available.

Only if the boat reaches the pontoon on its own power, repairs can be made on the rear side of the start pontoon or on the launching pontoon, while the boat is completely in the water or on its trailer. Further instructions for the repair area may be given at drivers briefing.

In case of a restart the boat being repaired must be ready to take its position on the grid at the instruction of the pontoon marshal. If the boat is not ready to take its position, it must restart at the end of the pontoon.

Only those drivers scored at the end of the lap before the stop are allowed to restart.

In case of a re-start, the positions on the grid are determined by the classification made at the end of the lap preceding the race stoppage.

If there is no re-start, the classification is the one established at the end of the lap preceding the stoppage of the race. The driver(s) responsible for the race stoppage are not classified.

Points will be granted according to the following schedule:

70 % or more of the total race	total points
less than 70 %	half of the points
less than 35 %	no points

The points awarded will be as follows:

1st: 20 points	6th: 10 points	11th: 5 points
2nd: 17 points	7th: 9 points	12th: 4 points
3rd: 15 points	8th: 8 points	13th: 3 points
4th: 13 points	9th: 7 points	14th: 2 points
5th: 11 points	10th: 6 points	15th: 1 point

The general classification of the F4 World Championship will be established by adding-up the points collected in each race of the Championship. In case of a tie, the number of first places and then 2nd

places, 3rd, etc... will be taken into account. In case of a last tie, all U.I.M. points (schedule 318.01) collected during all the races of the Championship will be added-up and will decide which of the drivers is the winner.

At the last race of the series U.I.M. will provide three medals (gold, silver, bronze) to be given to the three first classified in the general classification.

Immediately after the race, the first three in the meeting will be introduced to the public and to the media on the official podium. This introduction is only a provisional classification subject to modification after the developments of the race and the protests, if any, have been examined.

The first six classified boats are weighed with scales when coming out of the water. The weighing of the boats can not be protested. The scales will be available before the meeting commences.

7. EQUIPMENT

ENGINES

F4 driver's World Championship is reserved to boats equipped with one single naturally aspirated outboard engine complying with the requirements contained in rules 540 regarding class S.850.

FUEL

- General fuel rules 508 will apply
- Fuel will be supplied by the organiser in conformity with rule 508.01
- Unleaded sports engine fuel in rule 508.02 will apply.

HULL

All boats must be equipped with an isolation switch placed as close as possible to the positive pole of the battery(ies) (negative pole if the earthing is done via the positive pole). The handle of this switch must be easily reached on the deck or any other surface of the boat (preferably on the portside, 1 to 3 meters from the stern). The switch should be indicated by a red arrow and clearly show the ON/OFF positions.

The weight of the boat, driver and personal equipment included: 330 kg minimum (250 kg minimum for the boat plus 80 kg for the driver).

The minimum length is 3.90 m measured along the sponson.

Reinforced cockpit is mandatory.

No entry shall be considered official before the boat has passed the scrutineering and the document controls.

8. ENTRIES

Each National Authority is fully responsible for its driver's qualification. Registration forms will have to bear the authorisation to start delivered by the National Authority of the competitor (U.I.M. 203.01 - 1 st paragraph).

All holders of an international licence will be allowed to take part in races.

9. YELLOW CARDS

Yellow cards can only be given for the behaviour on the water. A yellow card will be confirmed on a form which will be posted with the results. The pilot has 60 minutes to protest to the jury. If the protest is not accepted, he can appeal. Protests and appeals can be lodged according to U.I.M. rules.

A yellow card can be given by:

- the Officer of the Day
- the U.I.M. Commissioner

The yellow card can be given according to the following:

- up to two yellow cards at a time for dangerous driving.
- red card for extremely dangerous driving

A driver who has been given three yellow cards or a red card loses his right to take part in the following competition of the World Championship or Continental Championship (current season or following season). All cards remain valid for the four following competitions of the Championship as from the date on which the last card was delivered. When the penalty

of not racing at the next race has been applied, the 3 yellow cards are deleted through the penalty.

Participating in training, timed trials and final race will be considered as having done one event.

An organiser/N.A. who has given one or more yellow cards to a driver must inform U.I.M. by telefax or mail within 3 days. U.I.M. will inform the next organiser/N.A. of a World Championship race or the Continental Championship about the delivery of such yellow cards. When a driver has done 4 races without yellow cards, his previous card(s) will be deleted from the listing.

Given yellow cards must be mentioned in the commissioner's report which must be distributed to all members of the relevant U.I.M. Formula commissioners panel.

Temporary suspension: see article 406.05

10. COMMITTEE OF APPEAL

Appeals will be handled according to the 400 Jurisdiction rules.

The delay to appeal is counted from the moment of the communication of the Jury decision to the interested parties and it is 48 hours.

The 24 hours of the Sunday do not count within the 48 hours to appeal.

Address, telephone and fax should be clearly mentioned on the appeal so that the U.I.M. can send any correspondence directly to the driver with copy to his N.A. The driver may agree on having no Appeal Committee meeting but to handle the appeal through telephone and fax - if possible - in order to limit the costs of the appeal.

11. SAFETY

Reinforced cockpits are mandatory according to rule 509

Before racing a craft with restraint system, all drivers must have passed an immersion test in a restraint system to ensure that they can exit a reinforced compartment successfully.

The immersion certificate should be provided by the National Authority of the driver and includes an immersion test in a simulated reinforced cockpit. The immersion test and the certificate must be renewed every 14 months.

A model for the certificate and instructions of how to perform an immersion test are available at the U.I.M. Secretariat.

The deformable pickle forks are mandatory according to rule 503.02.

Life jackets incorporating pants, are mandatory.

Seats are mandatory for F1 cockpits and highly recommended for all other cockpit classes. See 509.08.

Drivers must wear of flotation vest so constructed at the shoulders and the legs that a driver can be easily pulled of the cockpit.

12. GENERAL

FINANCIAL CONDITIONS

Each National Authority wishing to organise a Formula 4 race will have to guarantee the amount of 2000 € to be distributed as follows:

2000 € prize money:

Distributed by the organiser to the drivers at the end of the race, before they leave the racing place (after the end of the protest time).

1st:	340 €
2nd:	290 €
3rd:	250 €
4th:	220 €
5th:	200 €
6th:	180 €

7th: 160 €

8th: 140 €

9th: 120 €

10th: 100 €

500 € year end prize money:

To be deposited at U.I.M. BEFORE the 28th February of the year of the organisation, for the prize money of the general classification of the Championship.

The year end prize money will be paid by U.I.M. after the last race, according to the general classification of the championship and after examining all possible protests: 4 € for each point accumulated by each driver in the general classification.

All TV, film, media and commercial rights are the property of the U.I.M.

The U.I.M. contracted promoter handles the rights on behalf of the U.I.M.

Any organisation wishing to film or to use existing film must contact the promoter.

All correspondence related to the F4 World Championship should be sent to the following address:

UNION INTERNATIONALE MOTONAUTIQUE
 STADE LOUIS II - ENTREE H
 1 AVENUE DES CASTELANS
 MC 98000 MONACO
 Fax: (377) 92-05-04-60
 E-mail: uim@uimpowerboating.com
 Website: www.uimpowerboating.com

U.I.M. FORMULA 1000 INTERNATIONAL

1. DENOMINATION
2. HULL
3. MOTOR
4. PROPELLER
5. FUEL
6. YELLOW CARDS
7. COMMITTEE OF APPEAL
8. SAFETY
9. GENERAL

TECHNICAL RULES

1. DENOMINATION

The Formula 1000 European Championship is an outboard monobrand class.

The Championship includes up to 4 races organised in different countries.

The final classification of each of these four events will be calculated using the drivers' best three heats and the 25 % reducing points system (400, 300, 225 etc).

The overall classification of the European Championship will be calculated by awarding points for positions in the final classification of each of the four events using the 20, 17, 15 etc points system.

The heat distance will be 20 to 25 km.

2. HULL

The hull must be of a catamaran type provided with safety cockpit and pickle-forks in accordance with the U.I.M. rules. The minimum dimensions must be the following:

minimum length 3,90 m

minimum weight of the boat 250 kg (325 kg with driver) immediately after the race with residual fuel and without residual water.

3. MOTOR

The motor must be a SELVA FORMULA 1000 homologated by U.I.M.

The electric supply of the system must be 12 Volt (including trim system).

The lift system is mechanic and must be not modified. Any machinery aimed at modifying the height of the motor during the race is forbidden.

Carburettors must remain standard in any of their parts.

Cylinder sleeves cannot be substituted and cannot undergo any remarking.

The cooling water must circulate through the water pump and be fed only through the standard water intake, neither the position nor the shape of which may be modified.

The use of non SELVA parts are forbidden.

Sole modifications allowed:

- It is permissible to use any ignition wire , spark plugs (not exceeding into combustion chamber), propeller nut.
- It is permissible to use any fuel line or fittings. A fuel filter may also be used.
- It is possible to add a fuel supply electric pump without changing the original system of engine supply.
- It is permissible to replace original carburettor jets for another size.

Reworking of the parts is allowed within the manufacture geometrical dimension tolerances as from the technical schedule provided by the manufacturer.

In order not to modify the crankshaft balancing of the standard production engine it is not allowed to remove or add material, in any way, to the components of crankshaft, connecting rods, complete pistons, bearings and pins assembly.

Apart from the above provisions, it is absolutely forbidden to make any alterations to the engine manufacturers standard components either by removal or addition of material. In particular this includes components being subjected to any form of machining, grinding, hand tooling, reworking, reshaping, fettling, polishing etc. unless it is specifically permitted.

The driver is responsible for the condition of the engine as raced. Errors on the part of one manufacturer, mechanic or previous owner is no excuse.(528.10.19)

Post race inspection should follow rules 502.2

4. PROPELLER

The propeller must not have more than 4 (four) blades.

5. FUEL

The fuel must be of commercial type used for automobile. Lubricating oil for cylinder head or for 2-stroke motors may be added to the fuel.

The use of additives aiming at increasing the power of the motor is prohibited either to the fuel (carburant) or to the air intake (comburant).

No refuelling will be allowed when the boat is not on its trailer.

When fuel is available at race site, minimum 92 octane, and the specification and price is printed in the advance programme, all competitors must use the specified fuel.

6. YELLOW CARDS

Yellow cards can only be given for the behaviour on the water. A yellow card will be confirmed on a form which will be posted with the results. The pilot has 60 minutes to protest to the jury. If the protest is not accepted, he can appeal. Protests and appeals can be lodged according to U.I.M. rules.

A yellow card can be given by:

- the Officer of the Day
- the U.I.M. Commissioner

The yellow card can be given according to the following:

- up to two yellow cards at a time for dangerous driving.
- red card for extremely dangerous driving

A driver who has been given three yellow cards or a red card loses his right to take part in the following competition of the World Championship (current season or following season).

All cards remain valid for the four following competitions of the Championship as from the date on which the last card was delivered. When the penalty of not racing at the next race has been applied, the 3 yellow cards are deleted through the penalty.

Timed trials, qualification race and final race count as one event.

An organiser/N.A. who has given one or more yellow cards to a driver must inform U.I.M. by telefax or mail within 3 days. U.I.M. will inform the next organiser/N.A. of a World Championship race or the Continental Championship about the delivery of such yellow cards. When a driver has done 4 races without yellow cards, his previous card(s) will be deleted from the listing.

Given yellow cards must be mentioned in the commissioner's report which must be distributed to all members of the relevant U.I.M. Formula commissioners panel.

7. COMMITTEE OF APPEAL

Appeals will be handled according to the 400 Jurisdiction rules.

The delay to appeal is counted from the moment of the communication of the Jury decision to the interested parties and it is 48 hours.

The 24 hours of the Sunday do not count within the 48 hours to appeal.

Address, telephone and fax should be clearly mentioned on the appeal so that the U.I.M. can send any correspondence directly to the driver with copy to his N.A. The driver may agree on having no Appeal Committee meeting but to handle the appeal through telephone and fax - if possible - in order to limit the costs of the appeal.

8. SAFETY

Before racing a craft with restraint system, all drivers must have passed an immersion test in a restraint system to ensure that they can exit a reinforced compartment successfully.

The immersion certificate should be provided by the National Authority of the driver and includes an immersion test in a simulated reinforced cockpit. The immersion test and the certificate must be renewed every 14 months.

A model for the certificate and instructions of how to perform an immersion test are available at the U.I.M. Secretariat.

All catamaran type hulls must have the deformable pickle forks according to rule 503.02.

Drivers must wear of flotation vest so constructed at the shoulders that a driver can be easily pulled of the cockpit.

Seats are mandatory for F1 cockpits and highly recommended for all other cockpit classes. See 509.08

9. GENERAL

All TV, film, media and commercial rights are the property of the U.I.M.

If the U.I.M. has a contracted promoter, he handles the rights on behalf of the U.I.M.

Any organisation wishing to film or to use existing film must contact the U.I.M. or the promoter.

Any correspondence regarding Formula 1000 must be sent to the following address:

UNION INTERNATIONALE MOTONAUTIQUE
 STADE LOUIS II - ENTREE H
 1 AVENUE DES CASTELANS
 MC 98000 MONACO
 Fax: (377) 92-05-04-60
 E-mail: uim@uimpowerboating.com
 Website: www.uimpowerboating.com

GENERAL FOR ALL FORMULAE RACES **MATCH RACE RULES**

Qualifying from time trial position. (numbers on sheet are timed trial qualifying positions).

Qualifying matrix for 16 boats

- *First elimination round*
- *Quarter-finals*
- *Semi-finals*
- *Third place race*
- *Final*

Qualifying matrix for 8 boats

- *First elimination round*
- *Semi-finals*
- *Third place race*
- *Final*

Course

- *Three pin course (by a straight line)*
- *Round the first turning buoy it should be a sausage buoy (safety zone) to keep the lane for both drivers*
- *The third buoy is the same for both drivers*
- *Finish line is the same for both drivers*
- *Both drivers do one long and one short lap*
- *The longest lap should not be more than 800 m total*

Start

- *By light*
- *From a pontoon*
- *Side by side*
- *Inside driver go for the shortest lap*

- *The outside driver goes for the furthest buoy*
- *With double heat the driver switch lanes*
- *If a driver does not start the other driver must complete the course*

Finish single heat

- *The driver who passing the finish line first is the winner of this Match Race heat, there may be time keeping, if required for minor places overall position.*

Finish double heat

- *The driver who made the best average time is the winner of the double heat*

Penalties (disqualification)

- *Non-start*
- *Jump start*
- *Cutting course*
- *Impeding other course*

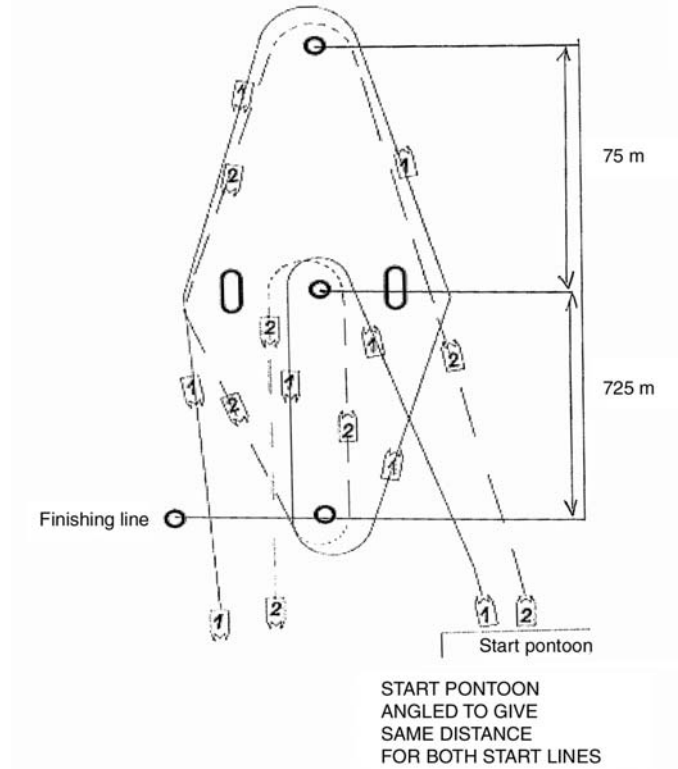
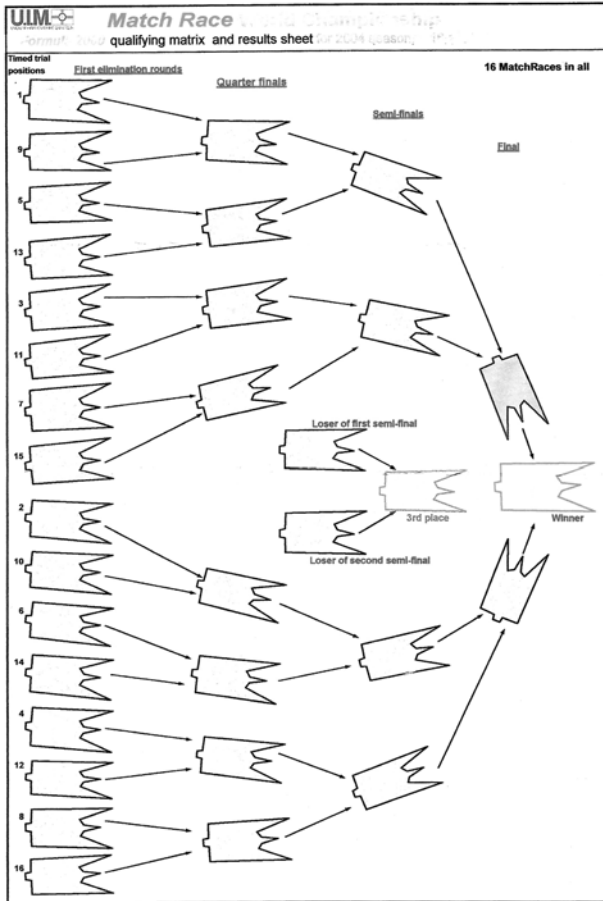

GENERAL FOR ALL FORMULAE RACES **CODE OF PRACTICE FOR SAFETY**

1) RESCUE BOATS

Should be high speed, drop front (dories or similar) which produce a minimum disturbance of the water.

There must be a minimum of two rescue boats along the circuit so placed that they can reach in the minimum possible time any point of the course. Their locations and their co-ordination must be decided in a meeting among the OOD, the Medical Officer, the rescue Teams responsible and the U.I.M. Commissioners before first practice.

These boats shall be equipped as a minimum as follows:

- a floating stretcher,
- belt cutters,
- one fire extinguisher,
- ropes (including tow ropes),
- an anchor,
- an haemostatic strip,
- bandages
- a set of flags,
- red flares.

All these boats shall be in contact with each other, with the medical post and the OOD with a radio equipment that has to be used without interfering with the driving and the rescue operations.

These boats shall not be allowed to carry on towing duties during the practice sessions and the race.

2) CREW MEMBERS

Each boat shall carry the following persons:

- an experienced driver,

- two crew members prepared and equipped to enter the water to support any injured driver and who are familiar with any safety equipment used on racing boats.

No pilot shall be pulled or assisted into any rescue boat; no pilot shall be removed from the water unless the hole body is supported by a stretcher. No other boat shall be allowed to pull or assist any injured driver.

3) MEDICAL ASSISTANCE

A minimum of three doctors are required at each event:

- The Medical Officer, a doctor well introduced in powerboat racing problems acting as the co-ordinator of the medical team;
- a doctor graduated in resuscitation responsible for the medical post where he has to be available during the practice sessions and the race;
- a doctor graduated in resuscitation operating on one of the three rescue boats in addition to the existing crew. He shall carry on the boat all the equipment necessary for first aid assistance (a water sucker, intra tracheal tubes, Mayo cannulae, oxygen supply and do on).

4) GROUND ORGANISATION

Apart from the medical post reserved for the public each event must have a private post (minimum a tent) where an injured driver may be taken after initial resuscitation before being moved to the nearest hospital.

This medical post has to be located as close as possible to the rescue boat landing s' site. This has to be in a reserved area (not accessible to the public) and must be adequate for an easy and safe of the transfer operation injured driver. It is very important that the landing site and the medical post are located close to the race course even if far from the pits area. A nearby closed area for an helicopter is recommended.

A minimum of two ambulances is required. At least one of them must be equipped as a mobile resuscitation centre. They will be located close to the medical post and must have easy and constantly open access from the medical post to the road leading to the hospital.

A general hospital shall be informed about the Event and prepared to take care of an injured driver.

The Medical Officer, according to any specific situation, may ask the OOD to adjust the rescue and medical organisation (increasing the number of rescue boats, ambulances and doctors) in order to maintain a minimum standard of assistance.

The presence and the employment of local teams able to work with the required equipment and efficiency are recommended.

ELECTIONS OF THE DRIVERS' DELEGATE FOR F1, F2000

The election must be held in the presence of a U.I.M. official. The candidate must be a real driver (4 races or 40% of the total rounded up to the next unit); he is elected for a three year period provided he keeps within the limits of eligibility. The drivers' assembly may intervene if the delegate is not suitable any longer.

U.I.M. SUPERLICENCE MEDICAL CERTIFICATE FOR ALL FORMULAE DRIVERS

I, Doctor..... Specialist in

Hereby declare that Mr

Born in On

Nationality Passport number

Has carried out the medical examination as in 205.03 / 04 of the U.I.M. Circuit Rules.

In addition, Mr has carried out the additional items indicated at rule 205.04.1 of the U.I.M. Circuit Rules.

The results of the tests are normal and I therefore declare the driver eligible for racing.

The reports of the tests carried out can be consulted in the next five years at my surgery.

This certificate is valid for one year from today's date.

Date

Stamp with address of the doctor
Or of the Clinic

Signature of the Doctor

GENERAL RECOMMENDATION FOR ALL FORMULAE SUPER LICENCE HOLDERS

- Cardiovascular training (endurance training) as jogging, cycling, rowing etc. twice a week – minimum 20 minutes without any interruption. Any sports activity which has "stand still" during the activity such as soccer, tennis or any ball sport is not suitable for the endurance training, but recommended as additional training.

- Training to build up muscles for neck and back at least twice a week.

Achévé d'imprimer sur les presses de
MULTIPRINT - MONACO
en février 2007
(62186)